



### Description

The HSH120N20 is the highest performance trench N-ch MOSFETs with extreme high cell density, which provide excellent R<sub>DS(ON)</sub> and gate charge for most of the synchronous buck converter applications.

The HSH120N20 meet the RoHS and Green Product requirement, 100% EAS guaranteed with full function reliability approved.

- Power Switching application
- Green Device Available
- Excellent Cdv/dt effect decline
- Advanced high cell density Trench technology

### Product Summary

V <sub>DS</sub>	200	V
R <sub>DS(ON),typ</sub>	8.9	mΩ
I <sub>D</sub>	120	A

### TO263 Pin Configuration

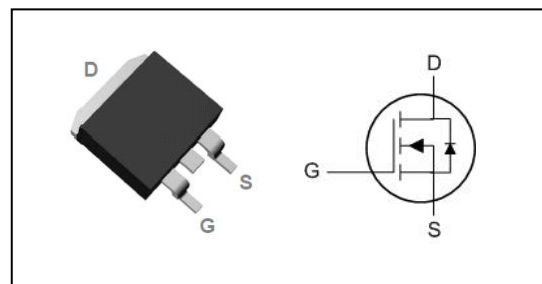

### Absolute Maximum Ratings

Symbol	Parameter	Rating	Units
V <sub>DS</sub>	Drain-Source Voltage	200	V
V <sub>GS</sub>	Gate-Source Voltage	± 20	V
I <sub>D</sub> @T <sub>C</sub> =25°C	Continuous Drain Current, V <sub>GS</sub> @ 10V <sup>1</sup>	120	A
I <sub>D</sub> @T <sub>C</sub> =100°C	Continuous Drain Current, V <sub>GS</sub> @ 10V <sup>1</sup>	92	A
I <sub>DM</sub>	Pulsed Drain Current <sup>2</sup>	520	A
EAS	Single Pulse Avalanche Energy <sup>3</sup>	845	mJ
P <sub>D</sub> @T <sub>C</sub> =25°C	Total Power Dissipation <sup>3</sup>	500	W
T <sub>STG</sub>	Storage Temperature Range	-55 to 150	°C
T <sub>J</sub>	Operating Junction Temperature Range	-55 to 150	°C

### Thermal Data

Symbol	Parameter	Typ.	Max.	Unit
R <sub>θJA</sub>	Thermal Resistance Junction-ambient <sup>1</sup>	---	60	°C/W
R <sub>θJC</sub>	Thermal Resistance Junction-Case <sup>1</sup>	---	0.36	°C/W



### Electrical Characteristics (T<sub>J</sub>=25 °C, unless otherwise noted)

Symbol	Parameter	Conditions	Min.	Typ.	Max.	Unit
BV <sub>DSS</sub>	Drain-Source Breakdown Voltage	V <sub>GS</sub> =0V, I <sub>D</sub> =250uA	200	---	---	V
R <sub>DS(ON)</sub>	Static Drain-Source On-Resistance <sup>2</sup>	V <sub>GS</sub> =10V, I <sub>D</sub> =20A	---	8.9	11	mΩ
V <sub>GS(th)</sub>	Gate Threshold Voltage	V <sub>GS</sub> =V <sub>DS</sub> , I <sub>D</sub> =250uA	2.5	3.3	4.5	V
I <sub>DSS</sub>	Drain-Source Leakage Current	V <sub>DS</sub> =200V, V <sub>GS</sub> =0V, T <sub>J</sub> =25°C	---	---	1	uA
		V <sub>DS</sub> =200V, V <sub>GS</sub> =0V, T <sub>J</sub> =55°C	---	---	5	
I <sub>GSS</sub>	Gate-Source Leakage Current	V <sub>GS</sub> = ± 20V, V <sub>DS</sub> =0V	---	---	± 100	nA
R <sub>g</sub>	Gate Resistance	V <sub>DS</sub> =0V, V <sub>GS</sub> =0V, f=1MHz	---	5.0	---	Ω
Q <sub>g</sub>	Total Gate Charge (10V)	V <sub>DS</sub> =100V, V <sub>GS</sub> =10V, I <sub>D</sub> =20A	---	46	---	nC
Q <sub>gs</sub>	Gate-Source Charge		---	20	---	
Q <sub>gd</sub>	Gate-Drain Charge		---	12	---	
T <sub>d(on)</sub>	Turn-On Delay Time	V <sub>DD</sub> =100V, V <sub>GS</sub> =10V, R <sub>G</sub> =2.5Ω I <sub>D</sub> =20A	---	21	---	ns
T <sub>r</sub>	Rise Time		---	22	---	
T <sub>d(off)</sub>	Turn-Off Delay Time		---	32	---	
T <sub>f</sub>	Fall Time		---	23	---	
C <sub>iss</sub>	Input Capacitance	V <sub>DS</sub> =50V, V <sub>GS</sub> =0V, f=1MHz	---	3520	---	pF
C <sub>oss</sub>	Output Capacitance		---	467	---	
C <sub>rss</sub>	Reverse Transfer Capacitance		---	37	---	

### Diode Characteristics

Symbol	Parameter	Conditions	Min.	Typ.	Max.	Unit
I <sub>S</sub>	Continuous Source Current <sup>1,5</sup>	V <sub>G</sub> =V <sub>D</sub> =0V, Force Current	---	---	120	A
V <sub>SD</sub>	Diode Forward Voltage <sup>2</sup>	V <sub>GS</sub> =0V, I <sub>S</sub> =30A, T <sub>J</sub> =25°C	---	---	1.2	V
T <sub>rr</sub>	Body Diode Reverse Recovery Time	I <sub>F</sub> = 15A, dI <sub>F</sub> /dt = 100A/s	---	133	---	ns
Q <sub>rr</sub>	Body Diode Reverse Recovery Charge	I <sub>F</sub> = 15A, dI <sub>F</sub> /dt = 100A/s	---	677	---	nC

Note :

- 1.The data tested by surface mounted on a 1 inch<sup>2</sup> FR-4 board with 2OZ copper.
- 2.The data tested by pulsed , pulse width ≤ 300us , duty cycle ≤ 2%
- 3.The EAS data shows Max. rating . The test condition is V<sub>DD</sub>=25V,V<sub>GS</sub>=10V,L=0.5mH
- 4.The power dissipation is limited by 150°C junction temperature
- 5.The data is theoretically the same as I<sub>D</sub> and I<sub>DM</sub> , in real applications , should be limited by total power dissipation.



## N-Ch 200V Fast Switching MOSFETs

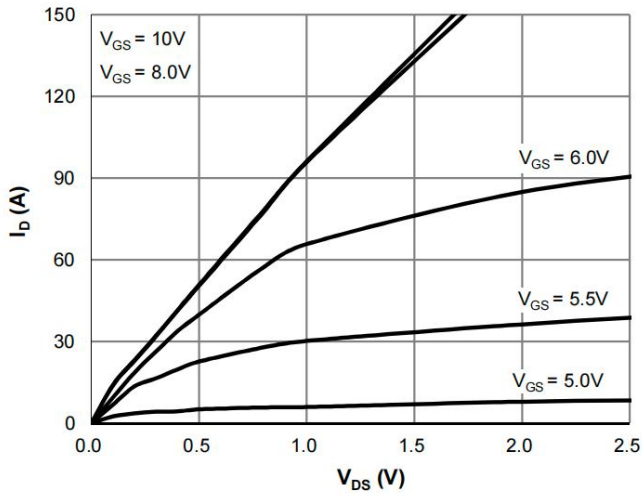

Figure 1: Saturation Characteristics

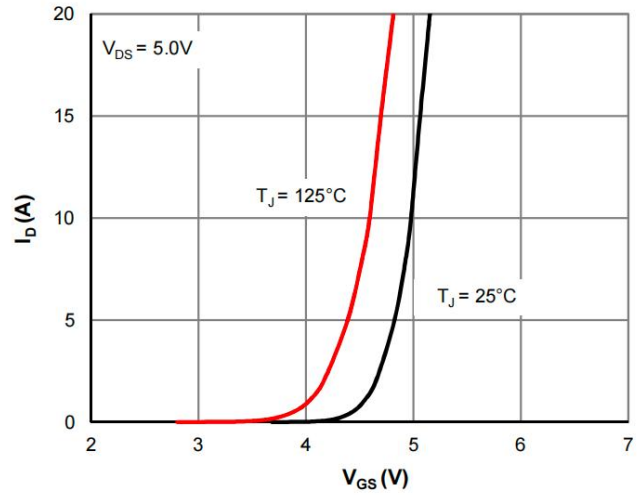

Figure 2: Transfer Characteristics

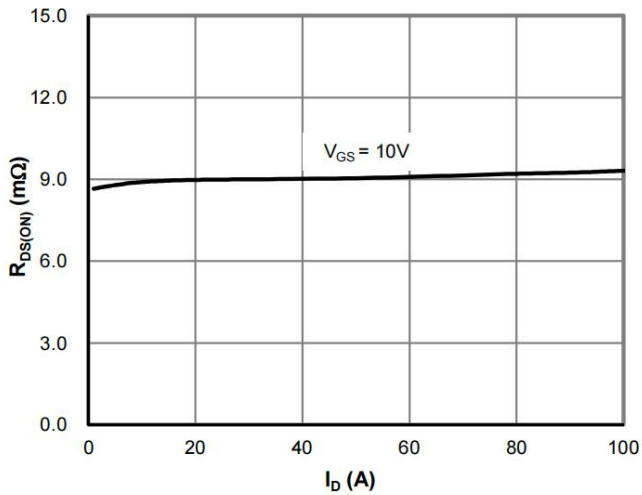

Figure 3:  $R_{DS(ON)}$  vs. Drain Current

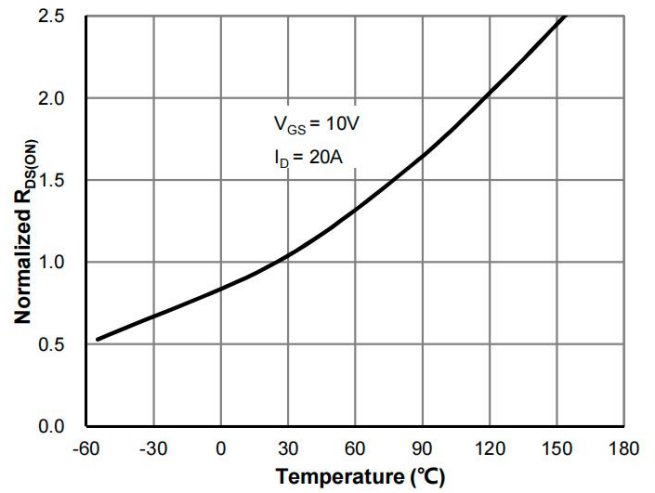

Figure 4:  $R_{DS(ON)}$  vs. Junction Temperature

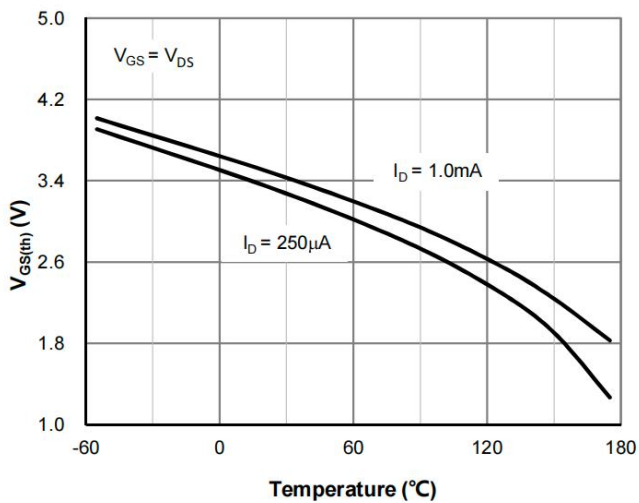

Figure 5:  $V_{GS(th)}$  vs. Junction Temperature

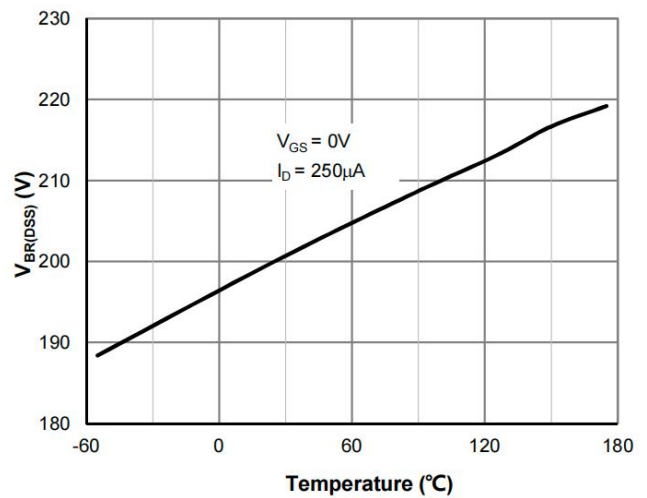

Figure 6:  $V_{BR(DSS)}$  vs. Junction Temperature

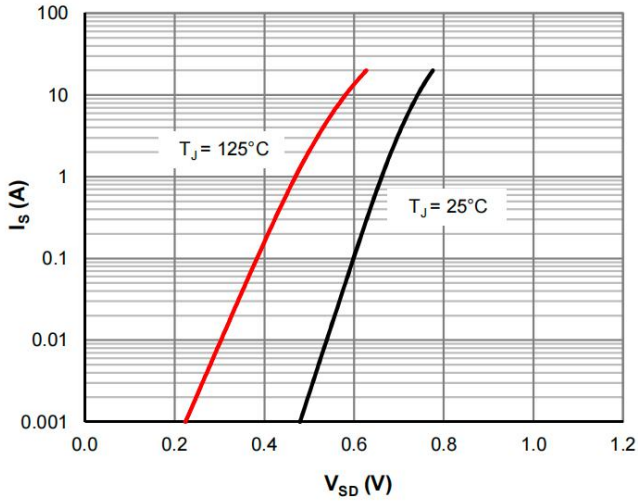

Figure 7: Body-Diode Characteristics

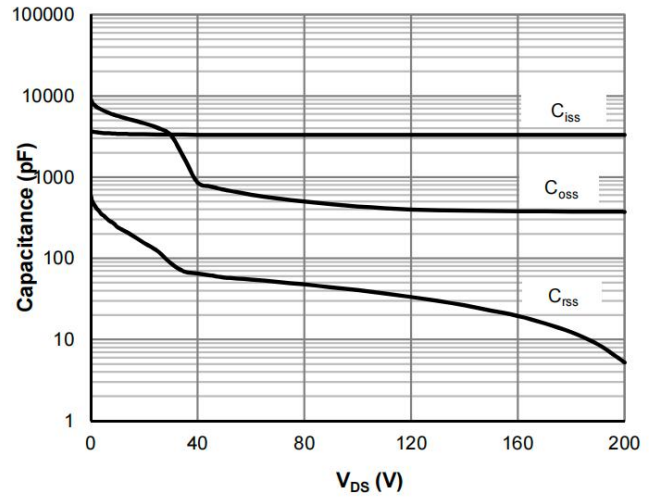

Figure 8: Capacitance Characteristics

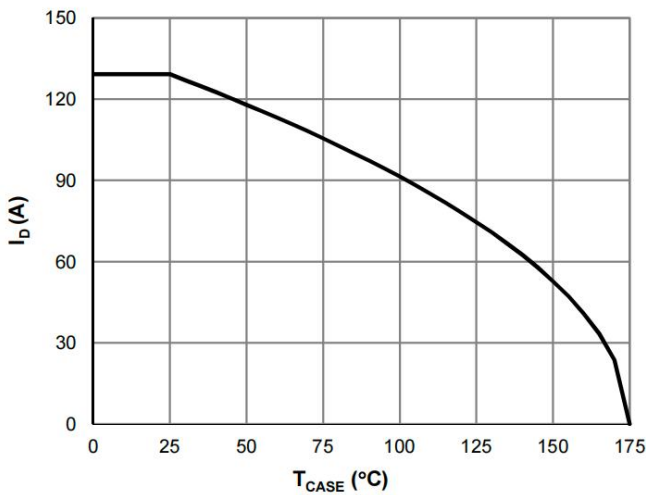

Figure 9: Current De-rating

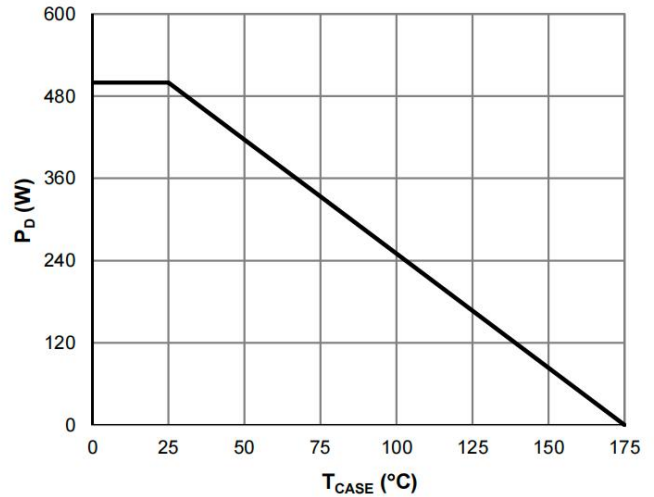

Figure 10: Power De-rating

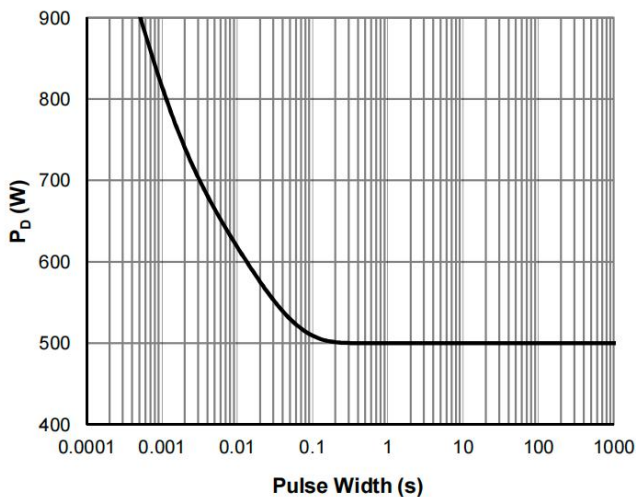

Figure 11: Single Pulse Power Rating, Junction-to-Case

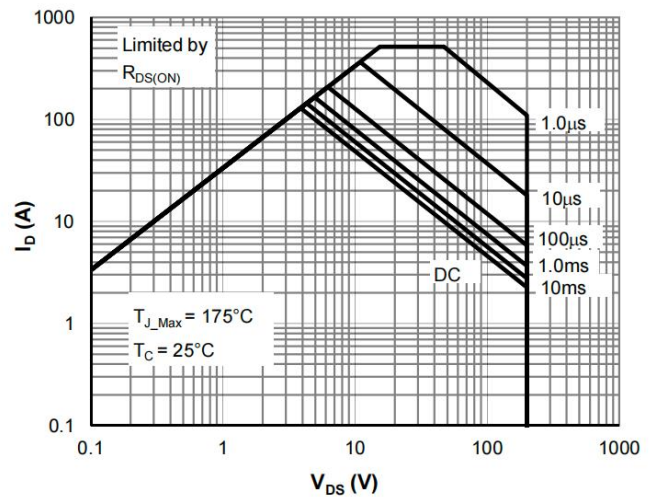

Figure 12: Maximum Safe Operating Area

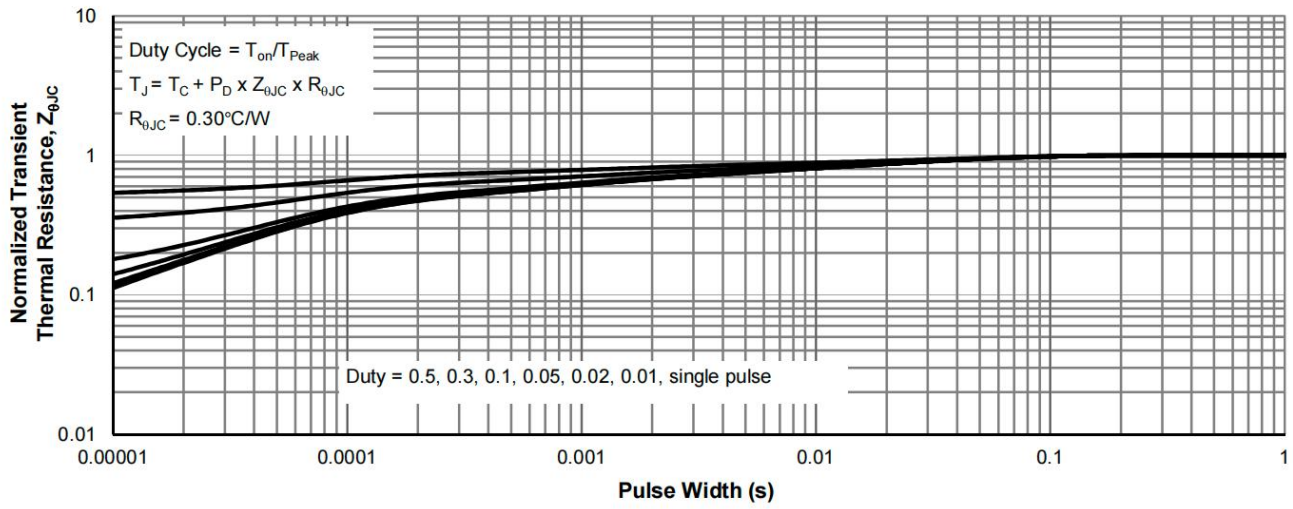
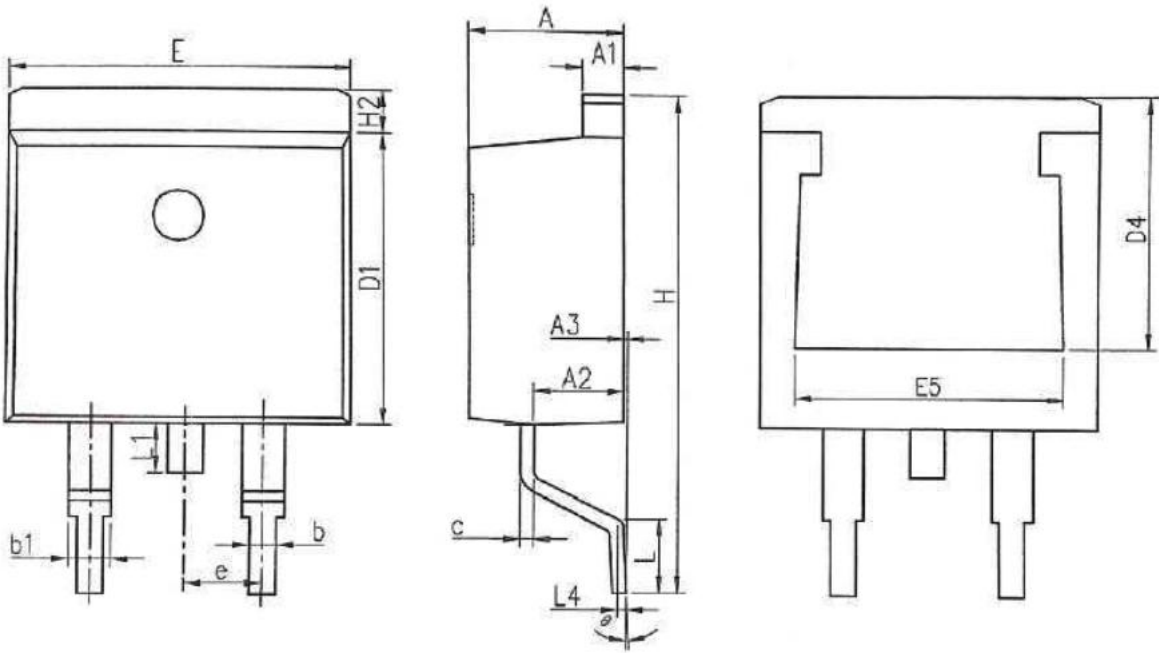

Figure 13: Normalized Maximum Transient Thermal Impedance



SYMBOLS	MILLIMETERS		INCHES	
	MIN	MAX	MIN	MAX
A	4.370	4.770	0.172	0.188
A1	1.220	1.420	0.048	0.056
A2	2.200	2.890	0.087	0.114
A3	0.000	0.250	0.000	0.010
b	0.700	0.960	0.028	0.038
b1	1.170	1.470	0.046	0.058
c	0.300	0.530	0.012	0.021
D1	8.500	9.300	0.335	0.366
D4	6.600	-	0.260	-
E	9.860	10.36	0.388	0.408
E5	7.060	-	0.278	-
e	2.540 BSC		0.100 BSC	
H	14.70	15.70	0.579	0.618
H2	1.070	1.470	0.042	0.058
L	2.000	2.600	0.079	0.102
L1	1.400	1.750	0.055	0.069
L4	0.250 BSC		0.010 BSC	
Θ	0°	9°	0°	9°