

1.材料和电镀\Materials and Finishes:

外壳\Body - 黄铜\Brass,镀金\Gold plating  
 内导体>Contact - 磷铜\Phosphor copper,镀金\Gold plating  
 绝缘体\Insulator - 聚四氟乙烯\Teflon,本色\Natural





2.电气性能\Electrical:

A.特性阻抗\Impedance:50 Ohm  
 B.使用频率\Frequency range:DC-3GHz  
 C.介质耐压\Breakdown voltage:500V rms  
 D.绝缘电阻\Insulation resistance:1000 MΩ

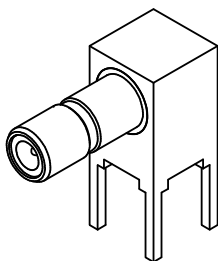
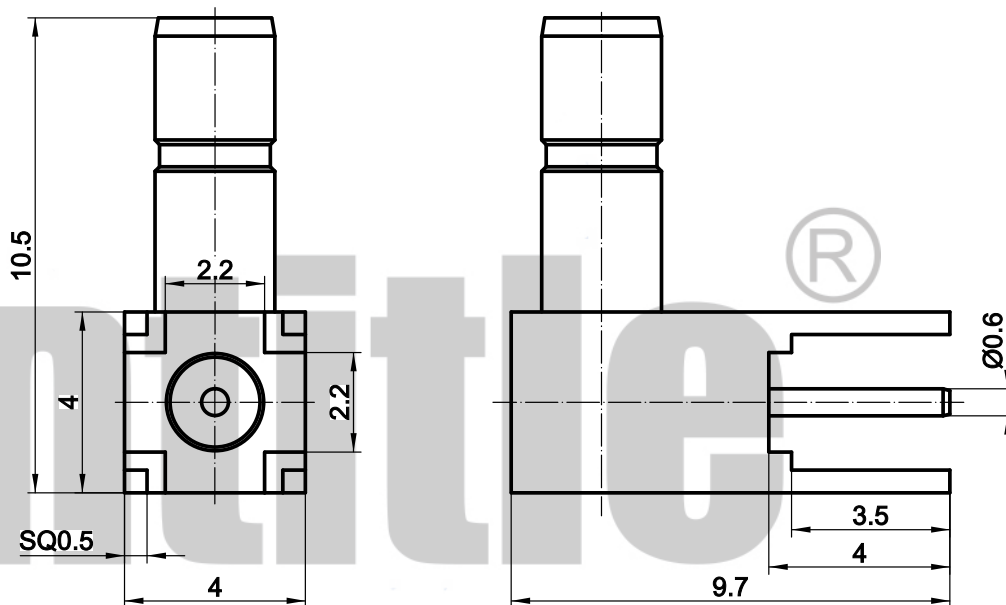
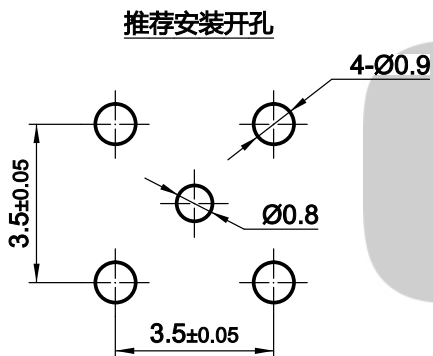
3.机械性能\Mechanical:

A.使用寿命\Durability:500 cycles  
 B.中性盐雾\Salt spray:72 hours



 技术支持 13975145315		版次	比例	6:1	料号	CT3.660.725		
		第一角法			规格	SSMB-JWE-5		
设计	JAT	2024.01.20	1.未注公差按ISO2768-1(m) 2.去尽毛刺C0.13max 3.各圆同轴度Ø0.1max			名称	SSMB弯公头四脚焊接PCB	
审核	DF	2024.01.20				*尺寸为重要尺寸		 深圳成泰电子有限公司 www.cntitle.net
批准	DF	2024.01.20						