

MBR30U100CT, MBR30U100FCT
SCHOTTKY BARRIER RECTIFIERS



VOLTAGE: 80 Volts

CURRENT: 30.0 Amperes

Marking and Polarity

FEATURES

- Low forward voltage drop for high efficiency
- Low power loss for high reliability
- High forward surge capability for high reliability
- High frequency operation
- Solder bath temperature 260°C maximum, 10s, per JESD22-B106
- Component in accordance to RoHS 2011/65/EU

MECHANICAL DATA

- **Terminals:** Plated Leads Solderable per MIL-STD-202, Method 208
- **Mounting Position:** Any
- **Lead Free:** Lead Free Finish, RoHS Compliant
- **Polarity:** As marked

TYPICAL APPLICATIONS

- For use in high frequency inverters ,Switch power supply AC/DC converters, LED driver etc. applications

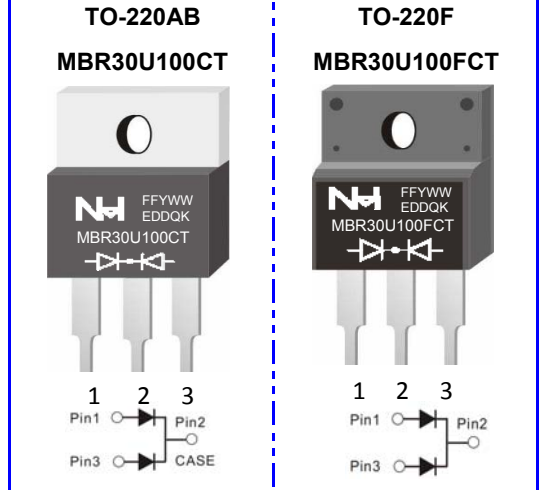

Remark:

- ①. NH=niuhang trademark;
- ②. FF=Product line code, According to actual changes
YWW=Date code, According to actual changes
EDDQK=Internal code, According to actual changes
- ③. MBR30U100CT/FCT=Model.

Maximum Ratings (Ratings at 25°C ambient temperature unless otherwise specified)

Parameter	Symbol	MBR30U100CT, MBR30U100FCT	Unit
Maximum repetitive peak reverse voltage	V_{RRM}	80	V
Maximum average forward rectified current (see fig.1)	$I_{F(AV)}$	30	A
Peak forward surge current 8.3ms single half sine-wave superimposed on rated load (JEDEC method at rated TL)	I_{FSM}	280	A
Peak repetitive reverse current per diode at $t_p=2\mu s$ 1KHz	I_{RRM}	50	μA

Electrical Characteristics (Ratings at 25°C ambient temperature unless otherwise specified)

Parameter	Test Conditions	Symbol	MBR30U100CT, MBR30U100FCT			Unit	
			Min.	Typ.	Max.		
Instantaneous forward voltage per diode (note1)	$T_A=25^\circ C$	$I_F=15 A$	V_F	--	0.65	0.72	V
	$T_A=125^\circ C$			--	0.57	0.67	
Reverse current per diode (note1)	$T_A=25^\circ C$	$V_R=V_{RRM}$ $V_R=80\% \cdot V_{RRM}$	I_R	--	20	50	μA
	$T_A=125^\circ C$			--	2	5	mA
Typical junction capacitance	4V, 1MHz	C_J	--	650	--	pF	

Thermal Characteristics (Ratings at 25°C ambient temperature unless otherwise specified)

Parameter	Symbol	MBR30U100CT, MBR30U100FCT	Unit
Operating junction	T_J	-55 to 150	°C
Storage temperature range	T_{STD}	-55 to 150	
Typical thermal resistance (note2)	$R_{\theta JC}$	TO-220AB	°C/W
		2.5	

- Notes:
1. Pulse test: 300 μs pulse width, 1% duty cycle
 2. Device mounted on Device mounted on 75mm x 45mm x 2.5mm Aluminum Plate Heatsink.

MBR30U100CT, MBR30U100FCT
SCHOTTKY BARRIER RECTIFIERS



RATING AND CHARACTERISTIC CURVES

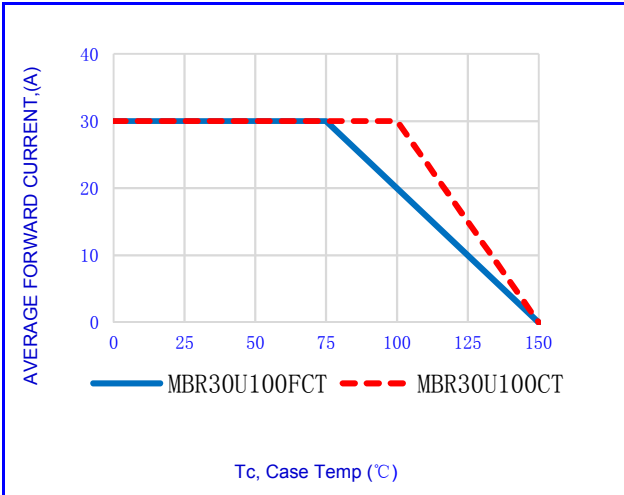

Fig.1-FORWARD CURRENT DERATING CURVE

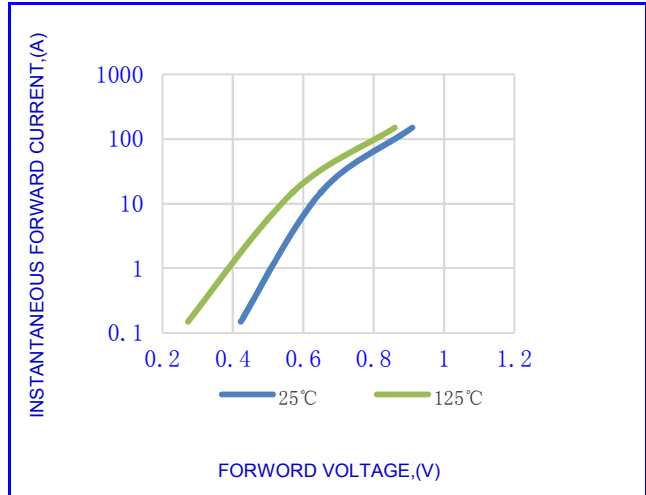

Fig.2- TYPICAL INSTANTANEOUS FORWARD

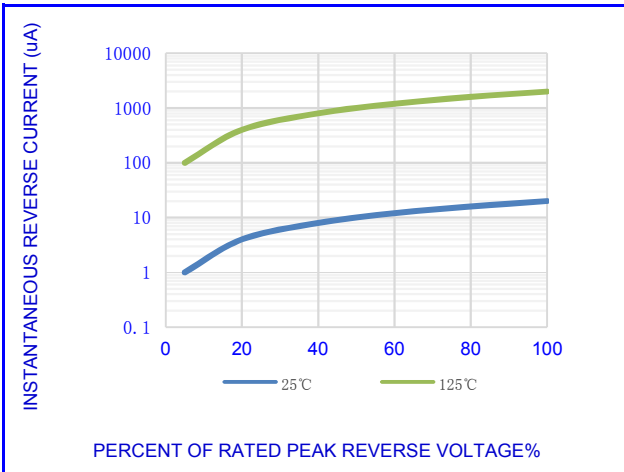

Fig.3- TYPICAL REVERSE CHARACTERISTICS

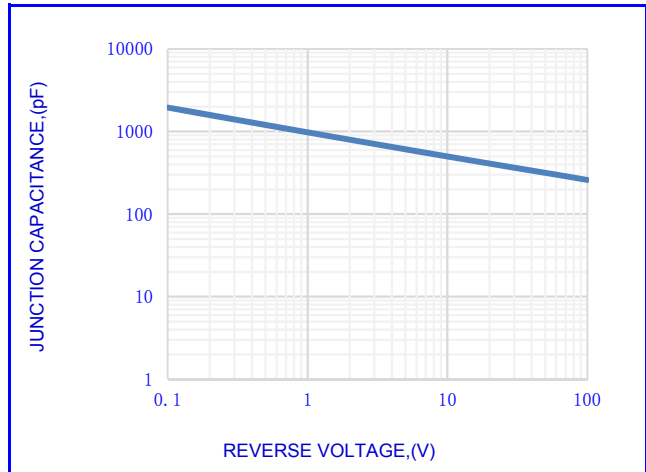

Fig.4- TYPICAL JUNCTION CAPACITANCE

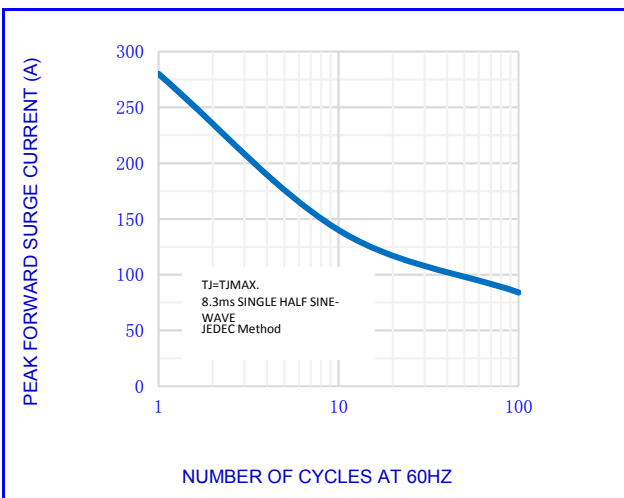

Fig.5-MAX. NON-REPETITIVE SURGE CURRENT

MBR30U100CT, MBR30U100FCT
SCHOTTKY BARRIER RECTIFIERS



OUTLINE DRAWINGS

TO-220AB

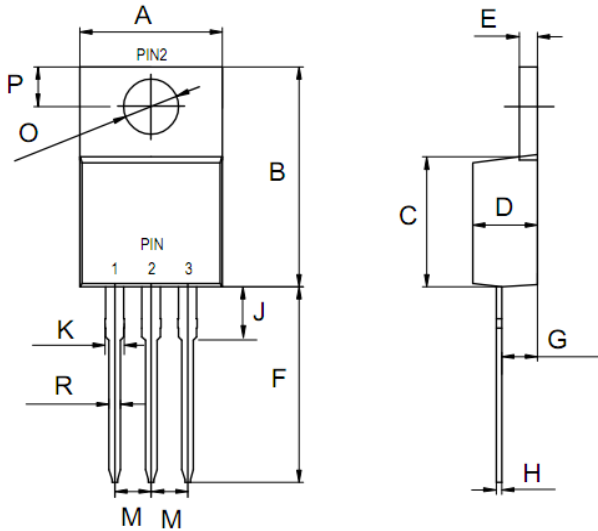

OUTLINE DIMENSIONS						
Dim.	Millimeters			Inches		
	Min.	Typ.	Max.	Min.	Typ.	Max.
A	9.80	-	10.40	0.3858	-	0.4094
B	14.95	-	15.50	0.5886	-	0.6102
C	8.40	-	9.40	0.3307	-	0.3701
D	4.20	-	4.70	0.1654	-	0.1850
E	1.15	-	1.45	0.0453	-	0.0571
F	12.50	-	-	0.4921	-	-
G	2.30	-	2.70	0.0906	-	0.1063
H	0.30	-	0.45	0.0118	-	0.0177
J	3.00	-	4.50	0.1181	-	0.1772
M	2.44	-	2.64	0.0961	-	0.1039
R	0.70	-	1.00	0.0276	-	0.0394
O	3.45	-	3.85	0.1358	-	0.1516
P	2.80	-	3.20	0.1102	-	0.1260

OUTLINE DRAWINGS

TO-220F

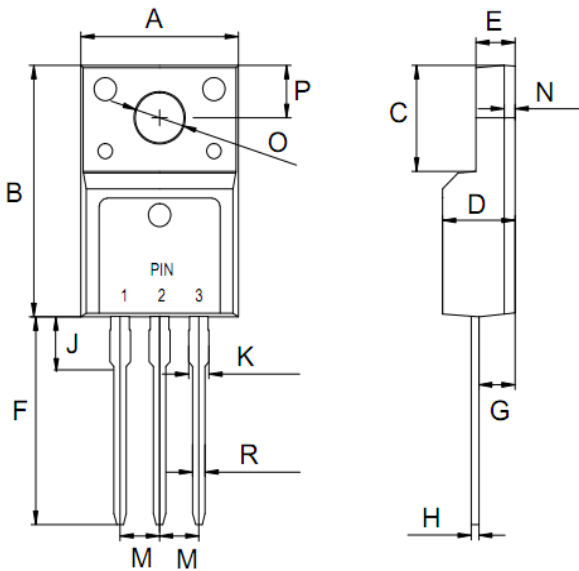

OUTLINE DIMENSIONS						
Dim.	Millimeters			Inches		
	Min.	Typ.	Max.	Min.	Typ.	Max.
A	9.91	10.21	10.41	0.3902	0.4020	0.4098
B	15.30	16.00	16.50	0.6024	0.6299	0.6496
C	6.20	6.75	7.20	0.2441	0.2657	0.2835
D	4.44	4.70	4.80	0.1748	0.1850	0.1890
E	2.45	2.57	3.55	0.0965	0.1012	0.1398
F	12.50	13.50	14.50	0.4921	0.5315	0.5709
G	2.25	2.40	2.60	0.0886	0.0945	0.1024
H	0.35	0.50	0.58	0.0138	0.0197	0.0228
J	2.60	2.88	4.00	0.1024	0.1134	0.1575
M	2.41	2.50	2.67	0.0949	0.0984	0.1051
N	4.88	5.00	5.28	0.1921	0.1969	0.2079
R	0.58	0.82	0.94	0.0228	0.0323	0.0370
O	3.25	3.55	3.75	0.1280	0.1398	0.1476
P	2.15	3.30	3.50	0.0846	0.1299	0.1378

PACKING INFORMATION

Package Code	Package Method	Tube Size L×W×H(mm)	Quantity (pcs/Tube)	Inner Box Size L×W×H(mm)	Quantity (pcs/Inner Box)	Outer Carton Size L×W×H(mm)	Quantity (pcs/carton)
TO-220AB	Tube	530x35x8	50	560x155x55	1000	570×284×185	5000
TO-220F	Tube	530x35x8	50	560x155x55	1000	570×284×185	5000

MBR30U100CT, MBR30U100FCT
SCHOTTKY BARRIER RECTIFIERS



Recommended wave soldering condition

Product	Peak Temperature	Soldering Time
Pb-free devices	260 +0/-5 °C	5 +1/-1 seconds

Recommended temperature profile for IR reflow

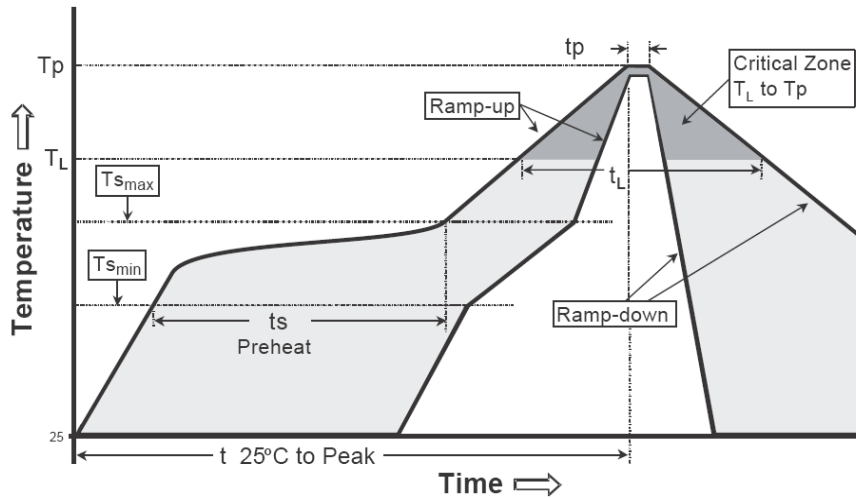

Profile feature	Sn-Pb eutectic Assembly	Pb-free Assembly
Average ramp-up rate (T _{smax} to T _p)	3°C/second max.	3°C/second max.
Preheat -Temperature Min(T _S min) -Temperature Max(T _S max) -Time(t _s min to t _s max)	100°C 150°C 60-120 seconds	150°C 200°C 60-180 seconds
Time maintained above: -Temperature (T _L) - Time (t _L)	183°C 60-150 seconds	217°C 60-150 seconds
Peak Temperature(T _P)	240 +0/-5 °C	260 +0/-5 °C
Time within 5°C of actual peak temperature(tp)	10-30 seconds	20-40 seconds
Ramp down rate	6°C/second max.	6°C/second max.
Time 25 °C to peak temperature	6 minutes max.	8 minutes max.

Note : All temperatures refer to topside of the package, measured on the package body surface.

MBR30U100CT, MBR30U100FCT
SCHOTTKY BARRIER RECTIFIERS



Disclaimer

- Reproducing and modifying information of the document is prohibited without permission from niuhang Electronics co., LTD
- Niuhan Electronics co., LTD. reserves the rights to make changes of the content herein the document anytime without notification.
- Niuhan Electronics co., LTD. disclaims any and all liability arising out of the application or use of any product including damages incidentally and consequentially occurred.
- Niuhan Electronics co., LTD. does not assume any and all implied warranties, including warranties of fitness for particular purpose, non-infringement and merchantability.
- Applications shown on the herein document are examples of standard use and operation. Customers are responsible in comprehending the suitable use in particular applications. Niuhan Electronics co., LTD. makes no representation or warranty that such applications will be suitable for the specified use without further testing or modification.
- The products shown herein are not designed and authorized for equipments requiring high level of reliability or relating to human life and for any applications concerning life-saving or life-sustaining, such as medical instruments, transportation equipment, aerospace machinery et cetera. Customers using or selling these products for use in such applications do so at their own risk and agree to fully indemnify Niuhan Electronics co., LTD. for any damages resulting from such improper use or sale.
- When the appearance of the product and chip size does not change, in order to product the customer. quality, change the internal structure and the production process Niuhan can not notify