

BRCS035N03ZC

Rev.A Dec.-2023

描述 / Descriptions

PDFN5×6 封装 N 沟道场效应管。

N-Channel MOSFET in a PDFN5×6 Plastic Package.

特征 / Features

$V_{DS}(V)=30\text{ V}$ $I_D=95\text{ A}$

$R_{DS(ON)}@10\text{ V}\leq 3.6\text{ m}\Omega$ (Typ.3.5mR)

$R_{DS(ON)}@4.5\text{ V}\leq 6.5\text{ m}\Omega$ (Typ.5.0mR)

无卤产品。HF Product.

用途 / Applications

电池管理，MB/NB/UMPC/VGA 高频负载点同步 Buck 变换器，联网直流-直流电力系统，负荷开关。

Battery Management, High Frequency Point-of-Load Synchronous Buck Converter for

MB/NB/UMPC/VGA, Networking DC-DC Power System, Load Switch.

内部等效电路 / Equivalent Circuit

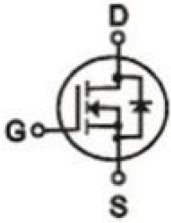

引脚排列 / Pinning

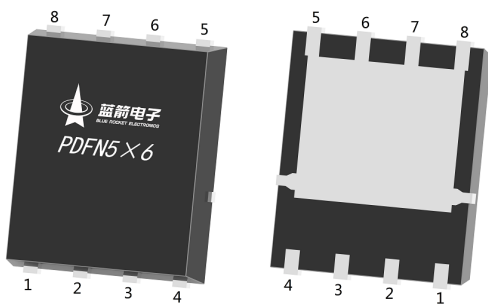

PIN1、2、3: S PIN4: G PIN5、6、7、8: D

印章代码 / Marking

见印章说明。

See Marking Instructions.

极限参数 / Absolute Maximum Ratings($T_a=25^{\circ}\text{C}$)

| 参数 Parameter | 符号 Symbol | 数值 Rating | 单位 Unit |
|--|-------------------------------|-----------------|--------------------|
| Drain-Source Voltage | V_{DS} | 30 | V |
| Continuous Drain Current | I_D | 95 | A |
| Pulsed Drain Current | I_{DM} | 175 | A |
| Gate-Source Voltage | V_{GS} | ± 20 | V |
| Power Dissipation | $P_D(T_c=25^{\circ}\text{C})$ | 55 | W |
| Avalanche energy(L=0.5mH) | E_{AS} | 281 | mJ |
| Avalanche Current(L=0.5mH) | I_{AS} | 26.5 | A |
| Junction and Storage Temperature Range | T_j, T_{stg} | -55 to 150 | $^{\circ}\text{C}$ |
| Maximum Junction-to-Ambient | $t \leq 10\text{s}$ | $R_{\theta JA}$ | 25 |
| | Steady-State | | 55 |
| Maximum Junction-to-Case | Steady-State | $R_{\theta JC}$ | 2.3 |

电性能参数 / Electrical Characteristics($T_a=25^{\circ}\text{C}$)

| 参数 Parameter | 符号 Symbol | 测试条件 Test Conditions | 最小值 Min | 典型值 Typ | 最大值 Max | 单位 Unit |
|-----------------------------------|--------------|--|------------|------------|------------|---------------|
| Drain-Source Breakdown Voltage | BV_{DSS} | $I_D=250\mu\text{A}, V_{GS}=0\text{V}$ | 30 | 33 | | V |
| Zero Gate Voltage Drain Current | I_{DSS} | $V_{DS}=30\text{V}, V_{GS}=0\text{V}$ | | | 1.0 | μA |
| Gate-Body leakage current | I_{GSS} | $V_{DS}=0\text{V}, V_{GS}=\pm 20\text{V}$ | | | ± 100 | nA |
| Gate Threshold Voltage | $V_{GS(th)}$ | $V_{DS}=V_{GS}, I_D=250\mu\text{A}$ | 1 | 1.7 | 3.0 | V |
| Static Drain-Source On-Resistance | $R_{DS(ON)}$ | $V_{GS}=10\text{V}, I_D=20\text{A}$ | | 3.5 | 3.6 | m Ω |
| | | $V_{GS}=4.5\text{V}, I_D=10\text{A}$ | | 5.0 | 6.5 | |
| Diode Forward Voltage | V_{SD} | $I_S=1\text{A}, V_{GS}=0\text{V}$ | | | 1.4 | V |
| Input Capacitance | C_{iss} | $V_{DS}=25\text{V}, V_{GS}=0\text{V}$ $f=1.0\text{MHz}$ | | 2200 | | pF |
| Output Capacitance | C_{oss} | | | 145 | | |
| Reverse Transfer Capacitance | C_{rss} | | | 210 | | |
| Gate resistance | R_g | $V_{GS}=0\text{V}, V_{DS}=0\text{V}$ $f=1\text{MHz}$ | | 2.0 | | Ω |

电性能参数 / Electrical Characteristics(Ta=25°C)

| 参数 Parameter | 符号 Symbol | 测试条件 Test Conditions | 最小值 Min | 典型值 Typ | 最大值 Max | 单位 Unit |
|---------------------|---------------|---|------------|------------|------------|------------|
| Total Gate Charge | $Q_{g(10V)}$ | $V_{GS}=10V$ $V_{DS}=15V$ $I_D=20A$ | | 32 | | nC |
| Total Gate Charge | $Q_{g(4.5V)}$ | | | 15 | | |
| Gate Source Charge | Q_{gs} | | | 5.2 | | |
| Gate Drain Charge | Q_{gd} | | | 6.5 | | |
| Turn-On Delay Time | $t_{d(on)}$ | $V_{GS}=10V$ $V_{DS}=15V$ $R_L=0.75 \Omega$ $R_{GEN}=3 \Omega$ | | 8.5 | | ns |
| Turn-On Rise Time | t_r | | | 4.2 | | |
| Turn-Off Delay Time | $t_{d(off)}$ | | | 30 | | |
| Turn-Off Fall Time | t_f | | | 5.7 | | |

电参数曲线图 / Electrical Characteristic Curve

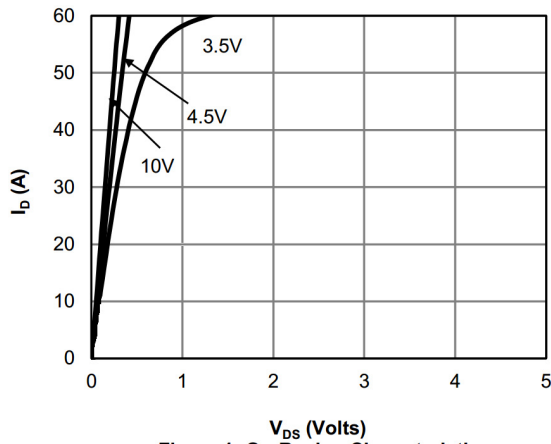

Figure 1: On-Region Characteristics

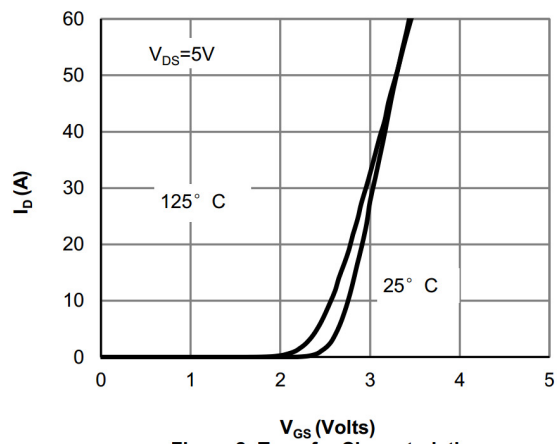

Figure 2: Transfer Characteristics

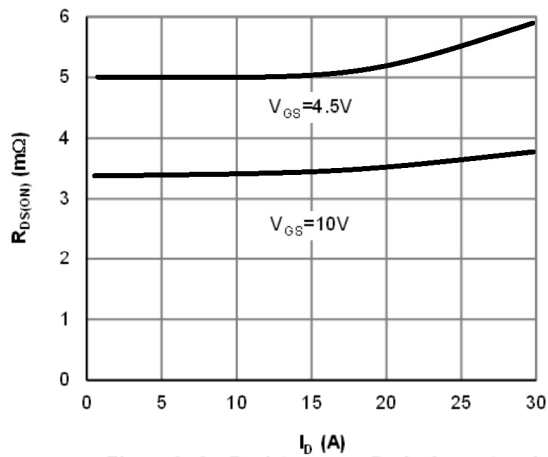

Figure 3: On-Resistance vs. Drain Current and Gate Voltage

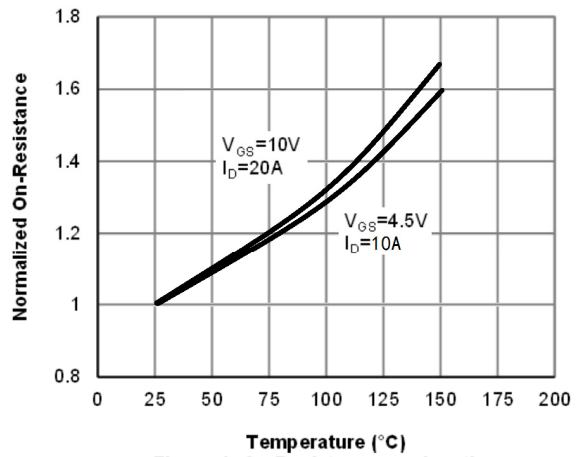

Figure 4: On-Resistance vs. Junction Temperature

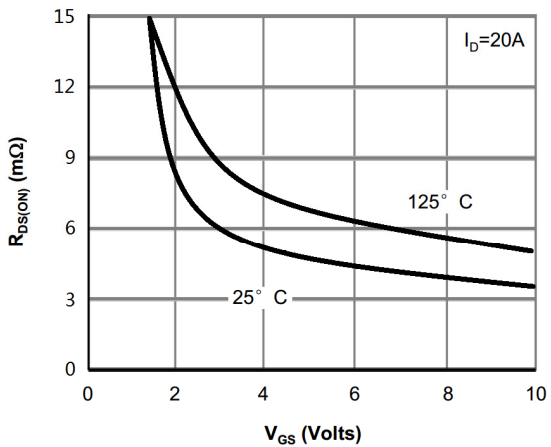

Figure 5: On-Resistance vs. Gate-Source Voltage

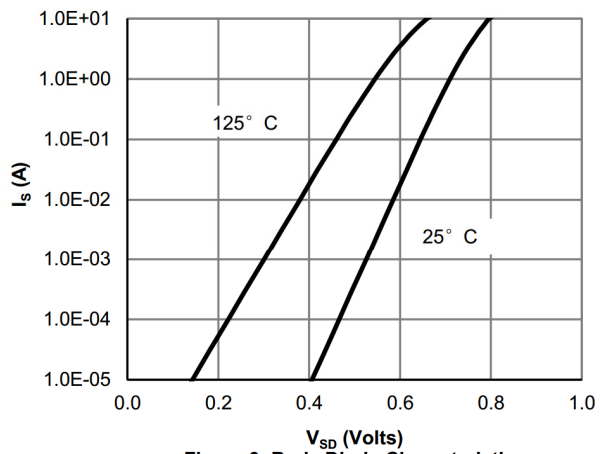

Figure 6: Body-Diode Characteristics

电参数曲线图 / Electrical Characteristic Curve

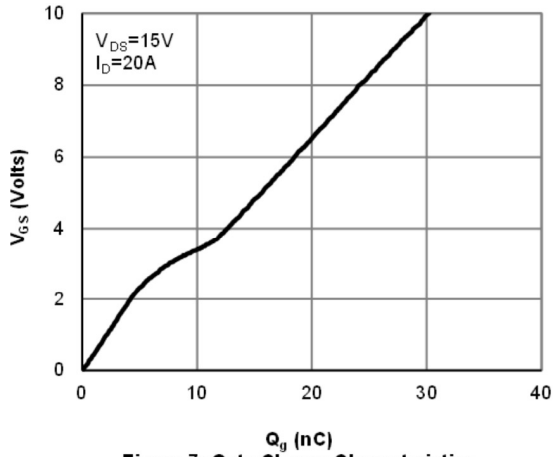

Figure 7: Gate-Charge Characteristics

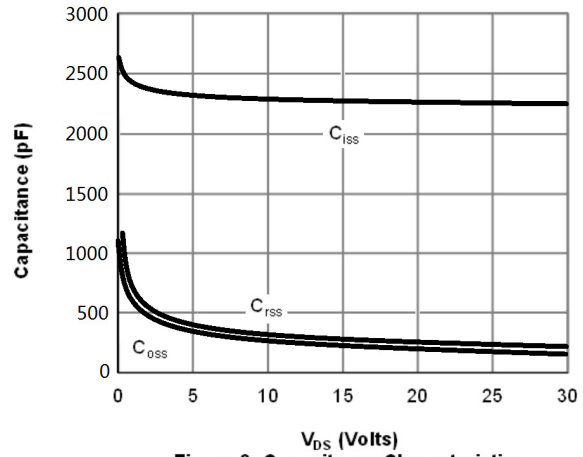

Figure 8: Capacitance Characteristics

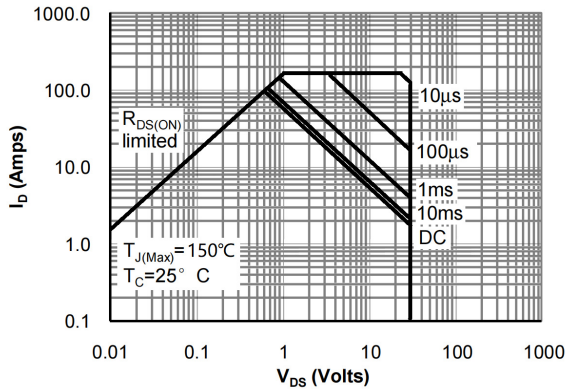

Figure 9: Maximum Forward Biased Safe Operating Area

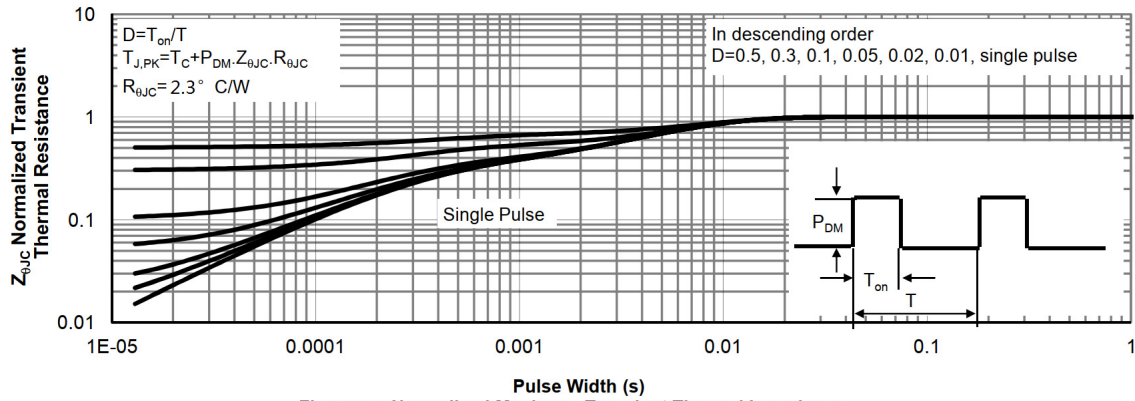
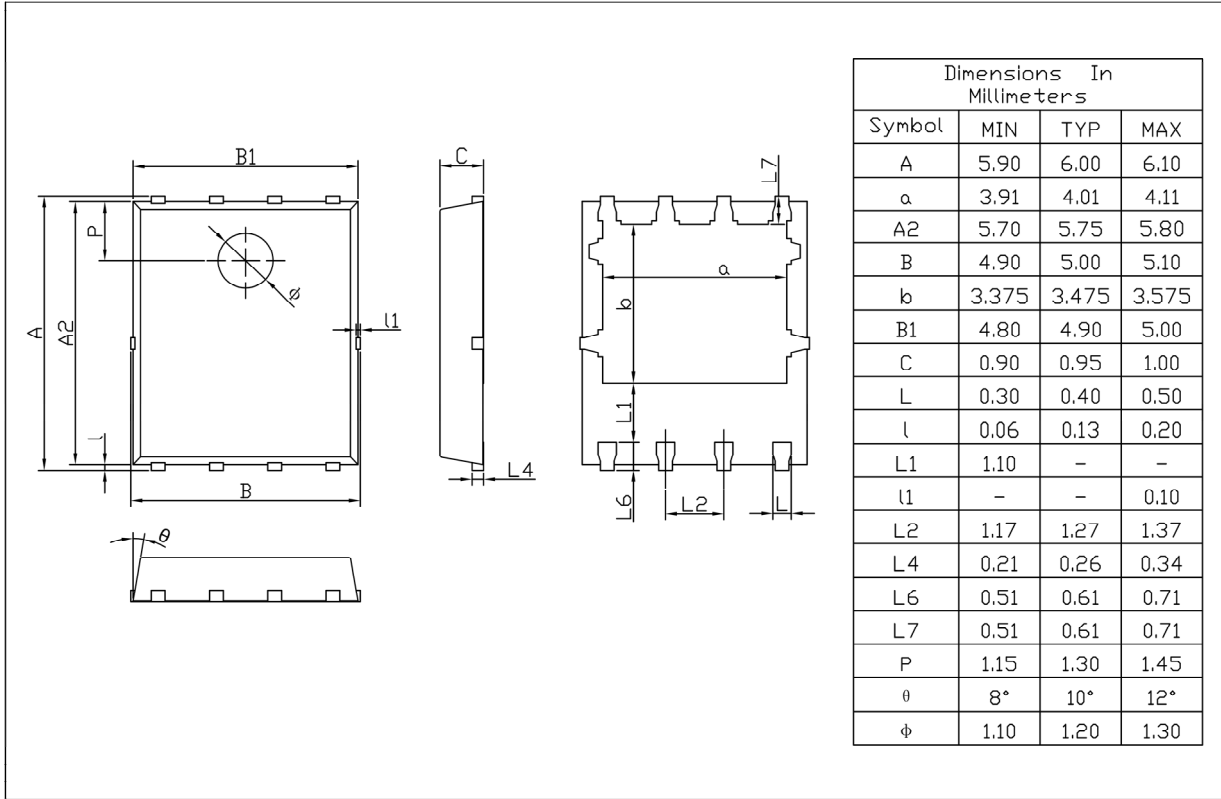

Figure 10: Normalized Maximum Transient Thermal Impedance

外形尺寸图 / Package Dimensions

PDFN5 × 6

Unit:mm



Rev.01 202209

印章说明 / Marking Instructions

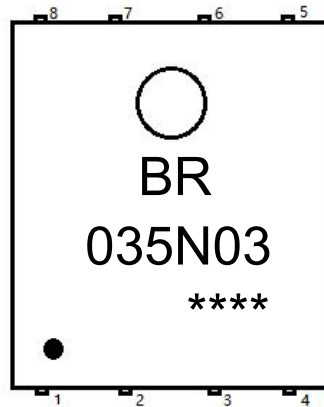

说明：

BR： 为公司代码

035N03： 为产品型号

****： 为生产批号代码，随生产批号变化

Note：

BR： Company Code

035N03： Product Type Code

****: Lot No. Code, code change with Lot No

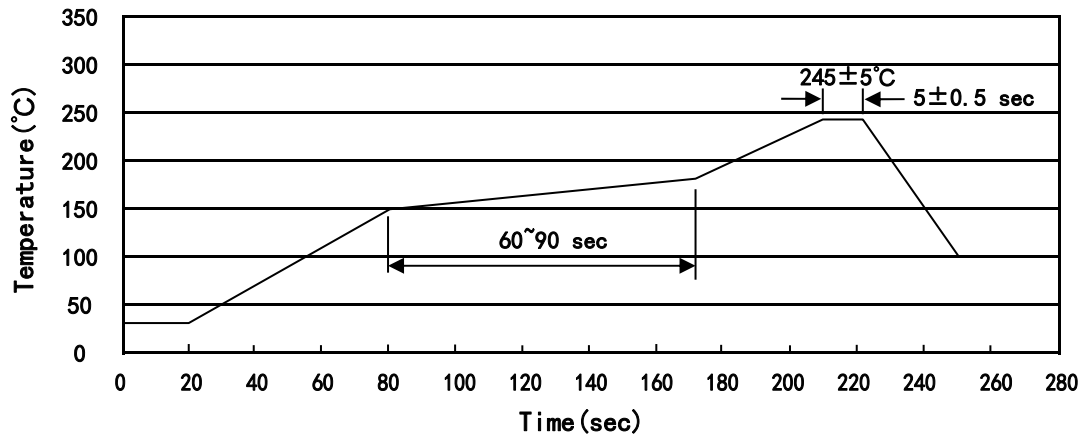
回流焊温度曲线图(无铅) / Temperature Profile for IR Reflow Soldering(Pb-Free)

说明：

- 1、预热温度 150~180°C，时间 60~90sec;
- 2、峰值温度 245±5°C，时间持续为 5±0.5sec;
- 3、焊接制程冷却速度为 2~10°C/sec.

Note:

- 1.Preheating:150~180°C, Time:60~90sec.
- 2.Peak Temp.:245±5°C, Duration:5±0.5sec.
3. Cooling Speed: 2~10°C/sec.

耐焊接热试验条件 / Resistance to Soldering Heat Test Conditions

温度：260±5°C

时间：10±1 sec.

Temp.:260±5°C

Time:10±1 sec

包装规格 / Packaging SPEC.

卷盘包装 / REEL

| Package Type 封装形式 | Units 包装数量 | | | | | Dimension 包装尺寸 (unit: mm ³) | | |
|----------------------|--------------------|-------------------------|------------------------|------------------------------|------------------------|---|-------------|-------------|
| | Units/Reel 只/卷盘 | Reels/Inner Box 卷盘/盒 | Units/Inner Box 只/盒 | Inner Boxes/Outer Box 盒/箱 | Units/Outer Box 只/箱 | Reel | Inner Box 盒 | Outer Box 箱 |
| PDFN5×6 | 5,000 | 2 | 10,000 | 6 | 60,000 | 13"×12 | 360×360×50 | 380×335×366 |

使用说明 / Notices