

1. DESCRIPTION

The XA2179-S13 is a GaAs MMIC L, S-band SPDT (Single Pole Double Throw) switch for mobile phone and other L, S-band applications. This device operates with dual control voltages of 2.5V to 5.3 V.

This device can operate from 0.05 to 3.0 GHz, with low insertion loss and high isolation.

This device is housed in a 6-pin SOT363 package, and is suitable for high-density surface mounting.

2. FEATURES

- Switch control voltage : $V_{cont}(H) = 2.5\text{ V to }5.3\text{ V (3.0 V TYP.)}$
: $V_{cont}(L) = -0.2\text{ V to }+0.2\text{ V (0 V TYP.)}$
- Low insertion loss : $Lins1 = 0.25\text{ dB TYP. @ }f = 0.05\text{ to }1.0\text{ GHz, }V_{cont}(H) = 3.0\text{ V, }V_{cont}(L) = 0\text{ V}$
: $Lins2 = 0.30\text{ dB TYP. @ }f = 1.0\text{ to }2.0\text{ GHz, }V_{cont}(H) = 3.0\text{ V, }V_{cont}(L) = 0\text{ V}$
: $Lins3 = 0.35\text{ dB TYP. @ }f = 2.0\text{ to }2.5\text{ GHz, }V_{cont}(H) = 3.0\text{ V, }V_{cont}(L) = 0\text{ V}$
: $Lins4 = 0.40\text{ dB TYP. @ }f = 2.5\text{ to }3.0\text{ GHz, }V_{cont}(H) = 3.0\text{ V, }V_{cont}(L) = 0\text{ V}$
- High isolation : $ISL1 = 27\text{ dB TYP. @ }f = 0.05\text{ to }2.0\text{ GHz, }V_{cont}(H) = 3.0\text{ V, }V_{cont}(L) = 0\text{ V}$
: $ISL2 = 24\text{ dB TYP. @ }f = 2.0\text{ to }3.0\text{ GHz, }V_{cont}(H) = 3.0\text{ V, }V_{cont}(L) = 0\text{ V}$
- Power handling : $Pin(0.1\text{ dB}) = +29.0\text{ dBm TYP. @ }f = 0.5\text{ to }3.0\text{ GHz, }V_{cont}(H) = 3.0\text{ V, }V_{cont}(L) = 0\text{ V}$
: $Pin(1\text{ dB}) = +32.0\text{ dBm TYP. @ }f = 0.5\text{ to }3.0\text{ GHz, }V_{cont}(H) = 3.0\text{ V, }V_{cont}(L) = 0\text{ V}$
- High-density surface mounting : 6-pin super minimold package (SOT363 , $2.0 \times 1.25 \times 0.9\text{ mm}$)

3. APPLICATIONS

L, S-band digital cellular or cordless telephone

PCS, W-LAN, WLL and Bluetooth™ etc.

4. PIN CONNECTIONS AND INTERNAL BLOCK DIAGRAM

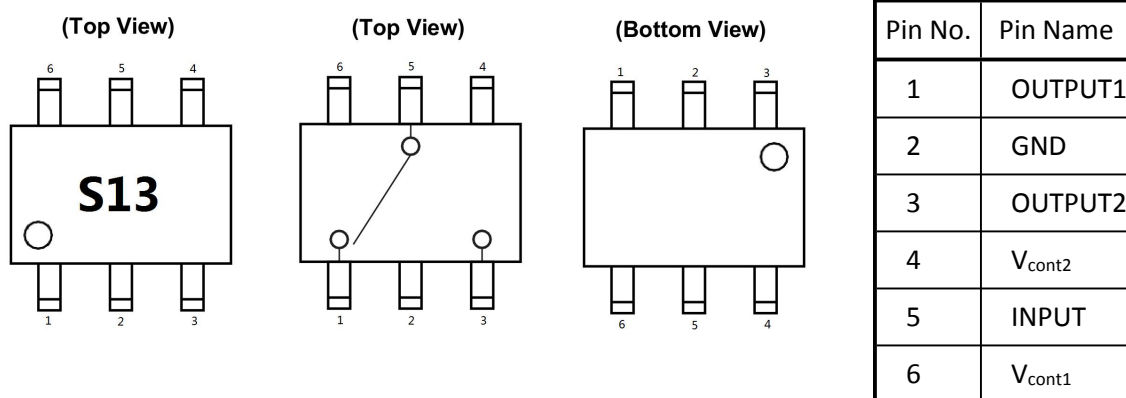

5. TRUTH TABLE

V _{cont1}	V _{cont2}	INPUT-OUTPUT1	INPUT-OUTPUT2
Low	High	ON	OFF
High	Low	OFF	ON

6. ABSOLUTE MAXIMUM RATINGS (T_A = +25°C, unless otherwise specified)

Parameter	Symbol	Ratings	Unit
Switch Control Voltage	V _{cont}	6.0 ^{Note}	V
Input Power	P _{in}	+33	dBm
Operating Ambient Temperature	T _A	-45 to +85	°C
Storage Temperature	T _{stg}	-55 to +150	°C

Note |V_{cont1} - V_{cont2}| ≤ 6.0 V

7. RECOMMENDED OPERATING RANGE (T_A = +25°C, unless otherwise specified)

Parameter	Symbol	MIN.	TYP.	MAX.	Unit
Switch Control Voltage (H)	V _{cont (H)}	2.5	3.0	5.3	V
Switch Control Voltage (L)	V _{cont (L)}	-0.2	0	0.2	V

8. ELECTRICAL CHARACTERISTICS

(T_A = +25°C, V_{cont (H)} = 3.0 V, V_{cont (L)} = 0 V, DC blocking capacitors = 100 pF, unless otherwise specified)

Parameter	Symbol	Test Conditions	MIN.	TYP.	MAX.	Unit
Insertion Loss 1	L _{ins1}	f = 0.05 to 1.0 GHz Note1	—	0.25	0.45	dB
Insertion Loss 2	L _{ins2}	f = 1.0 to 2.0 GHz	—	0.30	0.50	dB
Insertion Loss 3	L _{ins3}	f = 2.0 to 2.5 GHz	—	0.35	0.55	dB
Insertion Loss 4	L _{ins4}	f = 2.5 to 3.0 GHz	—	0.40	0.60	dB
Isolation 1	ISL1	f = 0.05 to 2.0 GHz Note1	23	27	—	dB

Isolation 2	ISL2	f = 2.0 to 3.0 GHz	20	24	—	dB
Input Return Loss	RL _{in}	f = 0.05 to 3.0 GHz Note1	15	20	—	dB
Output Return Loss	RL _{out}	f = 0.05 to 3.0 GHz Note1	15	20	—	dB
0.1 dB Loss Compression Input Power Note2	P _{in (0.1 dB)}	f = 2.0 GHz	+25.5	+29.0	—	dBm
		f = 2.5 GHz	+25.5	+29.0	—	dBm
		f = 0.5 to 3.0 GHz	—	+29.0	—	dBm
Switch Control Current	I _{cont}	No signal	—	4	20	μA
Switch Control Speed	t _{sw}	50%CTL to 90/10%RF	—	50	500	ns

Note1. DC blocking capacitor = 1000 pF at f = 0.05 to 0.5 GHz.

2. P_{in (0.1 dB)} is the measured input power level when the insertion loss increases 0.1 dB more than that of linear range.

9. STANDARD CHARACTERISTICS FOR REFERENCE

(T A = +25 °C, V_{cont (H)} = 3.0 V, V_{cont (L)} = 0 V, DC blocking capacitors = 100 pF, unless otherwise specified)

Parameter	Symbol	Test Conditions	MIN.	TYP.	MAX.	Unit
1 dB Loss Compression Input Power Note	P _{in (1 dB)}	f = 0.5 to 3.0 GHz	—	+32.0	—	dBm
3rd Order Intermodulation Intercept Point	IIP3	f = 0.5 to 3.0 GHz, 2 tone, 5 MHz spacing	—	+60.0	—	dBm

Note P in (1 dB) is the measured input power level when the insertion loss increases 1 dB more than that of linear range.

Caution When using this IC, a DC coupling capacitor must be externally attached to the I/O pins.

A DC coupling capacitor with a capacitance of 100 pF or lower is recommended when using a frequency of 0.5 GHz or higher, and one with a capacitance of 1,000 pF is recommended when using a frequency of less than 0.5 GHz. The ideal value changes depending on the frequency and bandwidth used, so select a capacitor with a suitable capacitance according to the usage conditions.

10. APPLICATION CIRCUIT

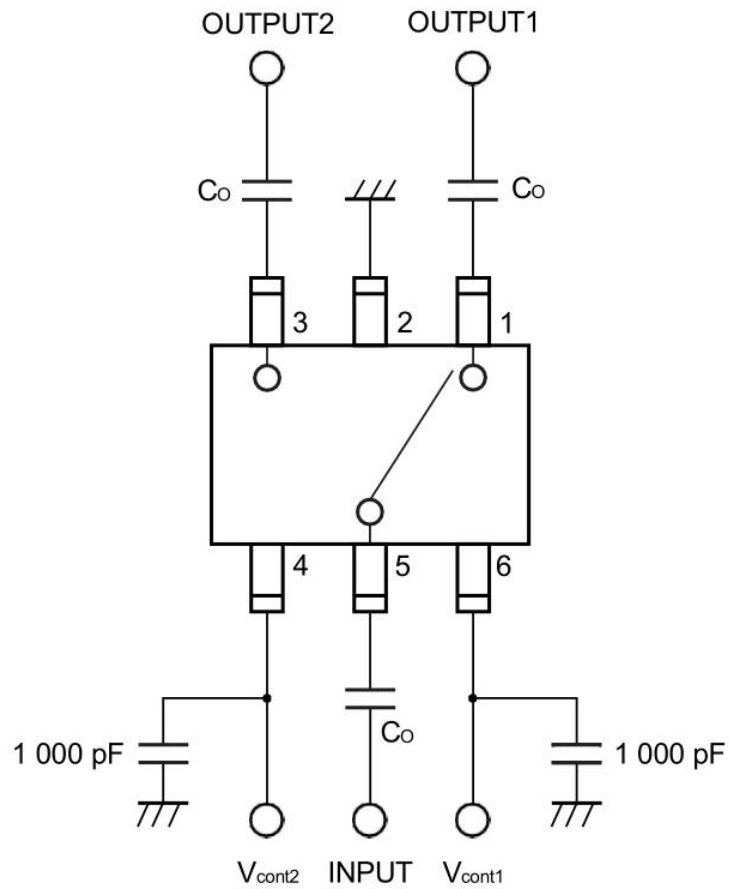

Remark CO : 0.05 to 0.5 GHz 1000 pF
0.5 to 3.0 GHz 100 pF

The application circuits and their parameters are for reference only and are not intended for use in actual design-ins.

11. ILLUSTRATION OF THE TEST CIRCUIT ASSEMBLED ON EVALUATION BOARD

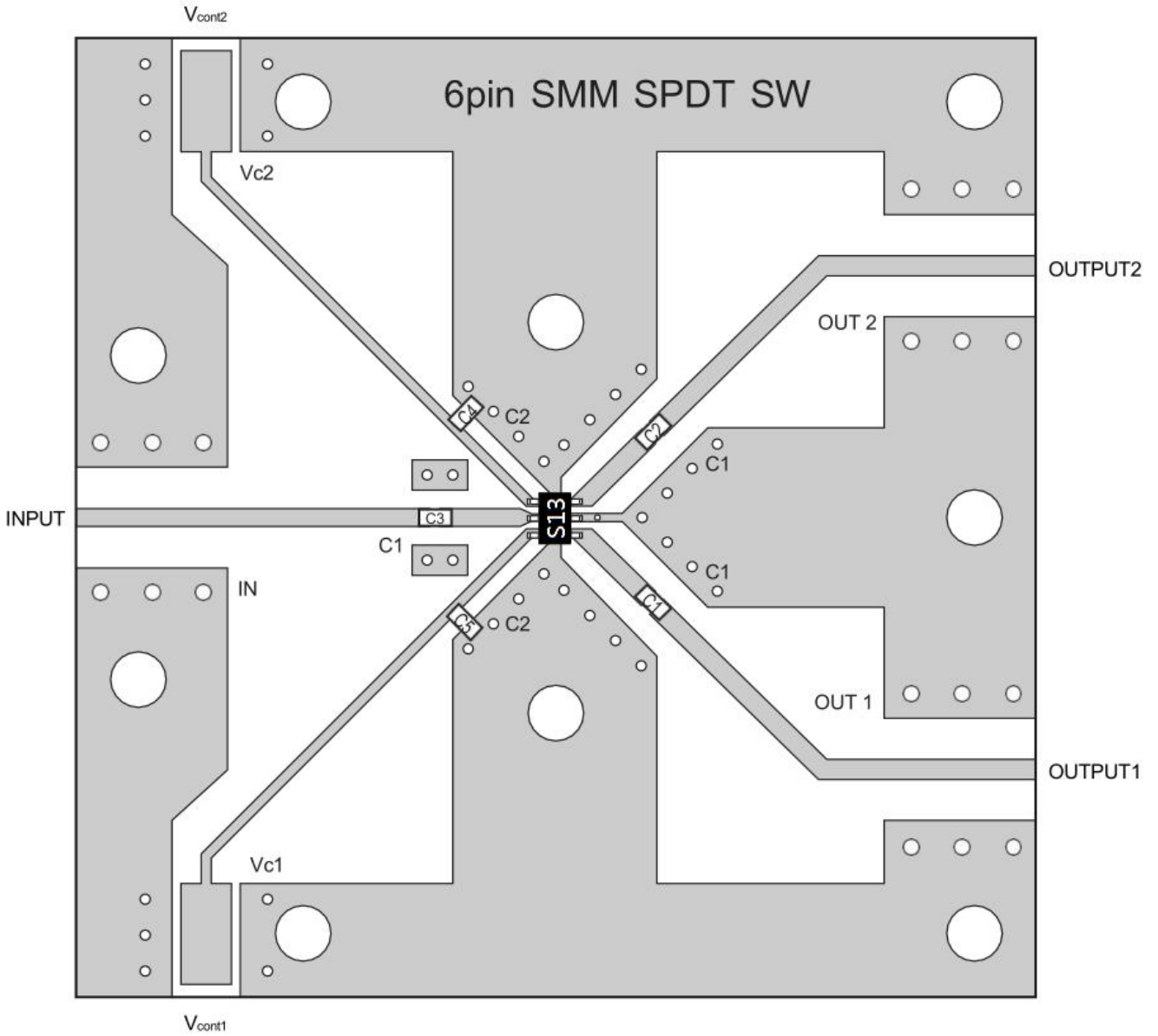

12. USING THE NEC EVALUATION BOARD

Symbol	Values
C1, C2, C3	100 pF
C4, C5	1000 pF

13. TYPICAL CHARACTERISTICS

($T_A = +25^\circ\text{C}$, $V_{\text{cont}}(\text{H}) = 3.0\text{ V}$, $V_{\text{cont}}(\text{L}) = 0\text{ V}$, DC blocking capacitors = 100 pF, unless otherwise specified)

INPUT-OUTPUT1
INSERTION LOSS vs. FREQUENCY

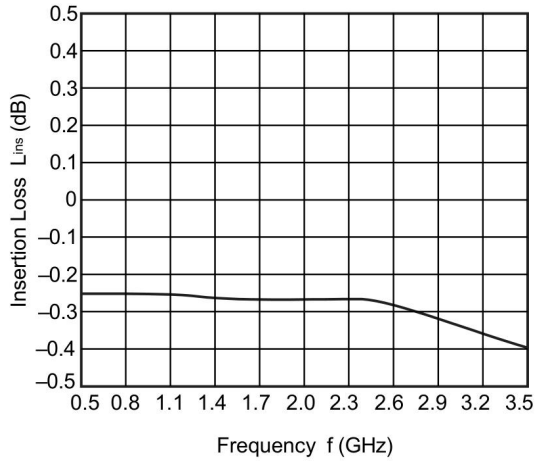

INPUT-OUTPUT2
INSERTION LOSS vs. FREQUENCY

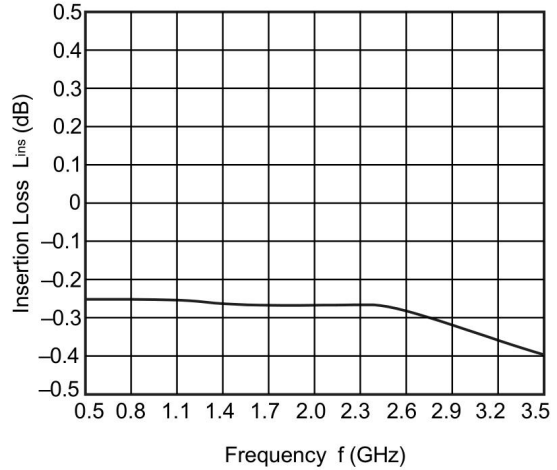

INPUT-OUTPUT1
ISOLATION vs. FREQUENCY

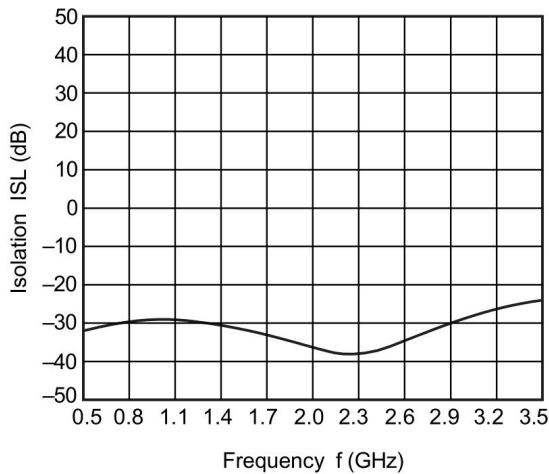

INPUT-OUTPUT2
ISOLATION vs. FREQUENCY

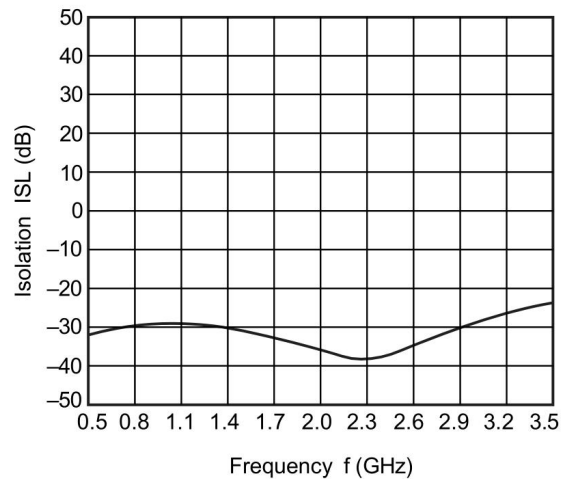

INPUT-OUTPUT1
INPUT RETURN LOSS vs. FREQUENCY

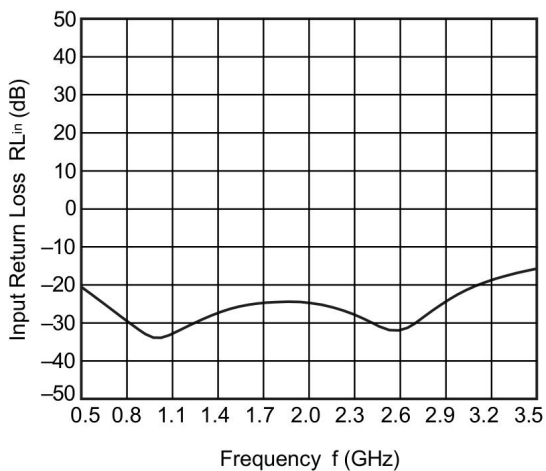

INPUT-OUTPUT2
INPUT RETURN LOSS vs. FREQUENCY

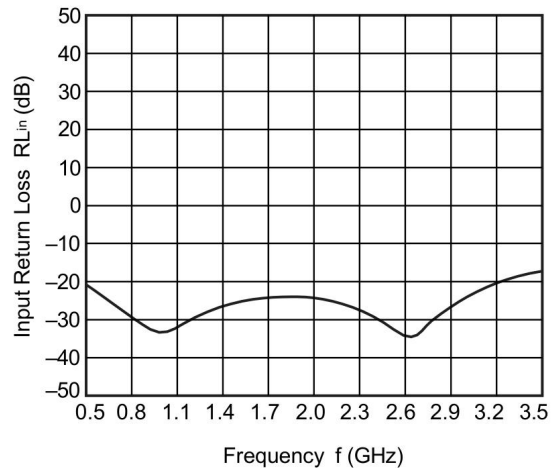

INPUT-OUTPUT1
OUTPUT RETURN LOSS vs. FREQUENCY

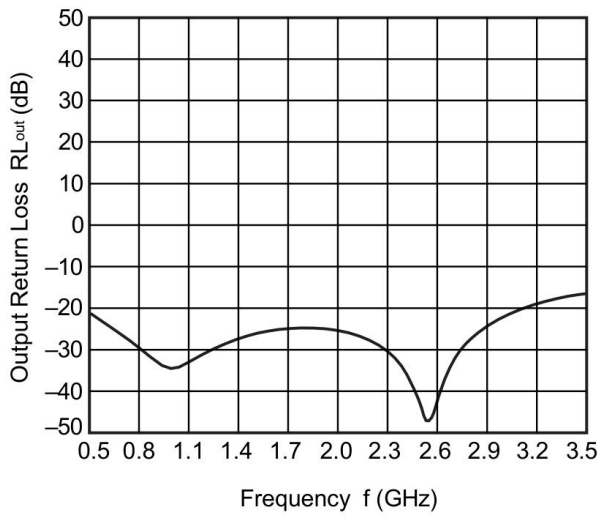

INPUT-OUTPUT2
OUTPUT RETURN LOSS vs. FREQUENCY

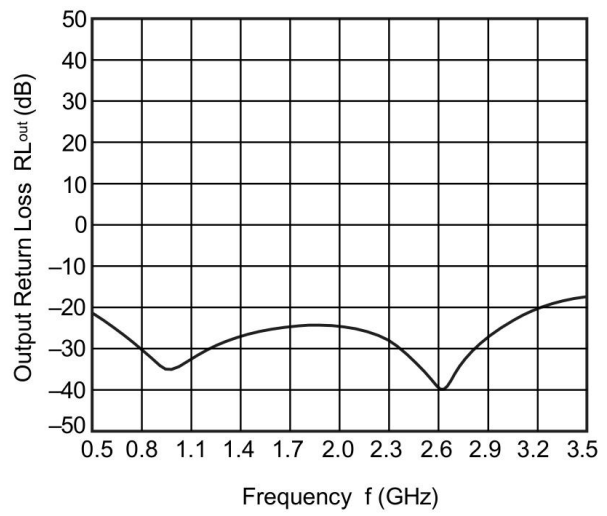

OUTPUT POWER vs. INPUT POWER

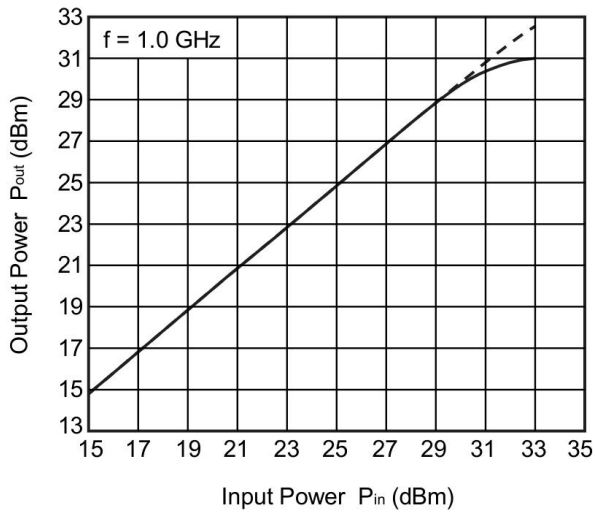

OUTPUT POWER vs. INPUT POWER

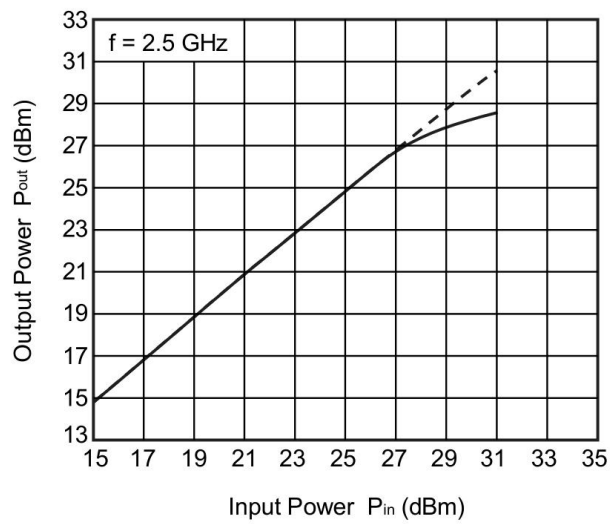

14. ORDERING INFORMATION

Ordering Information

Part Number	Device Marking	Package Type	Body size (mm)	Temperature (°C)	MSL	Transport Media	Package Quantity
XA2179-S13	S13	SOT363	2.10 * 1.22	- 40 to 85	MSL3	T&R	3000

15. DIMENSIONAL DRAWINGS

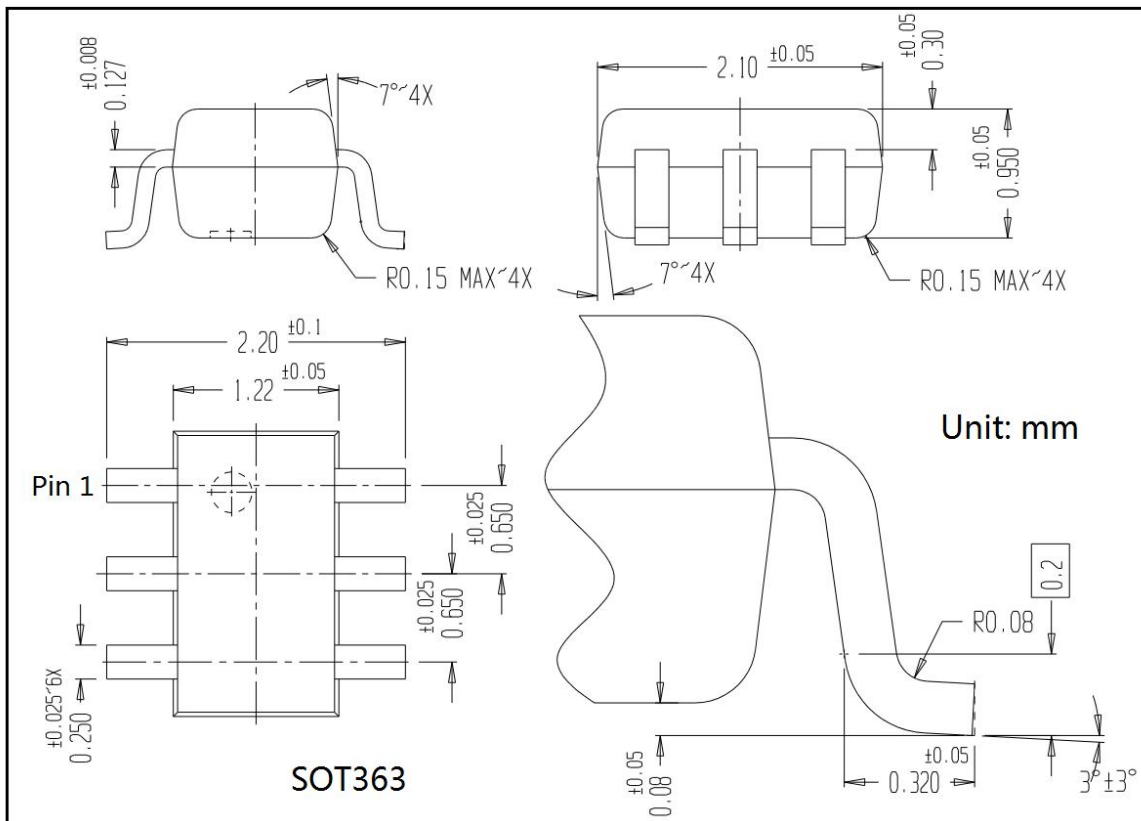

[if you need help contact us. Xinluda reserves the right to change the above information without prior notice]