

FEATURES

- Fast switching
- 100% avalanche tested
- Improved dv/dt capability

APPLICATIONS

- Switch Mode Power Supply (SMPS)
- Uninterruptible Power Supply (UPS)
- Power Factor Correction (PFC)

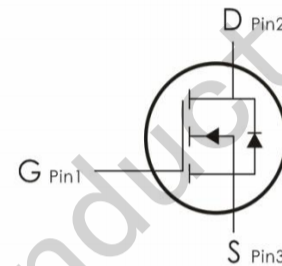
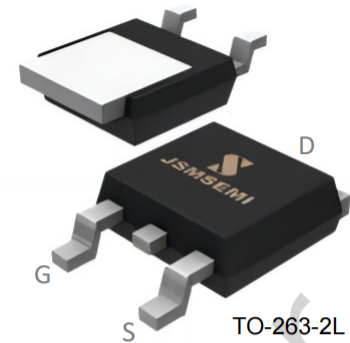

| Device Marking and Package Information | | |
|--|---------|-----------|
| Device | Package | Marking |
| NTB5605PT4G | TO-263 | NTB5605PG |

| Absolute Maximum Ratings $T_C = 25^\circ\text{C}$, unless otherwise noted | | | |
|--|----------------|----------|------------------|
| Parameter | Symbol | Value | Unit |
| | | TO-263 | |
| Drain-Source Voltage ($V_{GS} = 0\text{V}$) | V_{DSS} | -60 | V |
| Continuous Drain Current | I_D | -35 | A |
| Pulsed Drain Current (note1) | I_{DM} | -140 | A |
| Gate-Source Voltage | V_{GSS} | ± 20 | V |
| Single Pulse Avalanche Energy (note2) | E_{AS} | 250 | mJ |
| Avalanche Current (note1) | I_{AR} | -50 | A |
| Repetitive Avalanche Energy (note1) | E_{AR} | 36 | mJ |
| Power Dissipation ($T_C = 25^\circ\text{C}$) | P_D | 110 | W |
| Operating Junction and Storage Temperature Range | T_J, T_{stg} | -55~+150 | $^\circ\text{C}$ |

| Thermal Resistance | | | |
|---|------------|--------|------|
| Parameter | Symbol | Value | Unit |
| | | TO-263 | |
| Thermal Resistance, Junction-to-Case | R_{thJC} | 1.14 | KW |
| Thermal Resistance, Junction-to-Ambient | R_{thJA} | 60 | |

| Specifications $T_J = 25^\circ\text{C}$, unless otherwise noted | | | | | | |
|--|---------------|--|-------|------|-----------|------------|
| Parameter | Symbol | Test Conditions | Value | | | Unit |
| | | | Min. | Typ. | Max. | |
| Static | | | | | | |
| Drain-Source Breakdown Voltage | $V_{(BR)DSS}$ | $V_{GS} = 0V, I_D = 250\mu A$ | -60 | -- | -- | V |
| Zero Gate Voltage Drain Current | I_{DSS} | $V_{DS} = 60V, V_{GS} = 0V, T_J = 25^\circ\text{C}$ | -- | -- | 1 | μA |
| | | $V_{DS} = 48V, V_{GS} = 0V, T_J = 125^\circ\text{C}$ | -- | -- | 100 | |
| Gate-Source Leakage | I_{GSS} | $V_{GS} = \pm 20V$ | -- | -- | ± 100 | nA |
| Gate-Source Threshold Voltage | $V_{GS(th)}$ | $V_{DS} = V_{GS}, I_D = 250\mu A$ | -2.0 | -- | -4.0 | V |
| Drain-Source On-Resistance (Note3) | $R_{DS(on)}$ | $V_{GS} = 10V, I_D = 17.5A$ | -- | 40 | 55 | m Ω |
| Dynamic | | | | | | |
| Input Capacitance | C_{iss} | $V_{GS} = 0V,$ $V_{DS} = 30V,$ $f = 1.0\text{MHz}$ | -- | 1489 | -- | μF |
| Output Capacitance | C_{oss} | | -- | 280 | -- | |
| Reverse Transfer Capacitance | C_{rss} | | -- | 80 | -- | |
| Total Gate Charge | Q_g | $V_{DD} = 30V, I_D = 35A,$ $V_{GS} = 10V$ | -- | 40 | -- | nC |
| Gate-Source Charge | Q_{gs} | | -- | 6 | -- | |
| Gate-Drain Charge | Q_{gd} | | -- | 20 | -- | |
| Turn-on Delay Time | $t_{d(on)}$ | $V_{DD} = 30V, I_D = 15A,$ $R_G = 6\ \Omega$ | -- | 15 | -- | ns |
| Turn-on Rise Time | t_r | | -- | 30 | -- | |
| Turn-off Delay Time | $t_{d(off)}$ | | -- | 40 | -- | |
| Turn-off Fall Time | t_f | | -- | 20 | -- | |
| Drain-Source Body Diode Characteristics | | | | | | |
| Continuous Body Diode Current | I_S | $T_C = 25^\circ\text{C}$ | -- | -- | -35 | A |
| Pulsed Diode Forward Current | I_{SM} | | -- | -- | -140 | |
| Body Diode Voltage | V_{SD} | $T_J = 25^\circ\text{C}, I_{SD} = 25A, V_{GS} = 0V$ | -- | -- | -2 | V |
| Reverse Recovery Time | t_{rr} | $V_{GS} = 0V, I_S = 50A,$ $di_F/dt = 100A/\mu s$ | -- | 68 | -- | ns |
| Reverse Recovery Charge | Q_{rr} | | -- | 4.2 | -- | μC |

Notes

1. Repetitive Rating: Pulse width limited by maximum junction temperature
2. $L=1\text{mH}, V_{DD} = 50V, R_G = 25\ \Omega$, Starting $T_J = 25^\circ\text{C}$
3. Pulse Test: Pulse width $\leq 300\mu s$, Duty Cycle $\leq 1\%$

Typical Characteristics $T_J = 25^\circ\text{C}$, unless otherwise noted

Figure 1. Output Characteristics ($T_J = 25^\circ\text{C}$)

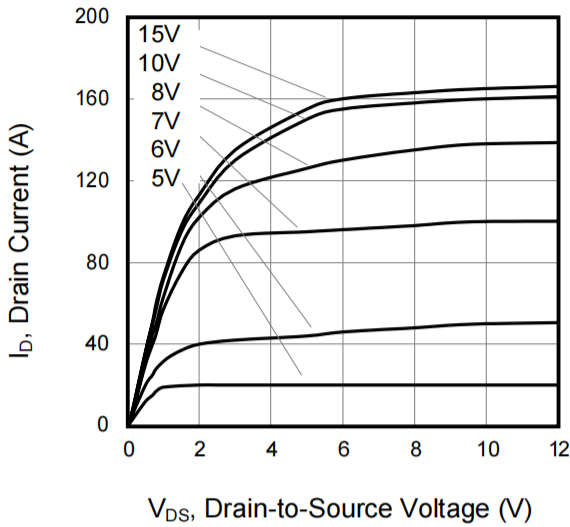

Figure 2. Body Diode Forward Voltage

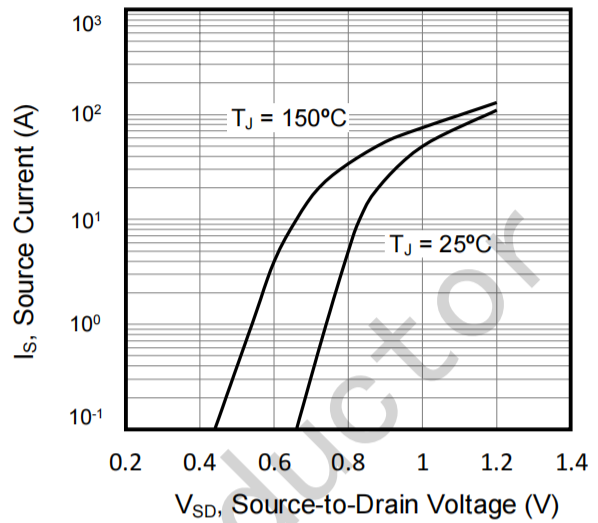

Figure 3. Drain Current vs. Temperature

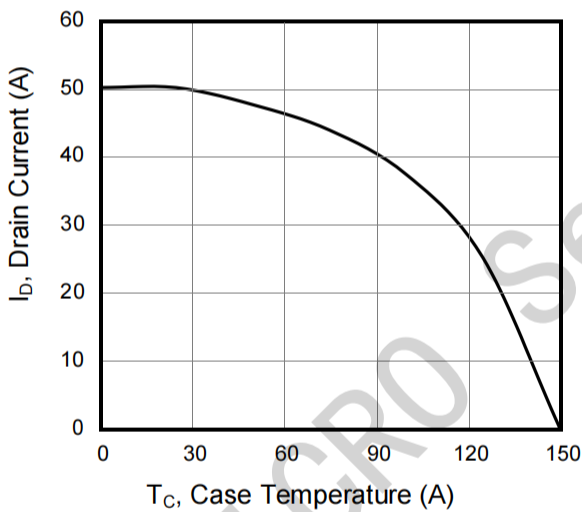

Figure 4. BV_{DSS} Variation vs. Temperature

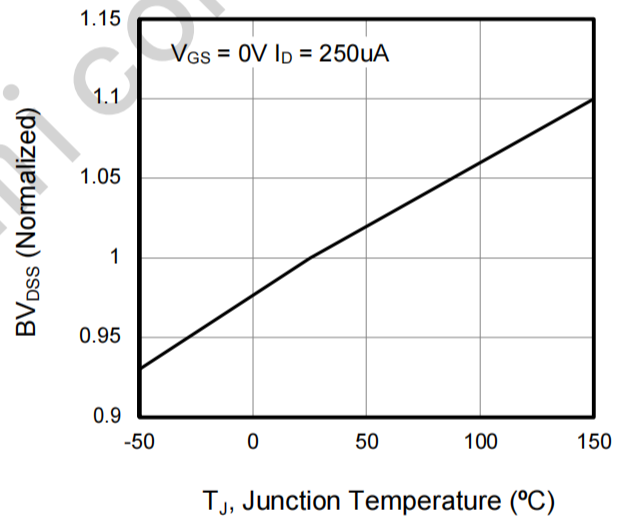

Figure 5. Transfer Characteristics

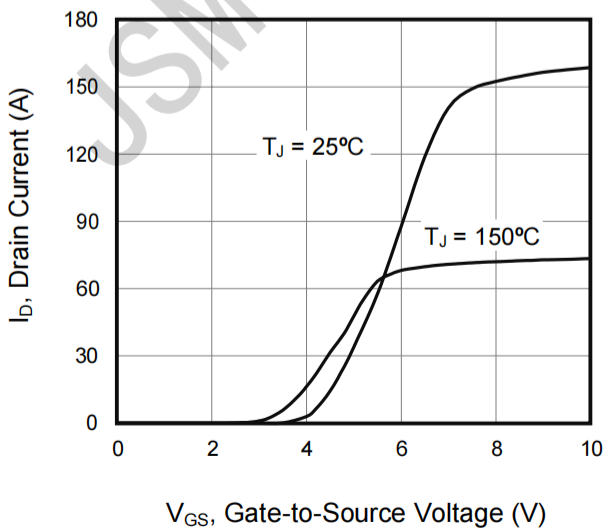
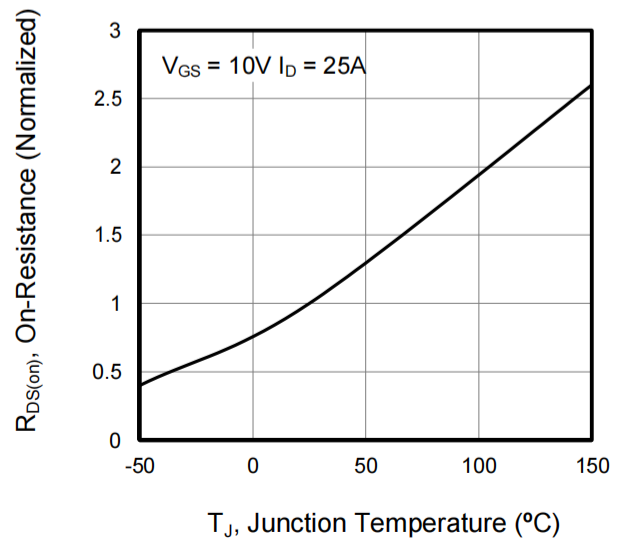

Figure 6. On-Resistance vs. Temperature



Typical Characteristics $T_J = 25\text{ C}$, unless otherwise noted

Figure 7. Capacitance

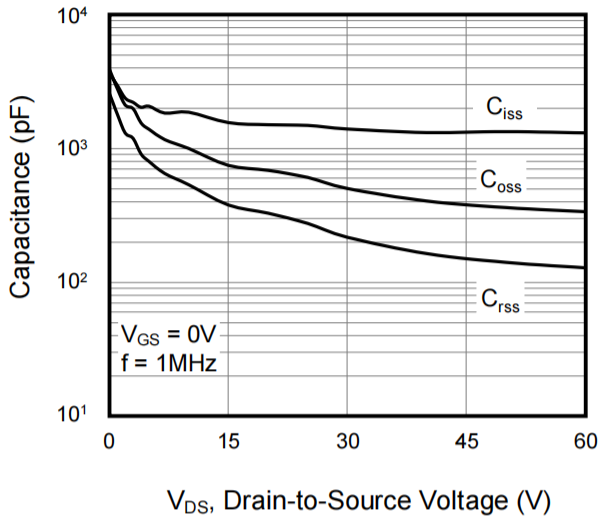

Figure 8. Gate Charge

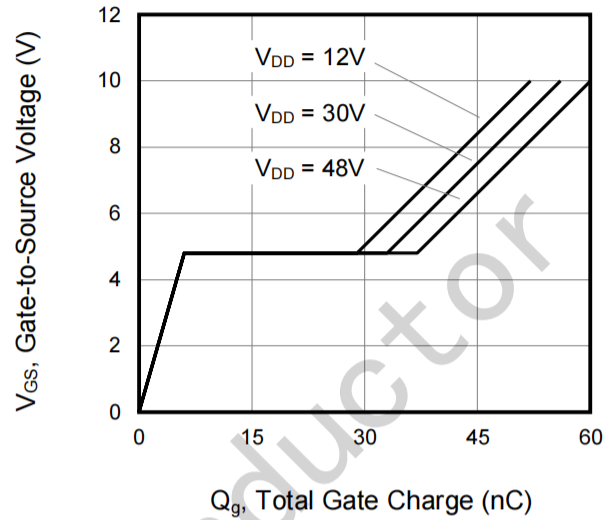

Figure 9. Transient Thermal Impedance
TO-263

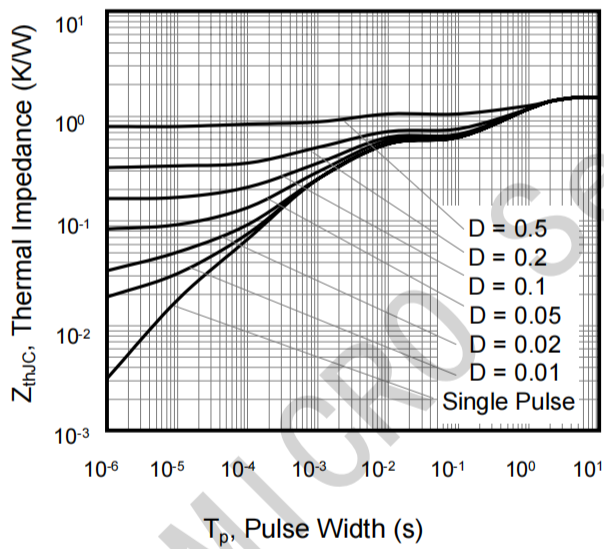

Figure A: Gate Charge Test Circuit and Waveform

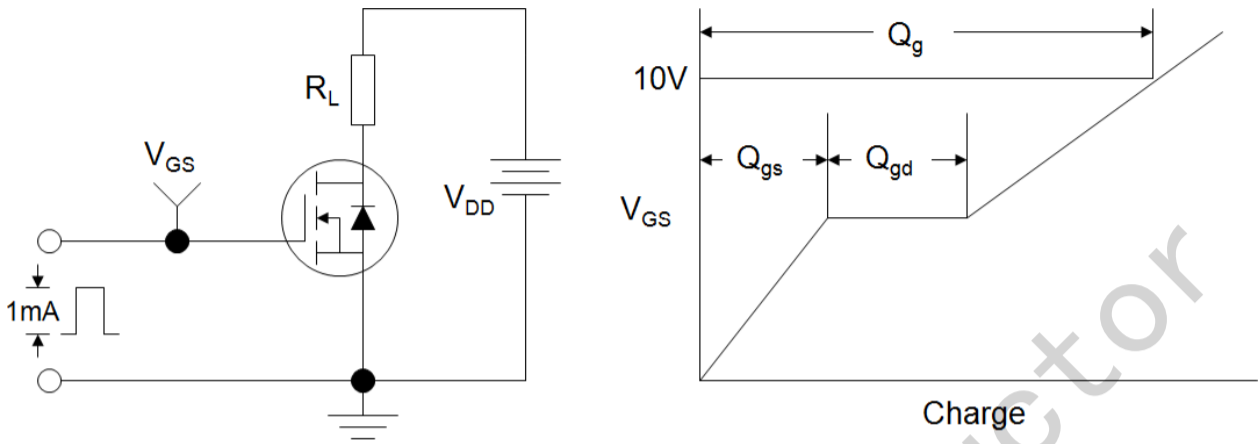

Figure B: Resistive Switching Test Circuit and Waveform

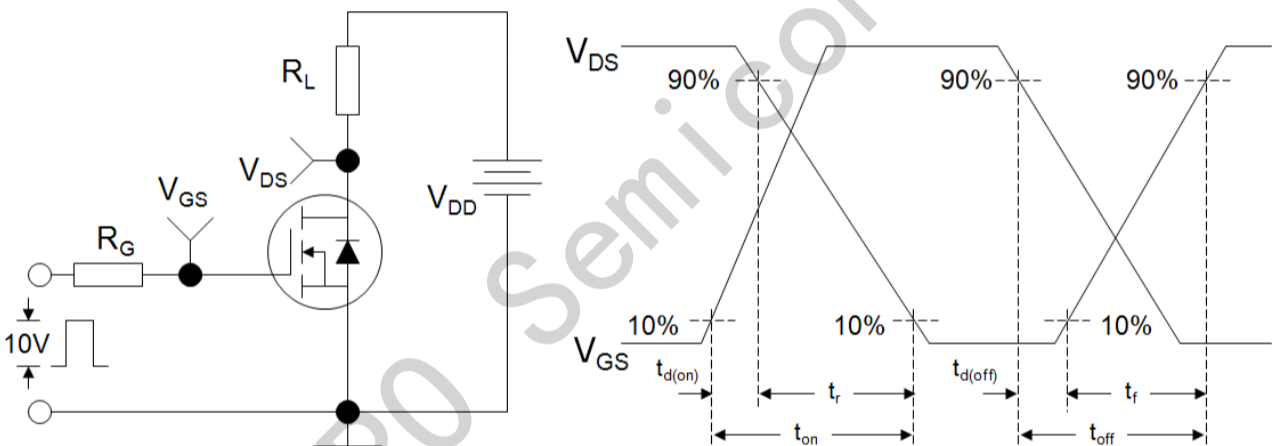
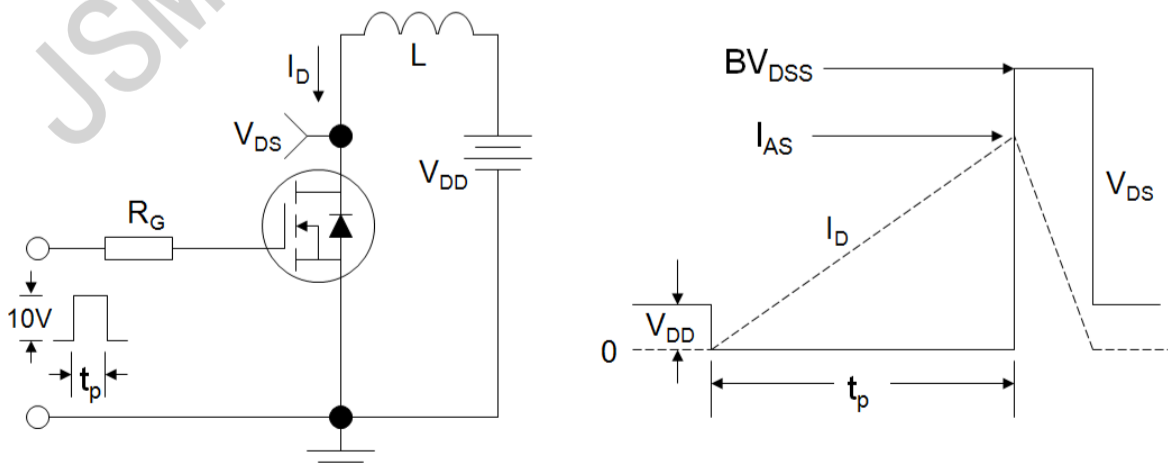
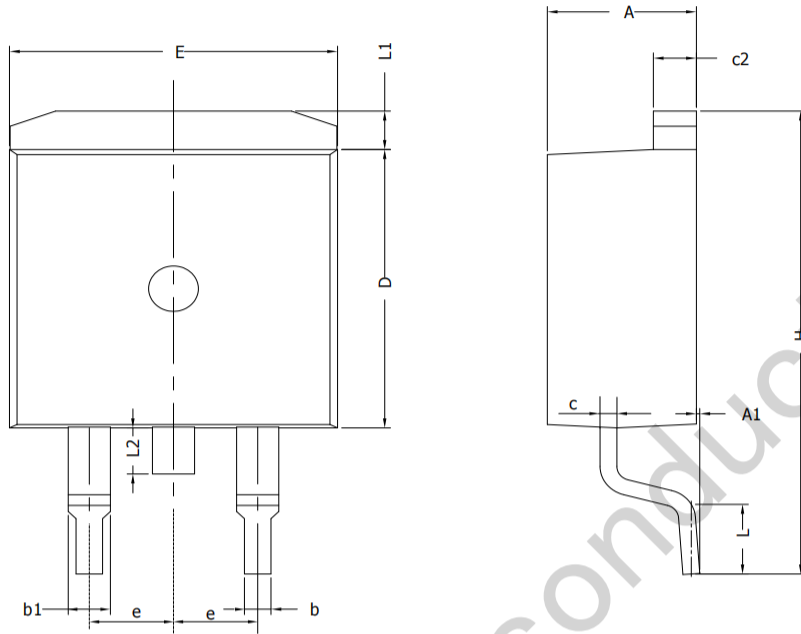

Figure C: Unclamped Inductive Switching Test Circuit and Waveform



Package Outline: TO-263



| SYMBOL | MIN | NOM | MAX |
|--------|---------|------|-------|
| A | 4.30 | 4.57 | 4.72 |
| A1 | 0 | 0.10 | 0.25 |
| b | 0.71 | 0.81 | 0.91 |
| c | 0.30 | --- | 0.60 |
| c2 | 1.17 | 1.27 | 1.37 |
| D | 8.50 | --- | 9.35 |
| E | 9.80 | --- | 10.45 |
| e | 2.54BSC | | |
| H | 14.70 | --- | 15.75 |
| L | 2.00 | 2.30 | 2.74 |
| L1 | 1.12 | 1.27 | 1.42 |
| L2 | --- | --- | 1.75 |