

2SK3391

Silicon N-Channel MOS FET UHF Power Amplifier

REJ03G0209-0200Z
(Previous ADE-208-847 (Z))
Rev.2.00
Apr.14.2004

Features

- High power output, High gain, High efficiency
PG = 18 dB, Pout = 1.6 W, $\eta_{add} = 58\%$ min. (f = 836 MHz)
- Compact package capable of surface mounting

Outline

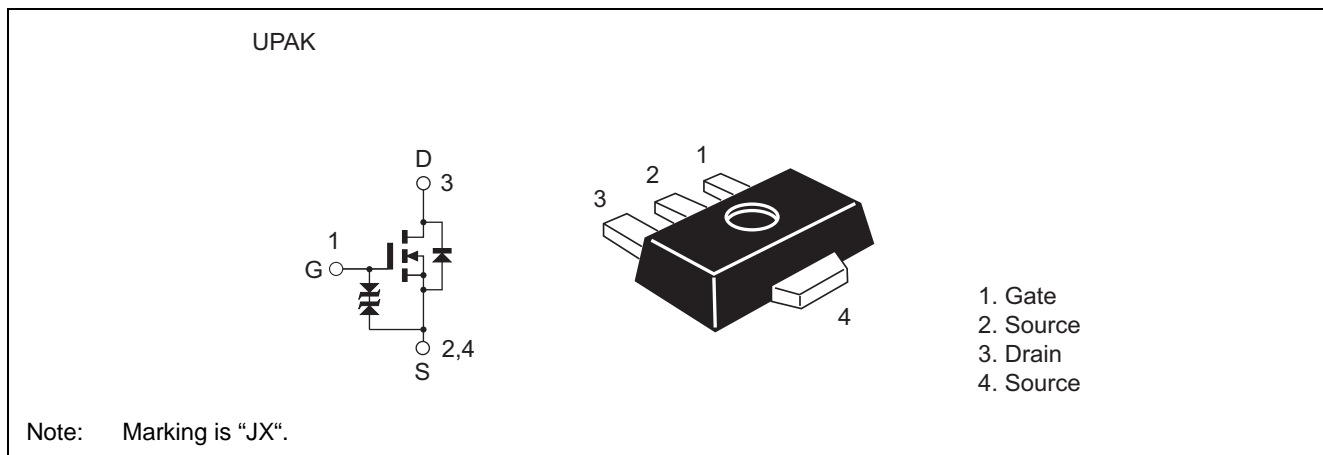

This Device is sensitive to Electro Static Discharge. An Adequate handling procedure is requested.

Absolute Maximum Ratings

(Ta = 25°C)

Item	Symbol	Ratings	Unit
Drain to source voltage	V_{DSS}	17	V
Gate to source voltage	V_{GSS}	± 10	V
Drain current	I_D	0.3	A
Drain peak current	$I_{D(pulse)}$ ^{Note1}	0.75	A
Channel dissipation	Pch ^{Note2}	5	W
Channel temperature	Tch	150	°C
Storage temperature	Tstg	-45 to +150	°C

Notes: 1. PW < 1sec, Tch < 150°C
2. Value at Tc = 25°C

Electrical Characteristics

(Ta = 25°C)

Item	Symbol	Min	Typ	Max	Unit	Test Conditions
Zero gate voltage drain current	I_{DSS}	—	—	10	μA	$V_{DS} = 13.7 V, V_{GS} = 0$
Gate to source leak current	I_{GSS}	—	—	± 5	μA	$V_{GS} = \pm 10 V, V_{DS} = 0$
Gate to source cutoff voltage	$V_{GS(off)}$	2.3	—	3.1	V	$I_D = 1 mA, V_{DS} = 13.7 V$
Input capacitance	C_{iss}	—	10	—	pF	$V_{GS} = 5 V, V_{DS} = 0, f = 1 MHz$
Output capacitance	C_{oss}	—	3.5	—	pF	$V_{DS} = 13.7 V, V_{GS} = 0, f = 1 MHz$
Output Power	P_{out}	1.6	—	—	W	$V_{DS} = 13.7 V, I_{D0} = 0.15 A$ $f = 836 MHz, P_{in} = 25.1 mW$
Added Efficiency	η_{add}	58	—	—	%	$V_{DS} = 13.7 V, I_{D0} = 0.15 A$ $f = 836 MHz, P_{in} = 25.1 mW$

Main Characteristics

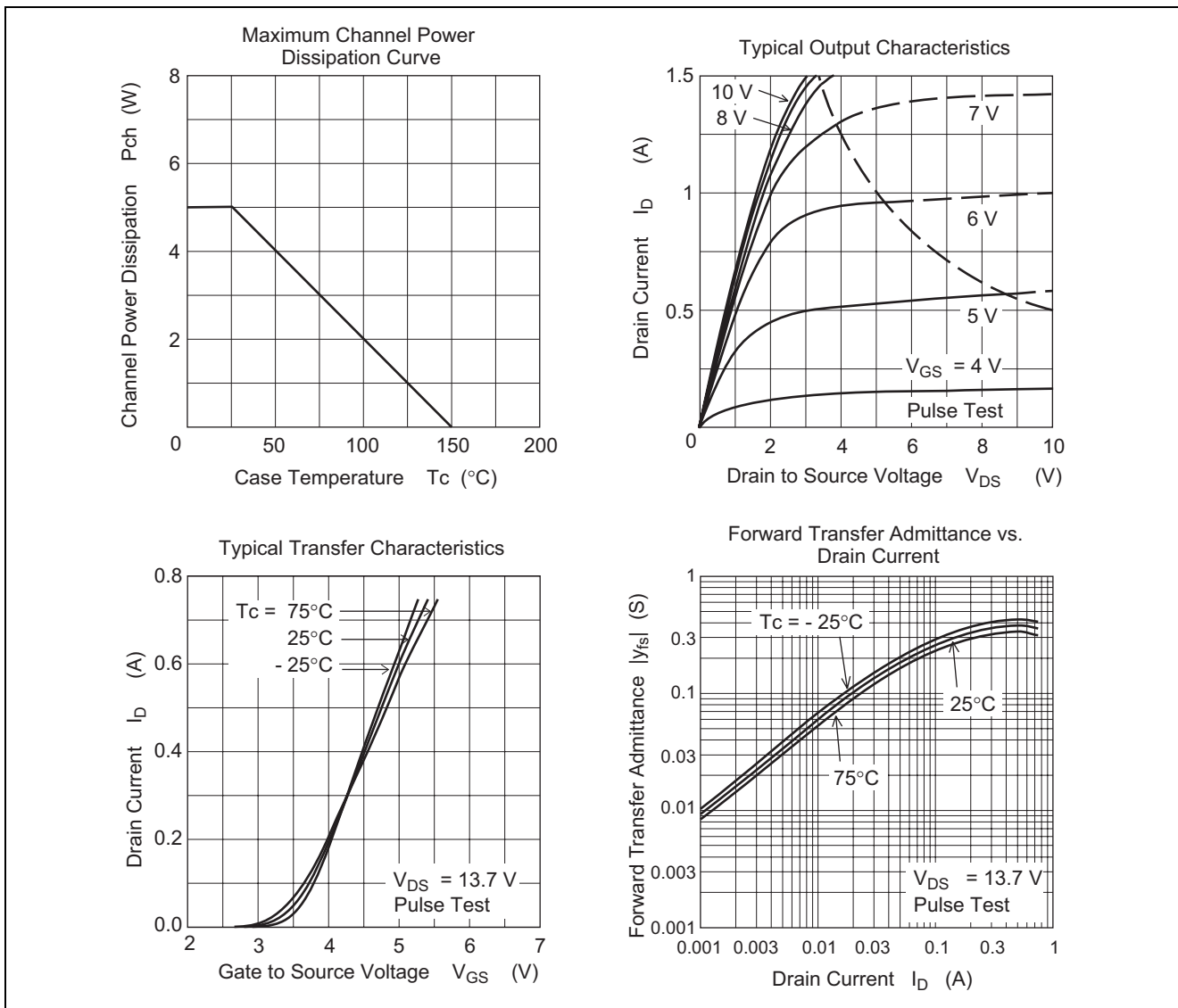

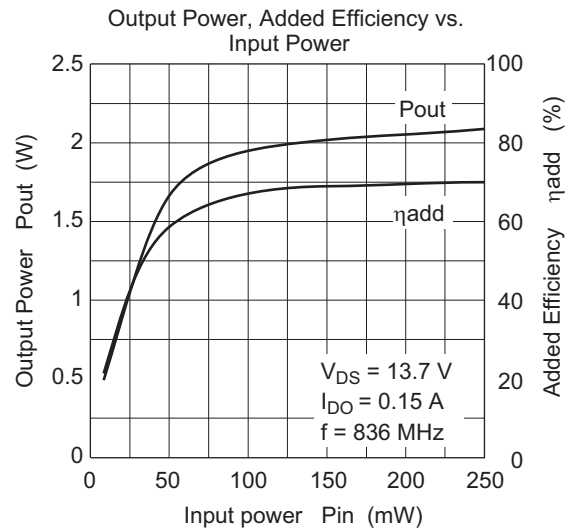
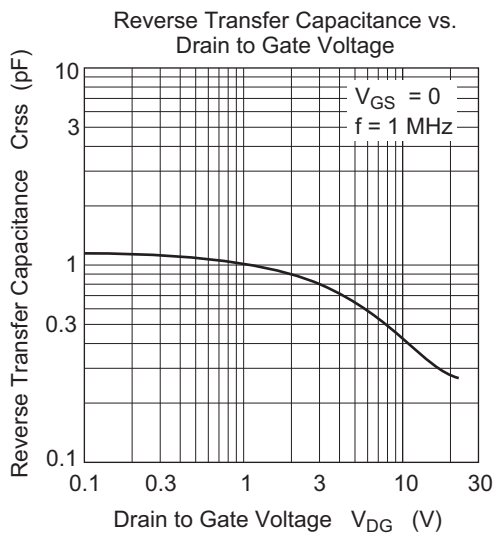
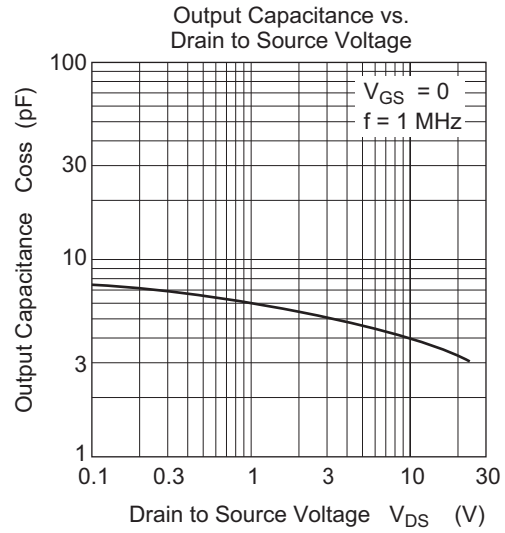
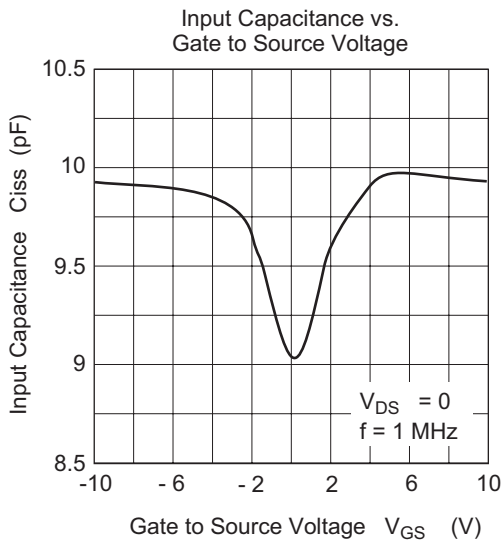
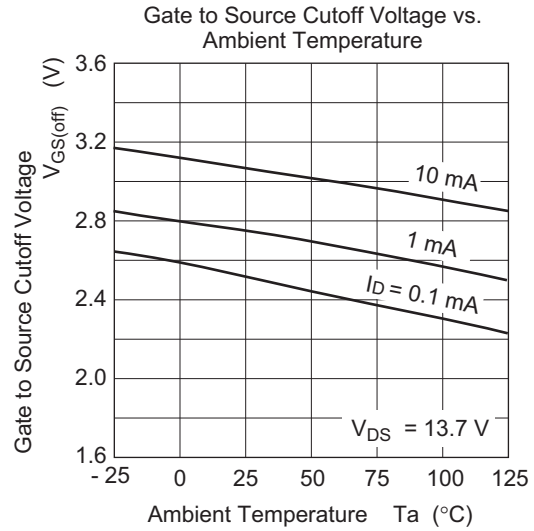
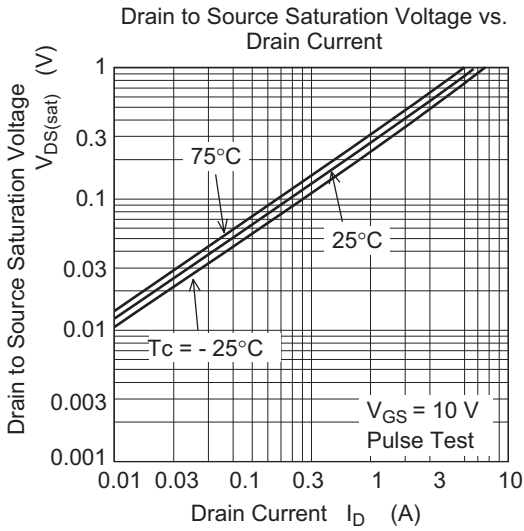

Package Dimensions

As of January, 2003
Unit: mm

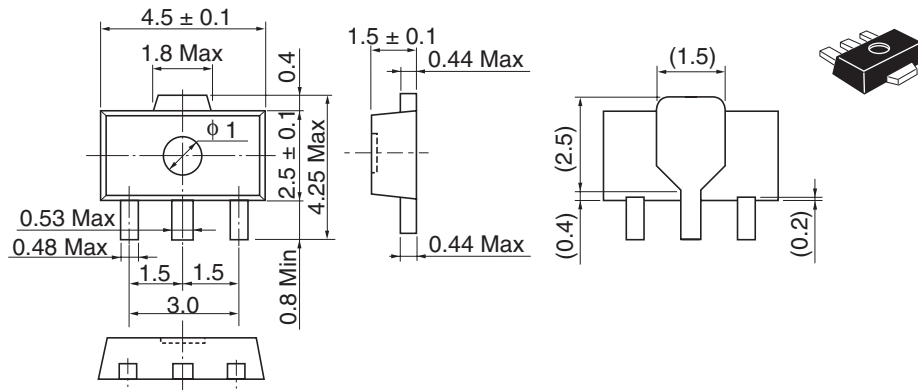

Package Code	UPAK
JEDEC	—
JEITA	Conforms
Mass (reference value)	0.050 g

Ordering Information

Part Name	Quantity	Shipping Container
2SK3391JX	1000	Taping

Note: For some grades, production may be terminated. Please contact the Renesas sales office to check the state of production before ordering the product.

Renesas Technology Corp. Sales Strategic Planning Div. Nippon Bldg., 2-6-2, Ohte-machi, Chiyoda-ku, Tokyo 100-0004, Japan

Keep safety first in your circuit designs!

1. Renesas Technology Corp. puts the maximum effort into making semiconductor products better and more reliable, but there is always the possibility that trouble may occur with them. Trouble with semiconductors may lead to personal injury, fire or property damage. Remember to give due consideration to safety when making your circuit designs, with appropriate measures such as (i) placement of substitutive, auxiliary circuits, (ii) use of nonflammable material or (iii) prevention against any malfunction or mishap.

Notes regarding these materials

1. These materials are intended as a reference to assist our customers in the selection of the Renesas Technology Corp. product best suited to the customer's application; they do not convey any license under any intellectual property rights, or any other rights, belonging to Renesas Technology Corp. or a third party.
 2. Renesas Technology Corp. assumes no responsibility for any damage, or infringement of any third-party's rights, originating in the use of any product data, diagrams, charts, programs, algorithms, or circuit application examples contained in these materials.
 3. All information contained in these materials, including product data, diagrams, charts, programs and algorithms represents information on products at the time of publication of these materials, and are subject to change by Renesas Technology Corp. without notice due to product improvements or other reasons. It is therefore recommended that customers contact Renesas Technology Corp. or an authorized Renesas Technology Corp. product distributor for the latest product information before purchasing a product listed herein.
The information described here may contain technical inaccuracies or typographical errors.
Renesas Technology Corp. assumes no responsibility for any damage, liability, or other loss rising from these inaccuracies or errors.
Please also pay attention to information published by Renesas Technology Corp. by various means, including the Renesas Technology Corp. Semiconductor home page (<http://www.renesas.com>).
 4. When using any or all of the information contained in these materials, including product data, diagrams, charts, programs, and algorithms, please be sure to evaluate all information as a total system before making a final decision on the applicability of the information and products. Renesas Technology Corp. assumes no responsibility for any damage, liability or other loss resulting from the information contained herein.
 5. Renesas Technology Corp. semiconductors are not designed or manufactured for use in a device or system that is used under circumstances in which human life is potentially at stake. Please contact Renesas Technology Corp. or an authorized Renesas Technology Corp. product distributor when considering the use of a product contained herein for any specific purposes, such as apparatus or systems for transportation, vehicular, medical, aerospace, nuclear, or undersea repeater use.
 6. The prior written approval of Renesas Technology Corp. is necessary to reprint or reproduce in whole or in part these materials.
 7. If these products or technologies are subject to the Japanese export control restrictions, they must be exported under a license from the Japanese government and cannot be imported into a country other than the approved destination.
Any diversion or reexport contrary to the export control laws and regulations of Japan and/or the country of destination is prohibited.
 8. Please contact Renesas Technology Corp. for further details on these materials or the products contained therein.
-



RENESAS SALES OFFICES

<http://www.renesas.com>

Renesas Technology America, Inc.

450 Holger Way, San Jose, CA 95134-1368, U.S.A
Tel: <1> (408) 382-7500 Fax: <1> (408) 382-7501

Renesas Technology Europe Limited.

Dukes Meadow, Millboard Road, Bourne End, Buckinghamshire, SL8 5FH, United Kingdom
Tel: <44> (1628) 585 100, Fax: <44> (1628) 585 900

Renesas Technology Europe GmbH

Dornacher Str. 3, D-85622 Feldkirchen, Germany
Tel: <49> (89) 380 70 0, Fax: <49> (89) 929 30 11

Renesas Technology Hong Kong Ltd.

7/F., North Tower, World Finance Centre, Harbour City, Canton Road, Hong Kong
Tel: <852> 2265-6688, Fax: <852> 2375-6836

Renesas Technology Taiwan Co., Ltd.

FL 10, #99, Fu-Hsing N. Rd., Taipei, Taiwan
Tel: <886> (2) 2715-2888, Fax: <886> (2) 2713-2999

Renesas Technology (Shanghai) Co., Ltd.

26/F., Ruijin Building, No.205 Maoming Road (S), Shanghai 200020, China
Tel: <86> (21) 6472-1001, Fax: <86> (21) 6415-2952

Renesas Technology Singapore Pte. Ltd.

1, Harbour Front Avenue, #06-10, Keppel Bay Tower, Singapore 098632
Tel: <65> 6213-0200, Fax: <65> 6278-8001

