

Triple-band VCO for GSM900/DCS1800/PCS1900

General Description

The LMX2604 is a fully integrated VCO (Voltage-Controlled Oscillator) IC designed for GSM900/DCS1800/PCS1900 triple-band application. The IC is ideal for use in the transmitter modulation loop by providing extremely small form factor and low phase noise. The IC has two VCOs, one for GSM and a second for DCS/PCS. The IC has two separate buffer amplifiers to drive an external high power amplifier, one for GSM900 band and the other one for DCS1800/PCS1900 bands. The IC also has a differential buffer amplifier to drive a mixer for the offset PLL.

The resonant circuits of the VCOs are fully integrated in the chip to ease the application of the IC. The high quality factor of the embedded tank circuit achieves very low phase noise characteristics at the VCO output. The only required external components are a couple of supply bypass capacitors and matching components.

A control pin for controlling the oscillation frequency is shared by the two VCOs.

The LMX2604 IC is provided in a 20-pin 4x4 LLP (Leadless Leadframe package).

Features

- On-chip Triple-band RF VCOs
 - GSM: 880 MHz to 915 MHz
 - DCS: 1710 MHz to 1785 MHz
 - PCS: 1850 MHz to 1910 MHz
- On-chip tank circuit
- Low phase noise
 - 167 dBc/Hz @ 20 MHz offset in GSM band
 - 163 dBc/Hz @ 20 MHz offset in DCS band
 - 162 dBc/Hz @ 20 MHz offset in PCS band
- High output power
 - +6 dBm in GSM mode
 - +6 dBm in DCS and PCS mode
- Low current consumption
 - 18 mA in GSM mode
 - 15 mA in DCS and PCS mode
- +2.6 V to +3.0 V supply voltage
- 0.25 μ m RF CMOS process
- Small 20-pin 4x4 LLP package

Applications

- Transmit VCO for GSM, DCS, and PCS
- Closed loop modulation systems

Functional Block Diagram

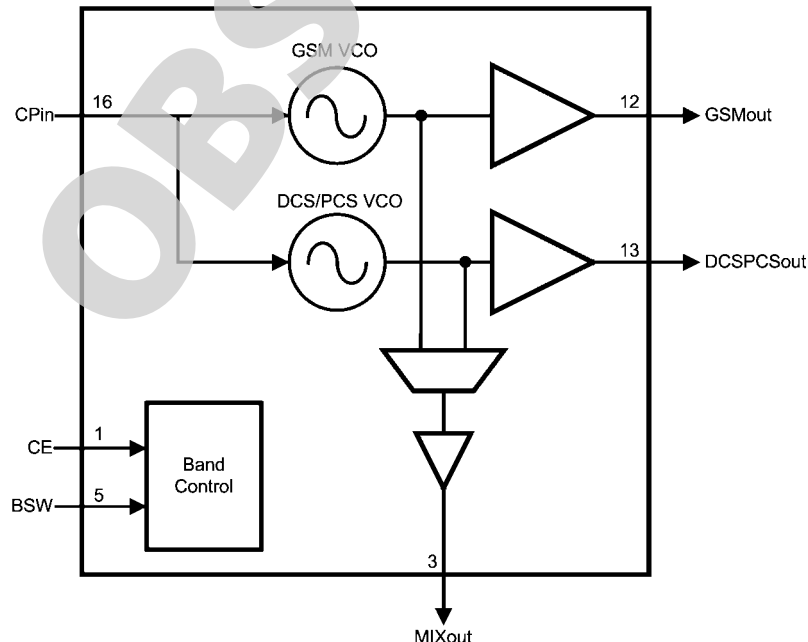

20066101

Connection Diagram

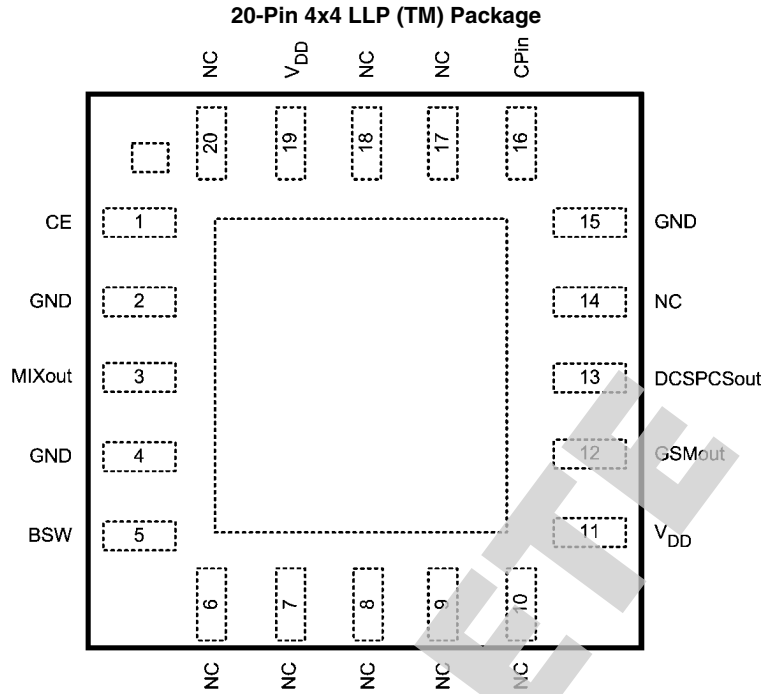

Pin Descriptions

Pin Number	Name	I/O	Description
1	CE	I	Chip enable input pin. High=enable, Low=disable
2,4,15	GND (<i>Note 1</i>)	—	Ground pins
3	MIXout	O	Mixer output pin (RF output)
5	BSW	I	Band switch input pin. High=DCS/PCS, Low=GSM
11,19	VDD	—	Supply voltage pins
12	GSMout	O	RF output pin for VCO in GSM band
13	DCSPCSout	O	RF output pin for VCO in DCS and PCS band
16	CPin	I	Charge pump input pin
6,7,8,9,10,14,17,18,20	NC	—	No Connection, These pins must be left open

Note 1: The exposed die attach pad is grounded.

Ordering Information

Package	Part Number	Package Marking	Media Transport	NSC Drawing
20-Pin LLP	LMX2604LQ	LMX2604LQ	1000 Unit Tape and Reel	LQA20A
20-Pin LLP	LMX2604LQX	LMX2604LQ	4500 Unit Tape and Reel	LQA20A

Absolute Maximum Ratings *(Note 3, Note 4, Note 5)*

Parameter	Symbol	Ratings	Unit
Supply Voltage	V_{DD}	-0.3 to 3.6	V
Input Voltage	V_{IN}	-0.3 to $V_{DD}+0.3$	V
Input Current <i>(Note 2)</i>	I_{IN}	10	mA
Storage Temperature Range	T_{STG}	-65 to 150	°C

Note 2: Maximum input current is for a logic pin, not the power pins.

Recommended Operating Conditions

Parameter	Symbol	Condition	Min	Typical	Max	Unit
Ambient Temperature	T_A	$V_{DD}=3V$	-30	25	85	°C
Supply Voltage (to GND)	V_{DD}		2.6	2.8	3.0	V

Note 3: "Absolute Maximum Ratings" indicate limits beyond which damage to the device may occur. Operating Ratings indicate conditions for which the device is intended to be functional, but do not guarantee specific performance limits. For guaranteed specifications and test conditions, see the Electrical Characteristics. The guaranteed specifications apply only for the test conditions listed.

Note 4: This Device is a high performance RF integrated circuit with an ESD rating < 2 kV and is ESD sensitive. Handling and assembly of this device should only be done at ESD-free workstations.

Note 5: Stresses in excess of the absolute maximum ratings can cause permanent or latent damage to the device. These are absolute stress ratings only. Functional operation of the device is only implied at these or any other conditions in excess of those given in the operation sections of the data sheet. Exposure to absolute maximum ratings for extended periods can adversely affect device reliability.

AC Electrical Characteristics

($V_{DD}=2.8V$, $T_A=25^\circ C$; unless otherwise noted)

Symbol	Parameter	Remarks	Min	Typ	Max	Units
f	Frequency Range	GSM Band	880		915	MHz
		DCS Band	1710		1785	MHz
		PCS Band	1850		1910	
K_{VCO}	Tuning Sensitivity <i>(Note 6)</i>	GSM Band	10	15	20	MHz/V
		DCS Band	15	20	25	
		PCS Band	20	25	30	
P _{out}	Output Power	GSM Band	4	6	8	dBm
		DCS & PCS Band	4	6	8	
PMIX _{out}	Output power of MIX _{out} pin	GSM Band	-5.5	-3.5	-1.5	dBm
		DCS & PCS Band	-4.5	-2.5	-0.5	
L(f)	Phase Noise (GSM Band)	at 100 kHz offset		-120		dBc/Hz
		at 400 kHz offset		-136	-128	
		at 3 MHz offset <i>(Note 7)</i>		-152		
		at 20 MHz offset <i>(Note 7)</i>		-167		
L(f)	Phase Noise (DCS Band)	at 100 kHz offset		-112	-124	dBc/Hz
		at 400 kHz offset		-130		
		at 3 MHz offset <i>(Note 7)</i>		-146		
		at 20 MHz offset <i>(Note 7)</i>		-163		
L(f)	Phase Noise (PCS Band)	at 100 kHz offset		-110	-124	dBc/Hz
		at 400 kHz offset		-129		
		at 3 MHz offset <i>(Note 7)</i>		-145		
		at 20 MHz offset <i>(Note 7)</i>		-162		
	Second Harmonic Suppression	All Bands at RF output port.		-20	-15	dBc

Note 6: Tuning Sensitivity is measured after coarse lock. Minimum and maximum limits are supported by characterization.

Note 7: Supported by characterization

DC Electrical Characteristics

($V_{DD}=2.8V$, $T_A=25^{\circ}C$; unless otherwise noted)

Symbol	Parameter	Condition	Min	Typ	Max	Units
V_{IH}	Logical Input High Voltage		$0.8V_{DD}$		$V_{DD}+0.3$	V
V_{IL}	Logical Input Low Voltage		-0.3		$0.2V_{DD}$	V
I_{IH}	Logical Input High Current		-2.5		2.5	μA
I_{IL}	Logical Input Low Current		-2.5		2.5	μA
	Input Capacitance			5		pF
$I_{DD,GSM}$	Supply Current (<i>Note 8</i>)			18	21	mA
$I_{DD,DCS/PCS}$	Supply Current (<i>Note 8</i>)			15	18	mA
I_{std}	Standby Current				2.5	μA

Note 8: The current consumption in VCO and driver amplifier is all included

Note 9: For CE, BSW, and CPin pins

OBSOLETE

Typical Performance Characteristics : Phase Noise

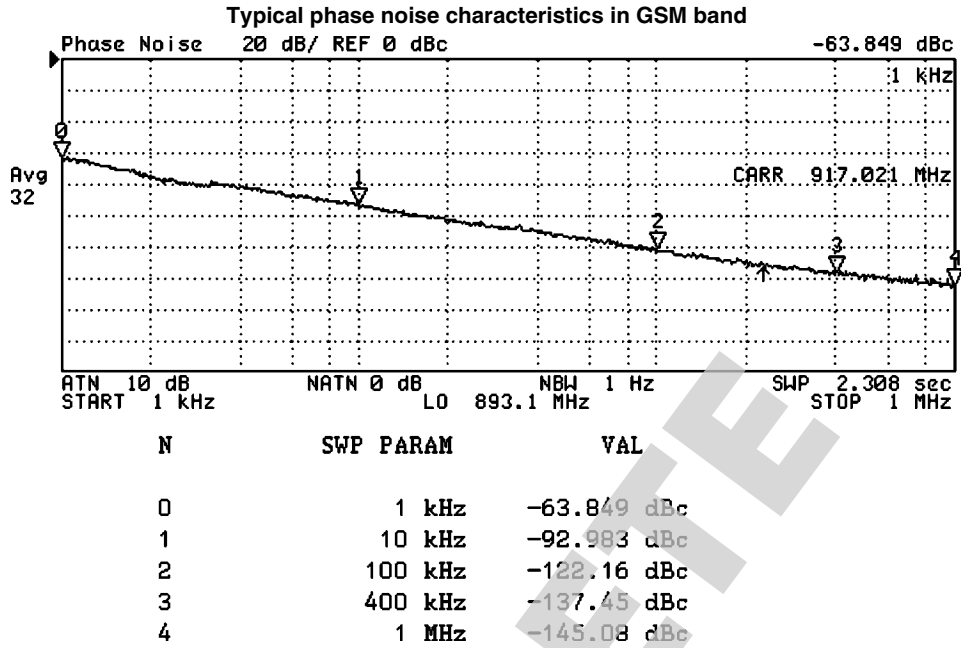

20066161

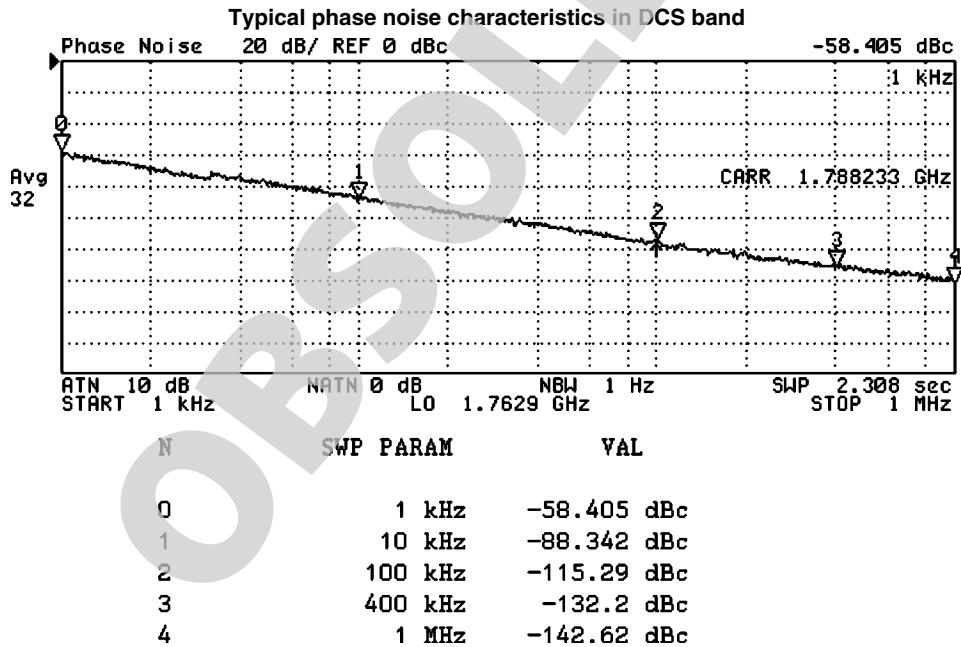

20066162

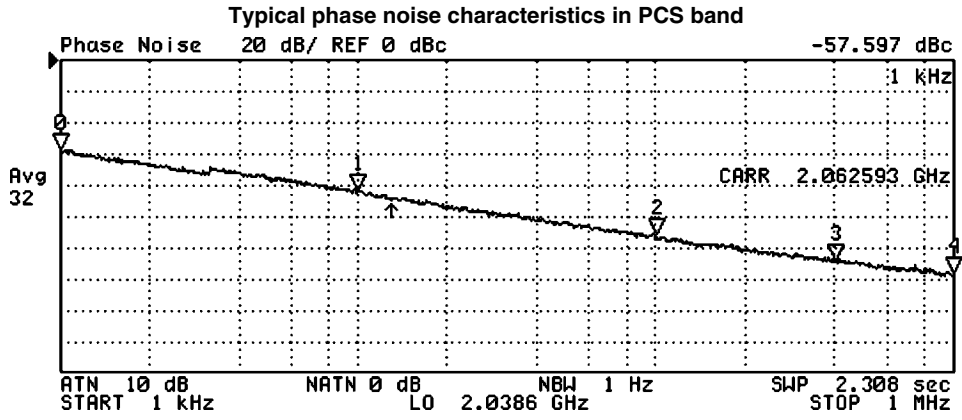

N	SWP PARAM	VAL
0	1 kHz	-57.597 dBc
1	10 kHz	-84.194 dBc
2	100 kHz	-112.45 dBc
3	400 kHz	-129.21 dBc
4	1 MHz	-137.5 dBc

20066163

OBSOLETE

Typical Performance Characteristic : GSMout Impedance

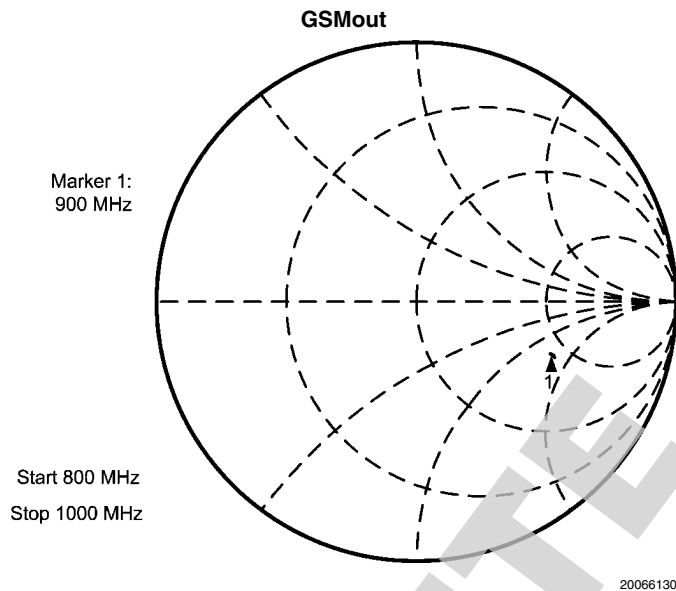

GSMout			
Frequency (MHz)	Real (Ohms)	Imaginary (Ohms)	Absolute (Ohms)
800	126	-72	146
850	126	-74	146
900	126	-75	146
950	126	-77	147
1000	125	-80	149

Typical Performance Characteristic : MIXout Impedance, GSM

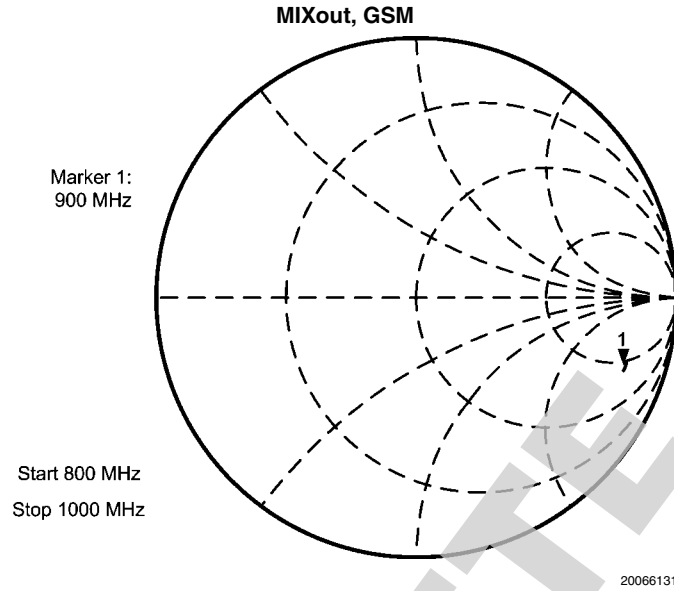

MIXout, GSM			
Frequency (MHz)	Real (Ohms)	Imaginary (Ohms)	Absolute (Ohms)
800	141	-256	292
850	133	-249	282
900	126	-243	274
950	120	-237	266
1000	115	-232	259

Typical Performance Characteristic : DCSPCSout Impedance

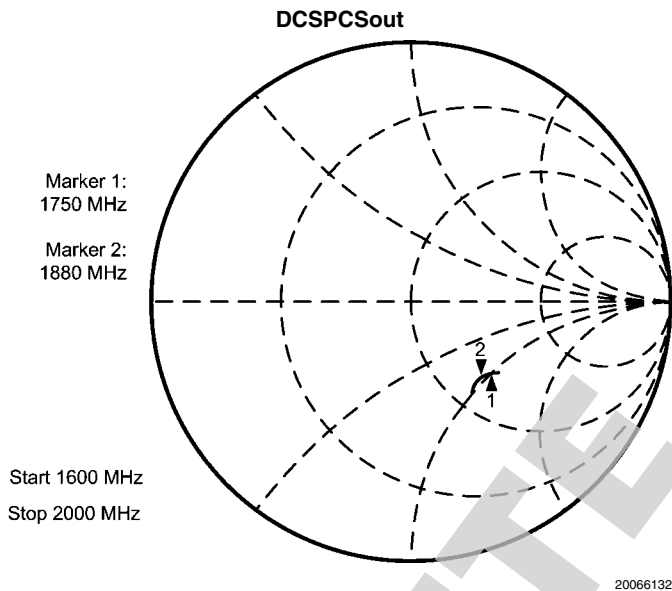

DCSPCSout			
Frequency (MHz)	Real (Ohms)	Imaginary (Ohms)	Absolute (Ohms)
1600	80	-54	96
1650	78	-53	94
1700	77	-51	93
1750	76	-50	91
1800	73	-49	88
1850	71	-48	85
1900	68	-48	83
1950	64	-48	80
2000	57	-51	77

Typical Performance Characteristic : MIXout Impedance, DCS/PCS

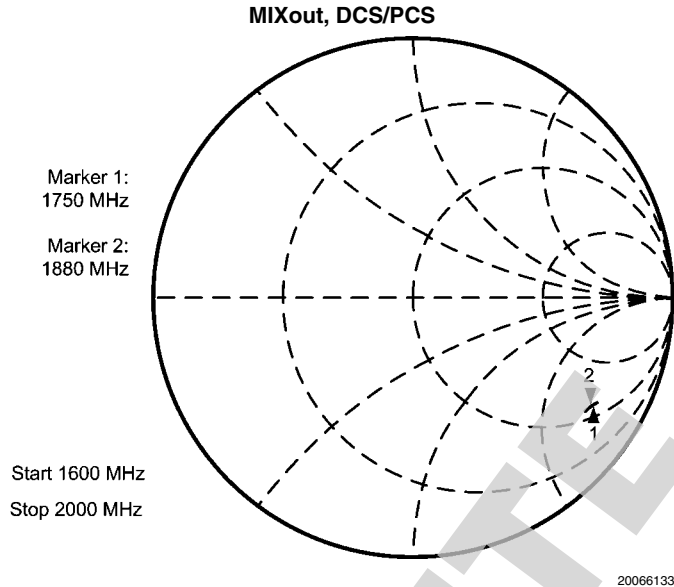

MIXout, DCSPCS			
Frequency (MHz)	Real (Ohms)	Imaginary (Ohms)	Absolute (Ohms)
1600	66	-164	177
1650	65	-162	175
1700	64	-160	172
1750	66	-157	171
1800	64	-157	169
1850	63	-153	166
1900	62	-150	162
1950	61	-146	159
2000	59	-143	155

Functional Description

PRODUCT DESCRIPTION

The LMX2604 IC has two VCOs, which are configured as an LC resonant oscillator. The active components and tank elements are all integrated on the IC. The oscillator core and the tank circuit are designed to be immune to external noise such as supply and load variation. The IC is easy-to-use and occupies extremely small area in the board.

Two output amplifiers are also integrated to deliver high output power of +6 dBm in GSM/DCS/PCS applications. The amplifiers isolate the oscillator cores from the external load, and drive the external 50 ohm load. The output driver is designed to have low noise floor and to reduce pulling by load variation. An additional amplifier to drive the mixer in the transmit PLL is also provided. Only an attenuator composed of a few passive elements is necessary to meet the power level of the mixer input of the transmit PLL.

The frequency of the oscillator is controlled by the CPin pin, which is internally connected to the varactor. This control pin is connected to the loop filter of the modulation loop in the transmit path. Any additional noise on this tuning input is directly translated into FM noise, which can degrade the phase noise characteristics of the oscillator. Typically, the loop filter of the PLL provides an appropriately low impedance source at its output and thus proper additional filtering stage is often required to reduce the high frequency noise and spurious signals.

FREQUENCY SELECTION AND POWER DOWN CONTROL

The BSW pin selects the operating frequency band. The table below shows the appropriate settings with the CE pin.

CE	BSW	Output
Low	Low	X
Low	High	X
High	Low	Low Band (GSM)
High	High	High Band (DCS/PCS)

In real implementation, the component values of the tank circuit vary from the nominal value. The IC has built-in circuit to track the variation and compensate that kind of the variation during normal operation. This self-correction algorithm does not require any external control signal and elements. The figure below shows an application circuit of the LMX2604. The LMX2604 is developed for the use in a GSM handset as part of the transmitter PLL. To complete the offset PLL in the transmit path, several passive elements for the external loop filter should be also provided. The charge pump output port of the external transceiver IC is fed to the CPin pin.

The locking process of the LMX2604 is composed of two stages. First, the internal control circuitry of the LMX2604 controls the fast frequency acquisition behavior of the LMX2604. After the frequency acquisition, the whole loop enters in its normal operating mode.

Application Circuit of LMX2604

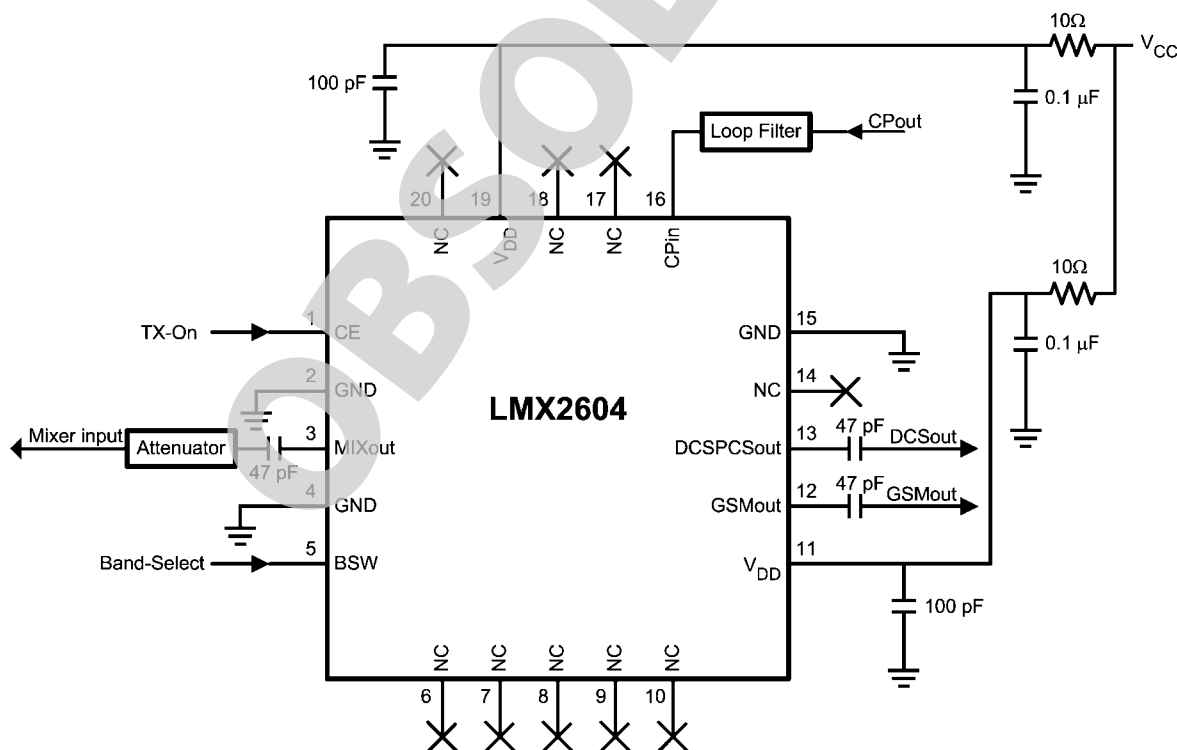

20066172

FREQUENCY ACQUISITION

On the rising edge of CE the VCO goes through a frequency acquisition mode which coarse locks the PLL to the approximate final frequency. This portion of the lock digitally sets the frequency such that the final tuning voltage on the CPin line

of the VCO is approximately $V_{dd}/2$. Benefits of this system is the maximum required charge pump voltage is reduced as large frequency ranges may be tuned with a small tuning voltage. This makes the digitally tuned VCO different from conventional analog VCOs.

Frequency Acquisition Timing Diagram

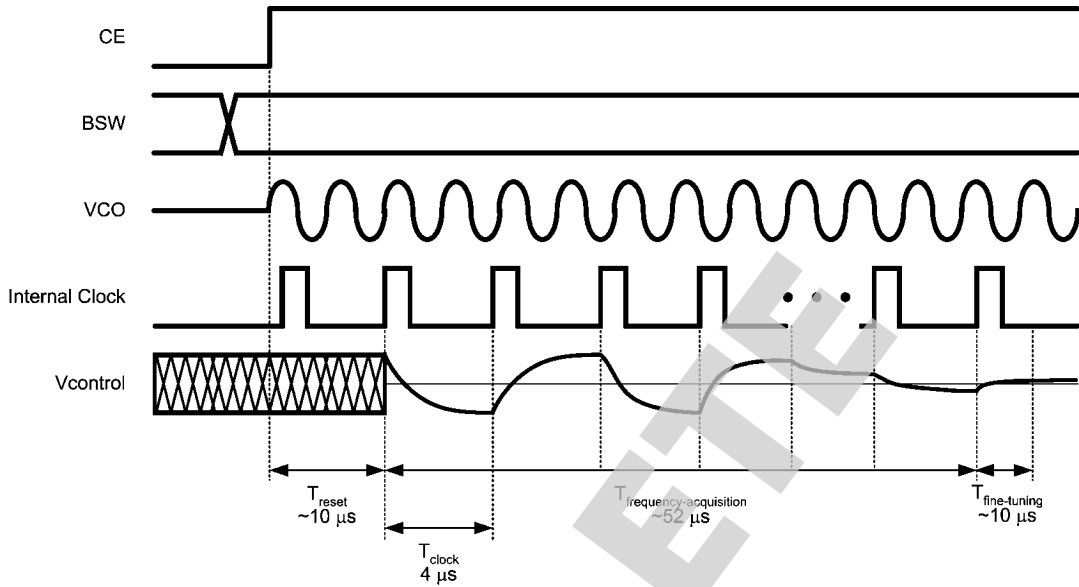

20066122

OBSOLETE

Physical Dimensions inches (millimeters) unless otherwise noted

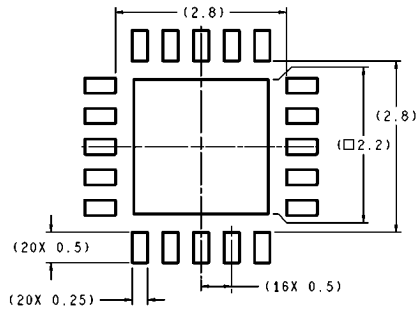

RECOMMENDED LAND PATTERN
1:1 RATIO WITH PKG SOLDER PADS

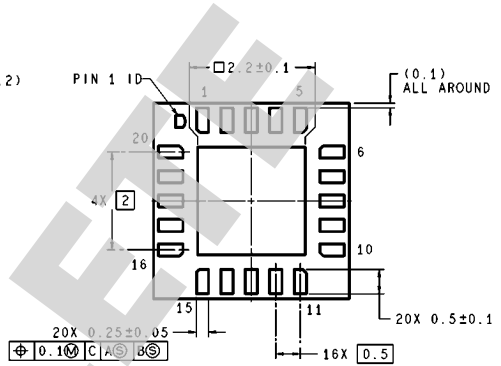
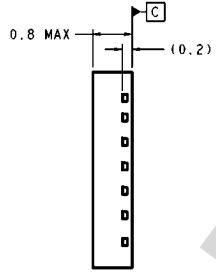
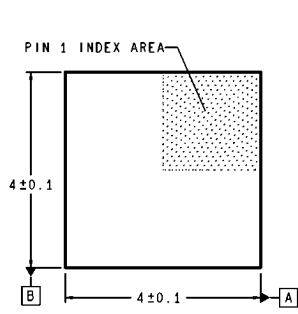

DIMENSIONS ARE IN MILLIMETERS

LQA20A (Rev. A)

20-Pin LLP (Leadless Leadframe package) Package
Order Number LMX2604LQX for 4500 Unit Reel
Order Number LMX2604LQ for 1000 Unit Reel
NS Package Number LQA20

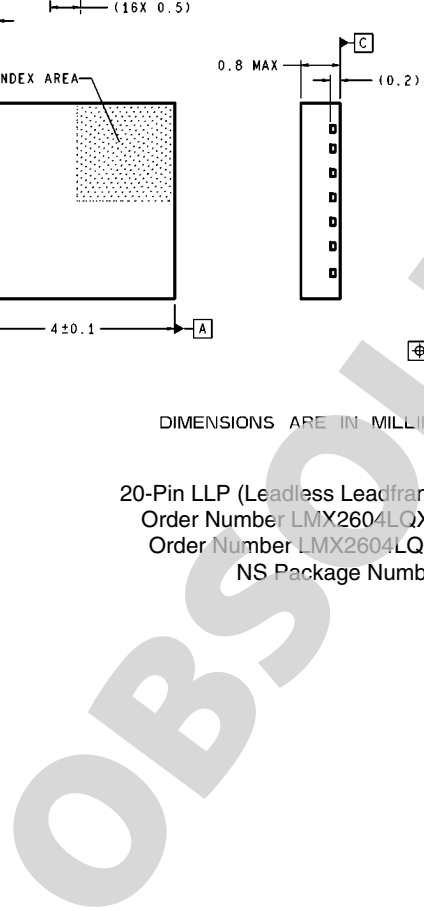

Notes

For more National Semiconductor product information and proven design tools, visit the following Web sites at:
www.national.com

Products		Design Support	
Amplifiers	www.national.com/amplifiers	WEBENCH® Tools	www.national.com/webench
Audio	www.national.com/audio	App Notes	www.national.com/appnotes
Clock and Timing	www.national.com/timing	Reference Designs	www.national.com/refdesigns
Data Converters	www.national.com/adc	Samples	www.national.com/samples
Interface	www.national.com/interface	Eval Boards	www.national.com/evalboards
LVDS	www.national.com/lvds	Packaging	www.national.com/packaging
Power Management	www.national.com/power	Green Compliance	www.national.com/quality/green
Switching Regulators	www.national.com/switchers	Distributors	www.national.com/contacts
LDOs	www.national.com/ldo	Quality and Reliability	www.national.com/quality
LED Lighting	www.national.com/led	Feedback/Support	www.national.com/feedback
Voltage References	www.national.com/vref	Design Made Easy	www.national.com/easy
PowerWise® Solutions	www.national.com/powerwise	Applications & Markets	www.national.com/solutions
Serial Digital Interface (SDI)	www.national.com/sdi	Mil/Aero	www.national.com/milaero
Temperature Sensors	www.national.com/tempensors	SolarMagic™	www.national.com/solarmagic
PLL/VCO	www.national.com/wireless	PowerWise® Design University	www.national.com/training

THE CONTENTS OF THIS DOCUMENT ARE PROVIDED IN CONNECTION WITH NATIONAL SEMICONDUCTOR CORPORATION ("NATIONAL") PRODUCTS. NATIONAL MAKES NO REPRESENTATIONS OR WARRANTIES WITH RESPECT TO THE ACCURACY OR COMPLETENESS OF THE CONTENTS OF THIS PUBLICATION AND RESERVES THE RIGHT TO MAKE CHANGES TO SPECIFICATIONS AND PRODUCT DESCRIPTIONS AT ANY TIME WITHOUT NOTICE. NO LICENSE, WHETHER EXPRESS, IMPLIED, ARISING BY ESTOPPEL OR OTHERWISE, TO ANY INTELLECTUAL PROPERTY RIGHTS IS GRANTED BY THIS DOCUMENT.

TESTING AND OTHER QUALITY CONTROLS ARE USED TO THE EXTENT NATIONAL DEEMS NECESSARY TO SUPPORT NATIONAL'S PRODUCT WARRANTY. EXCEPT WHERE MANDATED BY GOVERNMENT REQUIREMENTS, TESTING OF ALL PARAMETERS OF EACH PRODUCT IS NOT NECESSARILY PERFORMED. NATIONAL ASSUMES NO LIABILITY FOR APPLICATIONS ASSISTANCE OR BUYER PRODUCT DESIGN. BUYERS ARE RESPONSIBLE FOR THEIR PRODUCTS AND APPLICATIONS USING NATIONAL COMPONENTS. PRIOR TO USING OR DISTRIBUTING ANY PRODUCTS THAT INCLUDE NATIONAL COMPONENTS, BUYERS SHOULD PROVIDE ADEQUATE DESIGN, TESTING AND OPERATING SAFEGUARDS.

EXCEPT AS PROVIDED IN NATIONAL'S TERMS AND CONDITIONS OF SALE FOR SUCH PRODUCTS, NATIONAL ASSUMES NO LIABILITY WHATSOEVER, AND NATIONAL DISCLAIMS ANY EXPRESS OR IMPLIED WARRANTY RELATING TO THE SALE AND/OR USE OF NATIONAL PRODUCTS INCLUDING LIABILITY OR WARRANTIES RELATING TO FITNESS FOR A PARTICULAR PURPOSE, MERCHANTABILITY, OR INFRINGEMENT OF ANY PATENT, COPYRIGHT OR OTHER INTELLECTUAL PROPERTY RIGHT.

LIFE SUPPORT POLICY

NATIONAL'S PRODUCTS ARE NOT AUTHORIZED FOR USE AS CRITICAL COMPONENTS IN LIFE SUPPORT DEVICES OR SYSTEMS WITHOUT THE EXPRESS PRIOR WRITTEN APPROVAL OF THE CHIEF EXECUTIVE OFFICER AND GENERAL COUNSEL OF NATIONAL SEMICONDUCTOR CORPORATION. As used herein:

Life support devices or systems are devices which (a) are intended for surgical implant into the body, or (b) support or sustain life and whose failure to perform when properly used in accordance with instructions for use provided in the labeling can be reasonably expected to result in a significant injury to the user. A critical component is any component in a life support device or system whose failure to perform can be reasonably expected to cause the failure of the life support device or system or to affect its safety or effectiveness.

National Semiconductor and the National Semiconductor logo are registered trademarks of National Semiconductor Corporation. All other brand or product names may be trademarks or registered trademarks of their respective holders.

Copyright© 2011 National Semiconductor Corporation

For the most current product information visit us at www.national.com

 **National Semiconductor Americas Technical Support Center**
 Email: support@nsc.com
 Tel: 1-800-272-9959

National Semiconductor Europe Technical Support Center
 Email: europe.support@nsc.com

National Semiconductor Asia Pacific Technical Support Center
 Email: ap.support@nsc.com

National Semiconductor Japan Technical Support Center
 Email: jpn.feedback@nsc.com