

Superior Efficacy & Lumen output with Small Form Factor

Z Power LED – Z5-M4

S1W0-3535xxxx03-00000000-00004

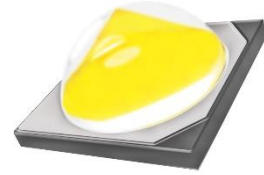

Product Brief

Description

- The Z-Power series is designed for high flux output applications with high current operation capability.
- It incorporates state of the art SMD design and low thermal resistant material.
- The Z Power LED is ideal light sources for directional lighting applications such as Spot Lights, various outdoor applications, automotive lightings and high performance torches .

Features and Benefits

- High Lumen Output and Efficacy
- Designed for high current operation
- Low Thermal Resistance
- ANSI compliant Binning
- Ceramic package

Key Applications

- Architectural
- Industrial
- Outdoor area
- Exterior Lighting
- Commercial



Table 1. Product Selection (Order Code Table)

Part Number	Color	Nominal CCT	Order Code	CRI
				Min
SZ5-M4-W0-C7	Pure Cool White	7500K	S1W0-3535757003-00000000-00004	70
		6500K	S1W0-3535657003-00000000-00004	
	Cool White	5700K	S1W0-3535577003-00000000-00004	
		5000K	S1W0-3535507003-00000000-00004	
SZ5-M4-WN-C7	Neutral White	4000K	S1W0-3535407003-00000000-00004	
SZ5-M4-WW-C7	Warm White	3500K	S1W0-3535357003-00000000-00004	
		3000K	S1W0-3535307003-00000000-00004	
		2700K	S1W0-3535277003-00000000-00004	
	Soft Warm White	2200K	S1W0-3535227003-00000000-00004	
SZ5-M4-W0-C8	Cool White	6500K	S1W0-3535658003-00000000-00004	80
		5700K	S1W0-3535578003-00000000-00004	
		5000K	S1W0-3535508003-00000000-00004	
SZ5-M4-WN-C8	Neutral White	4000K	S1W0-3535408003-00000000-00004	
SZ5-M4-WW-C8	Warm White	3500K	S1W0-3535358003-00000000-00004	
		3000K	S1W0-3535308003-00000000-00004	
		2700K	S1W0-3535278003-00000000-00004	
SZ5-M4-W0-C9	Cool White	6500K	S1W0-3535659003-00000000-00004	90
		5700K	S1W0-3535579003-00000000-00004	
		5000K	S1W0-3535509003-00000000-00004	
SZ5-M4-WN-C9	Neutral White	4000K	S1W0-3535409003-00000000-00004	
SZ5-M4-WW-C9	Warm White	3500K	S1W0-3535359003-00000000-00004	
		3000K	S1W0-3535309003-00000000-00004	
		2700K	S1W0-3535279003-00000000-00004	

Table of Contents

Index	
• Product Brief	1
• Table of Contents	3
• Performance Characteristics	4
• Characteristics Graph	5
• Color Bin Structure	10
• Mechanical Dimensions	18
• Recommended Solder Pad	19
• Reflow Soldering Characteristics	20
• Emitter Tape & Reel Packaging	21
• Packing Information	22
• Product Nomenclature	23
• Handling of Silicone Resin for LEDs	24
• Precaution For Use	25
• Company Information	28

Performance Characteristics

Table 2. Characteristics

Parameter	Symbol	Value			Unit
		Min.	Typ.	Max. ^[4]	
Forward Current	I_F	-	700	2000 ^[1]	mA
Peak Pulsed Forward Current ^[2]	I_F			2600	mA
Forward Voltage (@700mA, 85°C)	V_F	-	-	2.95	V
Junction Temperature	T_j	-	-	150	°C
Operating Temperature	T_{op}	-40	-	105	°C
Storage Temperature	T_{stg}	-40	-	120	°C
Viewing angle	θ		120		degree
Thermal resistance (J to S) ^[3]	$R\theta_{J-S}$	-	3	-	K/W
ESD Sensitivity(HBM)		Class 3B JEDEC JS-001-2017			

Notes :

- [1] At Junction Temperature 25°C condition.
 [2] Pulse width ≤10ms, duty cycle ≤ 10% condition.
 [3] $R\theta_{J-S}$ is tested at 700mA.

- It is recommended to use it in the condition that the reliability is secured within the Max value.
- Thermal resistance can be increased substantially depending on the heat sink design/operating condition, and the maximum possible driving current will decrease accordingly.

Characteristics Graph

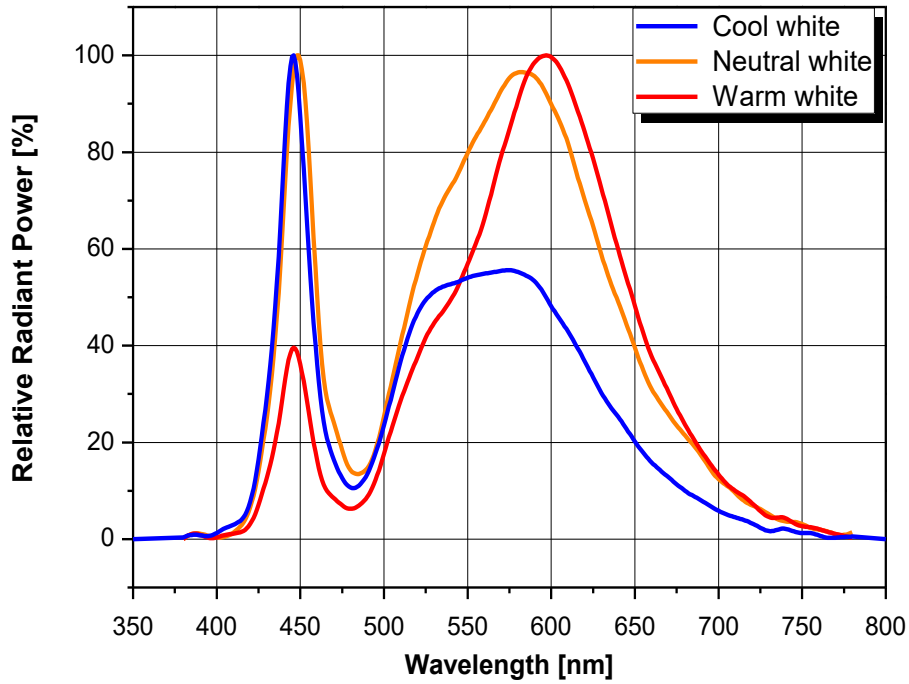
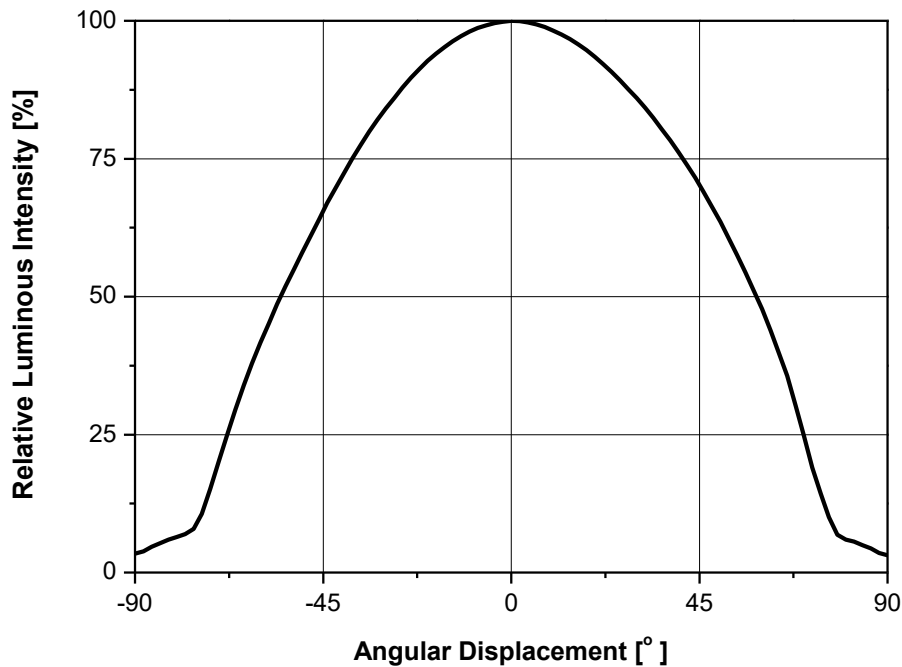
Fig 1. Color Spectrum

Fig 2. Typical Spatial Distribution

Characteristics Graph

Fig 3. Forward Voltage vs. Forward Current, $T_j=85^\circ\text{C}$

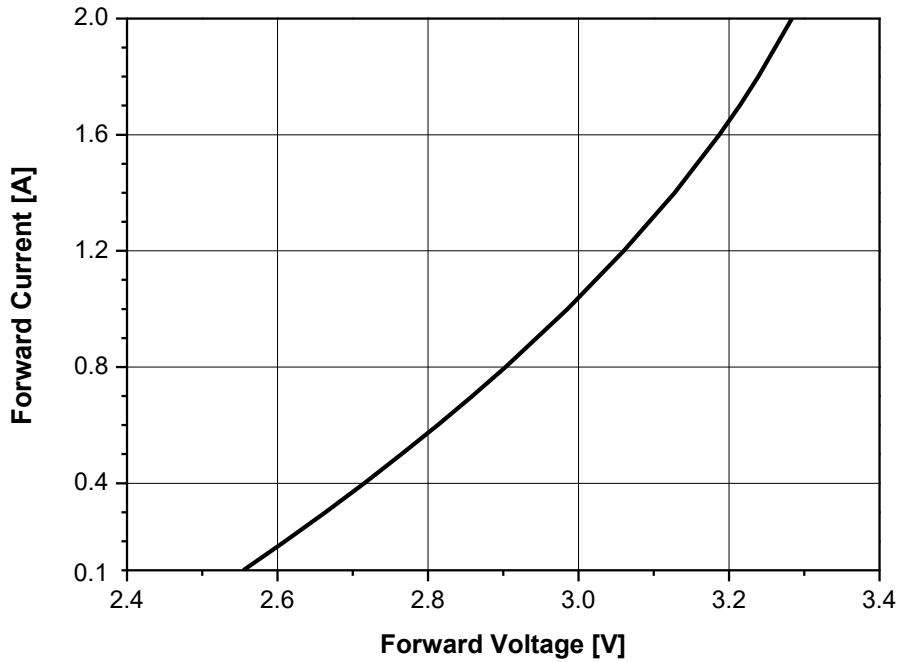
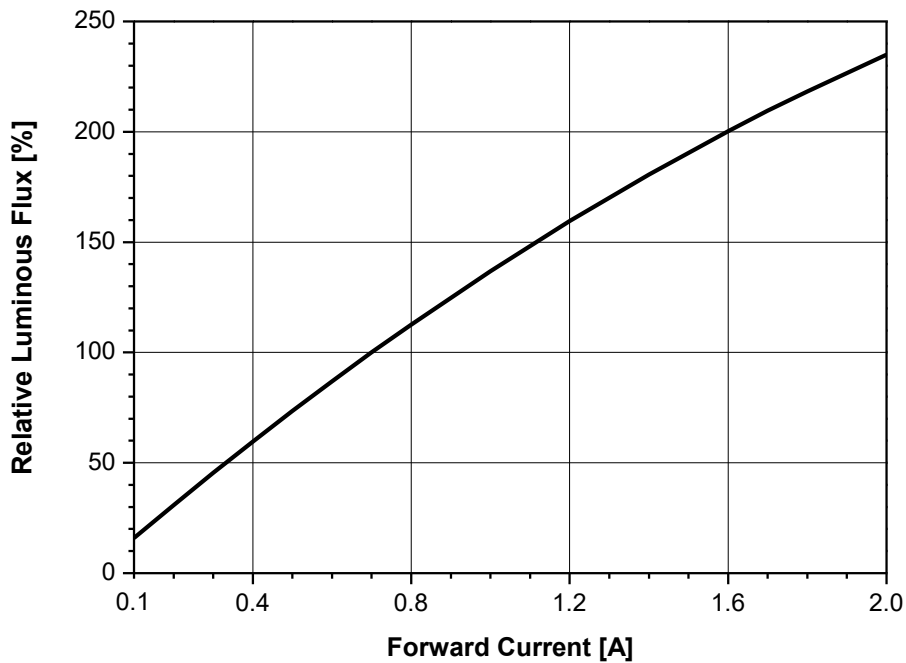
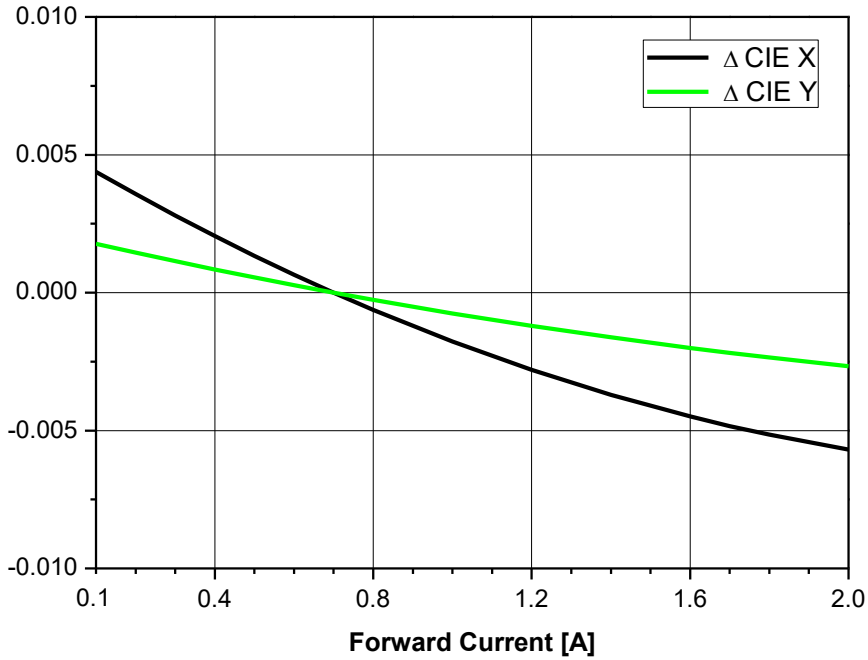
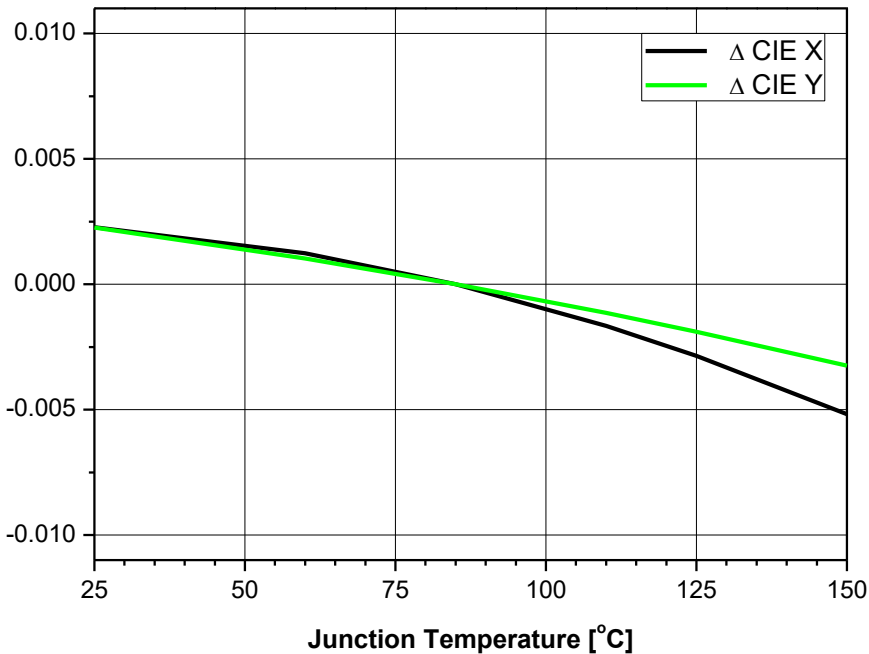

Fig 4. Forward Current vs. Relative Luminous Flux, $T_j=85^\circ\text{C}$



- Using less than 100mA is not recommended

Characteristics Graph

Fig 5. Forward Current vs. CIE X, Y Shift, $T_j=85^\circ\text{C}$

Fig 6. Junction Temp. vs. CIE X, Y Shift, $I_F=700\text{mA}$

- Using less than 100mA is not recommended

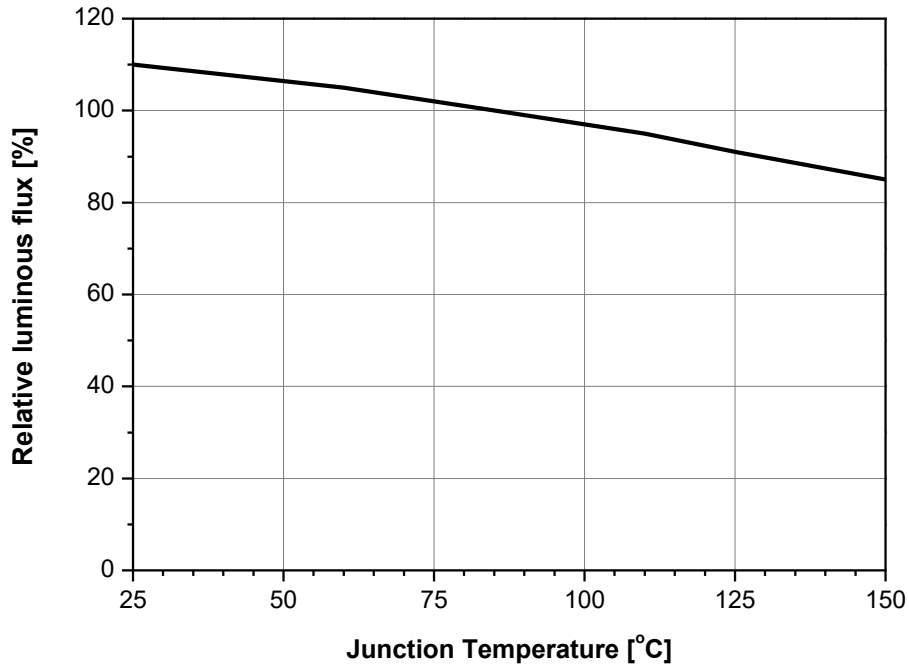
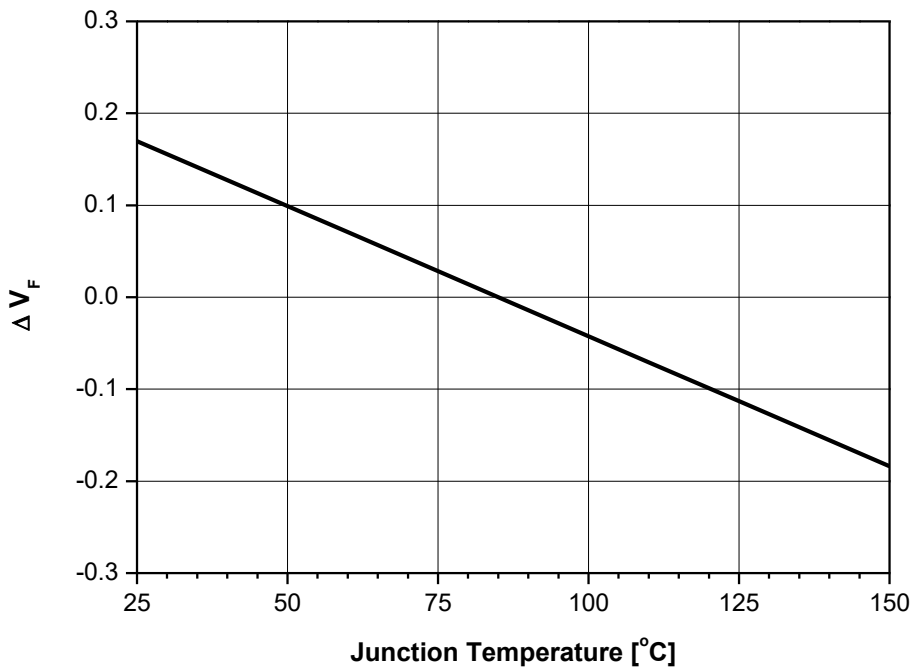
Characteristics Graph

Fig 7. Relative Light Output vs. Junction Temperature, $I_F=700\text{mA}$

Fig 8. Relative Forward Voltage vs. Junction Temperature, $I_F=700\text{mA}$

Characteristics Graph

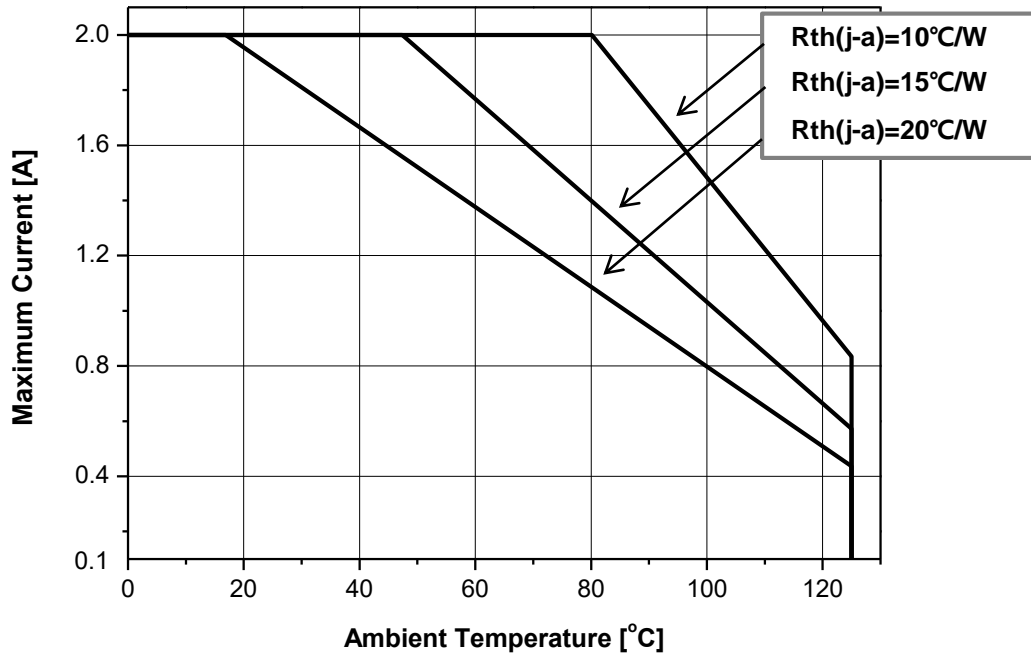
Fig 9. Maximum Forward Current vs. Ambient Temperature, $T_j(\text{max.})=150^\circ\text{C}$



- Using less than 100mA is not recommended

Color Bin Structure

Table 3. CRI70, Bin Code description, $I_F=700\text{mA}$, $T_j=85^\circ\text{C}$

Luminous Flux [lm]			Typical Forward Voltage [V_F]		
Bin Code	Min.	Max.	Bin Code	Min.	Max.
W2	254	271	G	2.75	2.95
W3	271	285			
W4	285	299			
W5	299	313			
W6	313	327			
W7	327	340			
W8	340	355			
W9	355	370			
X11	370	385			

Table 4. CRI70, Flux Rank Distribution
Available Rank

CCT	CIE	Flux Rank								
		W2	W3	W4	W5	W6	W7	W8	W9	X11
8200K-7000K	Z	W2	W3	W4	W5	W6	W7	W8	W9	X11
6000 ~ 7000K	A	W2	W3	W4	W5	W6	W7	W8	W9	X11
5300 ~ 6000K	B	W2	W3	W4	W5	W6	W7	W8	W9	X11
4700 ~ 5300K	C	W2	W3	W4	W5	W6	W7	W8	W9	X11
3700 ~ 4200K	E	W2	W3	W4	W5	W6	W7	W8	W9	X11
3200 ~ 3700K	F	W2	W3	W4	W5	W6	W7	W8	W9	X11
2900 ~ 3200K	G	W2	W3	W4	W5	W6	W7	W8	W9	X11
2600 ~ 2900K	H	W2	W3	W4	W5	W6	W7	W8	W9	X11
2300 ~ 2100K	K	W2	W3	W4	W5	W6	W7	W8	W9	X11

Notes : (1) Correlated Color Temperature is derived from the CIE 1931 Chromaticity diagram.

Color coordinate : ± 0.005 , CCT $\pm 5\%$ tolerance.

(2) Seoul Semiconductor maintains a tolerance of $\pm 7\%$ on flux and power measurements.

(3) Φ_v is the total luminous flux output as measured with an integrating sphere.

(4) Tolerance is ± 2.0 on CRI measurements.

(5) Tolerance is $\pm 0.06\text{V}$ on forward voltage measurements.

Color Bin Structure

Table 5. CRI80, Bin Code description, $I_F=700mA$, $T_j=85^\circ C$

Luminous Flux [lm]			Typical Forward Voltage [V_F]		
Bin Code	Min.	Max.	Bin Code	Min.	Max.
W2	254	271	G	2.75	2.95
W3	271	285			
W4	285	299			
W5	299	313			
W6	313	327			
W7	327	340			
W8	340	355			

Table 6. CRI80, Flux Rank Distribution

CCT	CIE	Flux Rank							
		W2	W3	W4	W5	W6	W7	W8	
6000 ~ 7000K	A	W2	W3	W4	W5	W6	W7	W8	
5300 ~ 6000K	B	W2	W3	W4	W5	W6	W7	W8	
4700 ~ 5300K	C	W2	W3	W4	W5	W6	W7	W8	
3700 ~ 4200K	E	W2	W3	W4	W5	W6	W7	W8	
3200 ~ 3700K	F	W2	W3	W4	W5	W6	W7	W8	
2900 ~ 3200K	G	W2	W3	W4	W5	W6	W7	W8	
2600 ~ 2900K	H	W2	W3	W4	W5	W6	W7	W8	

Available Rank

Notes : (1) Correlated Color Temperature is derived from the CIE 1931 Chromaticity diagram.

Color coordinate : ± 0.005 , CCT $\pm 5\%$ tolerance.

(2) Seoul Semiconductor maintains a tolerance of $\pm 7\%$ on flux and power measurements.

(3) Φ_v is the total luminous flux output as measured with an integrating sphere.

(4) Tolerance is ± 2.0 on CRI measurements.

(5) Tolerance is $\pm 0.06V$ on forward voltage measurements.

Color Bin Structure

Table 7. CRI90, Bin Code description, $I_F=700\text{mA}$, $T_j=85^\circ\text{C}$

Luminous Flux [lm]			Typical Forward Voltage [V_F]		
Bin Code	Min.	Max.	Bin Code	Min.	Max.
V3	223	237	G	2.75	2.95
W1	237	254			
W2	254	271			
W3	271	285			
W4	285	299			
W5	299	313			

Table 8. CRI90, Flux Rank Distribution

CCT	CIE	Flux Rank						
		V2	V3	W1	W2	W3	W4	W5
6000 ~ 7000K	A	V2	V3	W1	W2	W3	W4	W5
5300 ~ 6000K	B	V2	V3	W1	W2	W3	W4	W5
4700 ~ 5300K	C	V2	V3	W1	W2	W3	W4	W5
3700 ~ 4200K	E	V2	V3	W1	W2	W3	W4	W5
3200 ~ 3700K	F	V2	V3	W1	W2	W3	W4	W5
2900 ~ 3200K	G	V2	V3	W1	W2	W3	W4	W5
2600 ~ 2900K	H	V2	V3	W1	W2	W3	W4	W5

Available Rank

Notes : (1) Correlated Color Temperature is derived from the CIE 1931 Chromaticity diagram.

Color coordinate : ± 0.005 , CCT $\pm 5\%$ tolerance.

(2) Seoul Semiconductor maintains a tolerance of $\pm 7\%$ on flux and power measurements.

(3) Φ_v is the total luminous flux output as measured with an integrating sphere.

(4) Tolerance is ± 2.0 on CRI measurements.

(5) Tolerance is $\pm 0.06\text{V}$ on forward voltage measurements.

Color Bin Structure

CIE Chromaticity Diagram (Pure White), $T_j=85^\circ\text{C}$, $I_F=700\text{mA}$

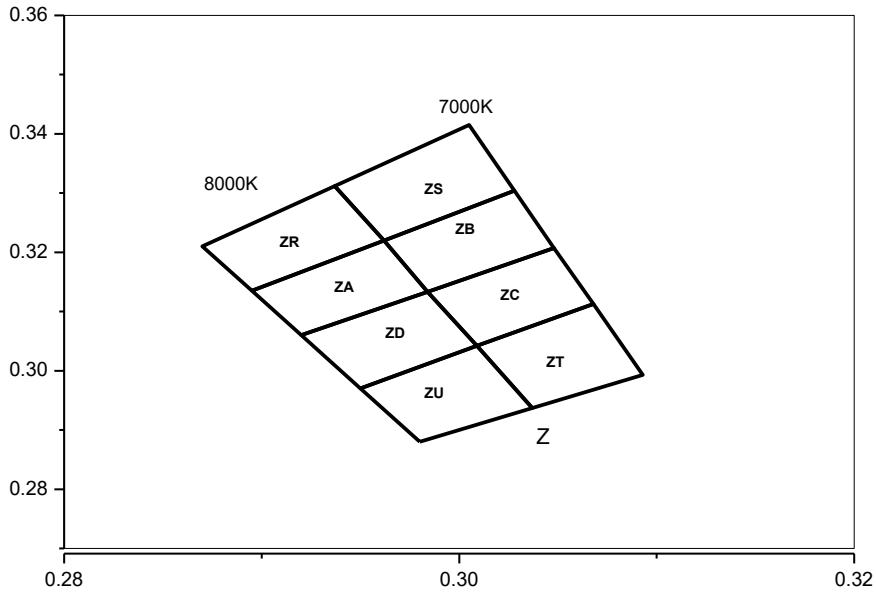

ZA		ZB		ZC		ZD	
CIE X	CIE Y	CIE X	CIE Y	CIE X	CIE Y	CIE X	CIE Y
0.2920	0.3060	0.2984	0.3133	0.2984	0.3133	0.2950	0.2970
0.2895	0.3135	0.2962	0.3220	0.3048	0.3207	0.2920	0.3060
0.2962	0.3220	0.3028	0.3304	0.3068	0.3113	0.2984	0.3133
0.2984	0.3133	0.3048	0.3207	0.3009	0.3042	0.3009	0.3042
ZR		ZS		ZT		ZU	
CIE X	CIE Y	CIE X	CIE Y	CIE X	CIE Y	CIE X	CIE Y
0.2895	0.3135	0.2962	0.3220	0.3037	0.2937	0.2980	0.2880
0.2870	0.3210	0.2937	0.3312	0.3009	0.3042	0.2950	0.2970
0.2937	0.3312	0.3005	0.3415	0.3068	0.3113	0.3009	0.3042
0.2962	0.3220	0.3028	0.3304	0.3093	0.2993	0.3037	0.2937

Color Bin Structure

CIE Chromaticity Diagram (Cool White), $T_j=85^\circ\text{C}$, $I_F=700\text{mA}$

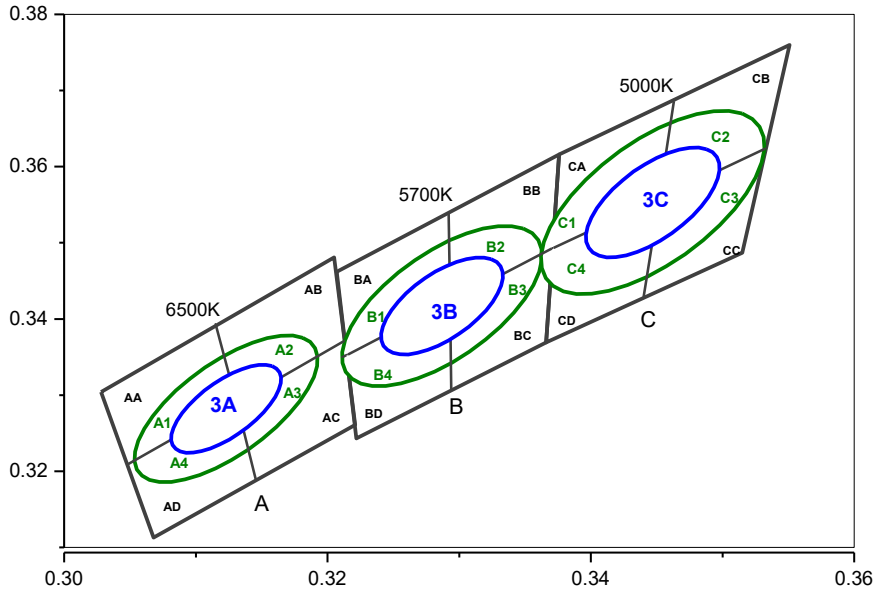

6500K 3Step		5700K 3Step		5000K 3Step			
3A		3B		3C			
Center point	0.3123 : 0.3282	Center point	0.3287 : 0.3417	Center point	0.3447 : 0.3553		
Major Axis a	0.0066	Major Axis a	0.0072	Major Axis a	0.0081		
Minor Axis b	0.0027	Minor Axis b	0.0032	Minor Axis b	0.0035		
Ellipse Rotation Angle	58	Ellipse Rotation Angle	59	Ellipse Rotation Angle	60		
6500K 5Step		5700K 5Step		5000K 5Step			
5A		5B		5C			
Center point	0.3123 : 0.3282	Center point	0.3287 : 0.3417	Center point	0.3447 : 0.3553		
Major Axis a	0.0110	Major Axis a	0.0119	Major Axis a	0.0135		
Minor Axis b	0.0045	Minor Axis b	0.0052	Minor Axis b	0.0059		
Ellipse Rotation Angle	58	Ellipse Rotation Angle	59	Ellipse Rotation Angle	60		
AA		AB		AC		AD	
CIE X	CIE Y	CIE X	CIE Y	CIE X	CIE Y	CIE X	CIE Y
0.3028	0.3304	0.3115	0.3393	0.3131	0.3290	0.3048	0.3209
0.3048	0.3209	0.3131	0.3290	0.3146	0.3187	0.3068	0.3113
0.3131	0.329	0.3213	0.3371	0.3221	0.3261	0.3146	0.3187
0.3115	0.3393	0.3205	0.3481	0.3213	0.3371	0.3131	0.329
BA		BB		BC		BD	
CIE X	CIE Y	CIE X	CIE Y	CIE X	CIE Y	CIE X	CIE Y
0.3207	0.3462	0.3292	0.3539	0.3293	0.3423	0.3215	0.3353
0.3215	0.3353	0.3293	0.3423	0.3294	0.3306	0.3222	0.3243
0.3293	0.3423	0.3371	0.3493	0.3366	0.3369	0.3294	0.3306
0.3292	0.3539	0.3376	0.3616	0.3371	0.3493	0.3293	0.3423
CA		CB		CC		CD	
CIE X	CIE Y	CIE X	CIE Y	CIE X	CIE Y	CIE X	CIE Y
0.3376	0.3616	0.3463	0.3687	0.3452	0.3558	0.3371	0.3493
0.3371	0.3493	0.3452	0.3558	0.344	0.3428	0.3366	0.3369
0.3452	0.3558	0.3533	0.3624	0.3514	0.3487	0.344	0.3428
0.3463	0.3687	0.3551	0.376	0.3533	0.3624	0.3452	0.3558

Color Bin Structure

CIE Chromaticity Diagram (Neutral White), $T_j=85^\circ\text{C}$, $I_f=700\text{mA}$

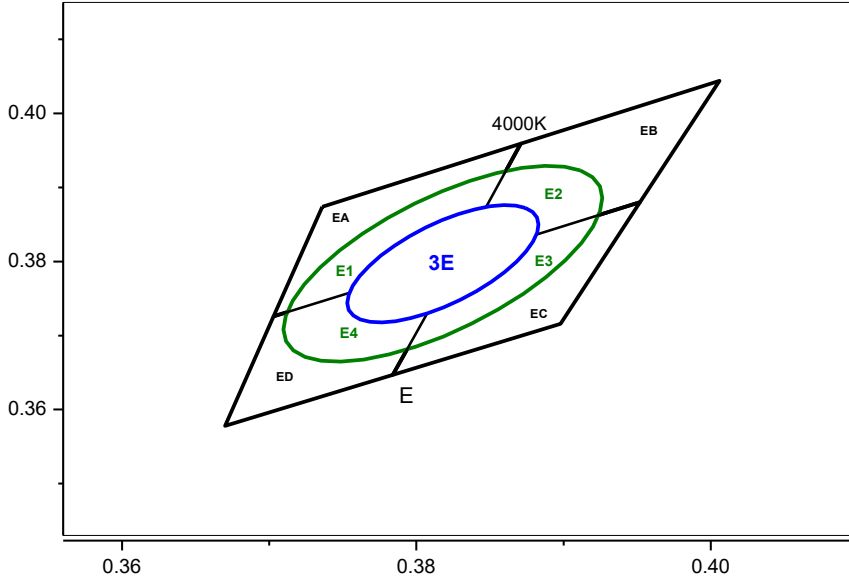

4000K 3Step

3E	
Center point	0.3818 : 0.3797
Major Axis a	0.0094
Minor Axis b	0.0041
Ellipse	53.4
Rotation Angle	

4000K 5Step

5E	
Center point	0.3818 : 0.3797
Major Axis a	0.0157
Minor Axis b	0.0067
Ellipse	53
Rotation Angle	

EA		EB		EC		ED	
CIE X	CIE Y	CIE X	CIE Y	CIE X	CIE Y	CIE X	CIE Y
0.3736	0.3874	0.3871	0.3959	0.3828	0.3803	0.3703	0.3726
0.3703	0.3726	0.3828	0.3803	0.3784	0.3647	0.3670	0.3578
0.3828	0.3803	0.3952	0.3880	0.3898	0.3716	0.3784	0.3647
0.3871	0.3959	0.4006	0.4044	0.3952	0.3880	0.3828	0.3803

Color Bin Structure

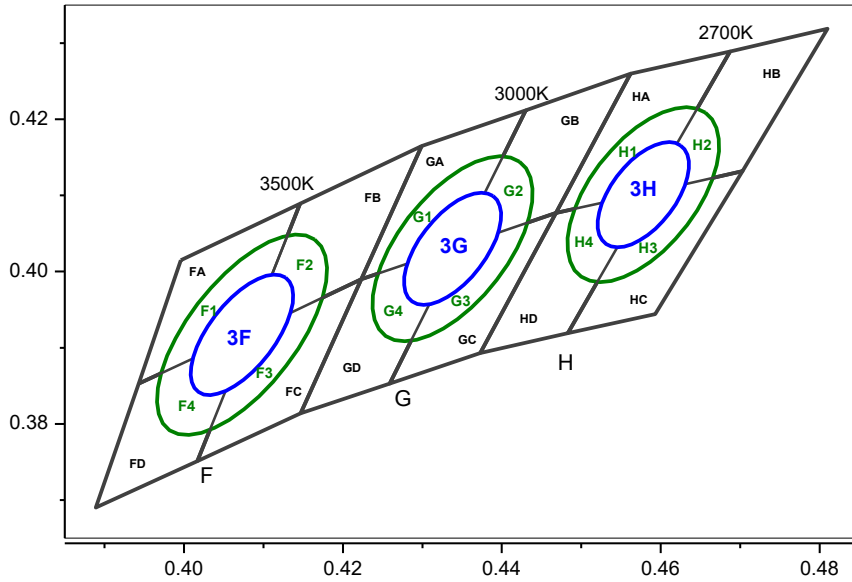
CIE Chromaticity Diagram (Warm White), $T_j=85^\circ\text{C}$, $I_f=700\text{mA}$

3500K 3Step				3000K 3Step				2700K 3Step			
3F				3G				3H			
Center point		0.4073 : 0.3917		Center point		0.4338 : 0.4030		Center point		0.4578 : 0.4101	
Major Axis a		0.0093		Major Axis a		0.0086		Major Axis a		0.0080	
Minor Axis b		0.0042		Minor Axis b		0.0042		Minor Axis b		0.0041	
Ellipse Rotation Angle		54		Ellipse Rotation Angle		54		Ellipse Rotation Angle		54	
3500K 5Step				3000K 5Step				2700K 5Step			
5F				5G				5H			
Center point		0.4073 : 0.3917		Center point		0.4338 : 0.4030		Center point		0.4578 : 0.4101	
Major Axis a		0.0155		Major Axis a		0.0142		Major Axis a		0.0132	
Minor Axis b		0.0068		Minor Axis b		0.0068		Minor Axis b		0.0068	
Ellipse Rotation Angle		54		Ellipse Rotation Angle		54		Ellipse Rotation Angle		54	
FA		FB		FC		FD					
CIE X	CIE Y	CIE X	CIE Y	CIE X	CIE Y	CIE X	CIE Y				
0.3996	0.4015	0.4146	0.4089	0.4082	0.3920	0.3943	0.3853				
0.3943	0.3853	0.4082	0.3920	0.4017	0.3751	0.3889	0.3690				
0.4082	0.392	0.4223	0.3990	0.4147	0.3814	0.4017	0.3751				
0.4146	0.4089	0.4299	0.4165	0.4223	0.3990	0.4082	0.3920				
GA		GB		GC		GD					
CIE X	CIE Y	CIE X	CIE Y	CIE X	CIE Y	CIE X	CIE Y				
0.4299	0.4165	0.4430	0.4212	0.4345	0.4033	0.4223	0.399				
0.4223	0.3990	0.4345	0.4033	0.4259	0.3853	0.4147	0.3814				
0.4345	0.4033	0.4468	0.4077	0.4373	0.3893	0.4259	0.3853				
0.4430	0.4212	0.4562	0.426	0.4468	0.4077	0.4345	0.4033				
HA		HB		HC		HD					
CIE X	CIE Y	CIE X	CIE Y	CIE X	CIE Y	CIE X	CIE Y				
0.4562	0.426	0.4687	0.4289	0.4585	0.4104	0.4468	0.4077				
0.4468	0.4077	0.4585	0.4104	0.4483	0.3919	0.4373	0.3893				
0.4585	0.4104	0.4703	0.4132	0.4593	0.3944	0.4483	0.3919				
0.4687	0.4289	0.481	0.4319	0.4703	0.4132	0.4585	0.4104				

Color Bin Structure

CIE Chromaticity Diagram (Soft Warm White), $T_j=85^\circ\text{C}$, $I_f=700\text{mA}$

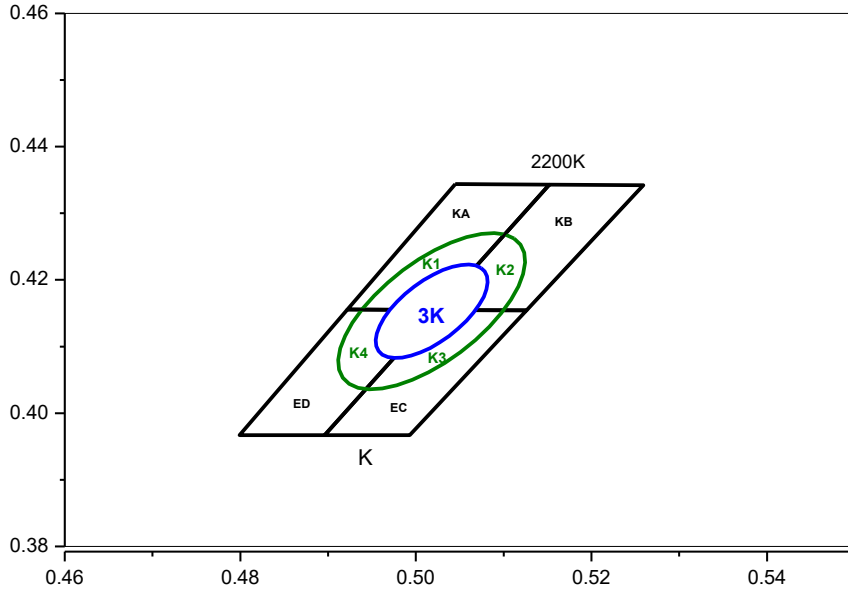

2200K 3Step

3K	
Center point	0.5018 : 0.4153
Major Axis a	0.0086
Minor Axis b	0.0040
Ellipse Rotation Angle	49.3

2200K 5Step

5K	
Center point	0.5018 : 0.4153
Major Axis a	0.0144
Minor Axis b	0.0066
Ellipse Rotation Angle	49.3

KA		KB		KC		KD	
CIE X	CIE Y	CIE X	CIE Y	CIE X	CIE Y	CIE X	CIE Y
0.5045	0.4344	0.5152	0.4343	0.5024	0.4155	0.4922	0.4156
0.4922	0.4156	0.5024	0.4155	0.4896	0.3967	0.4799	0.3967
0.5024	0.4155	0.5126	0.4155	0.4993	0.3967	0.4896	0.3967
0.5152	0.4343	0.5259	0.4342	0.5126	0.4155	0.5024	0.4155

Mechanical Dimensions

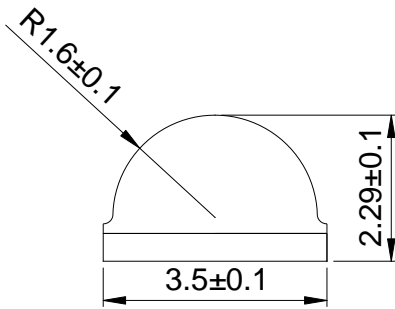
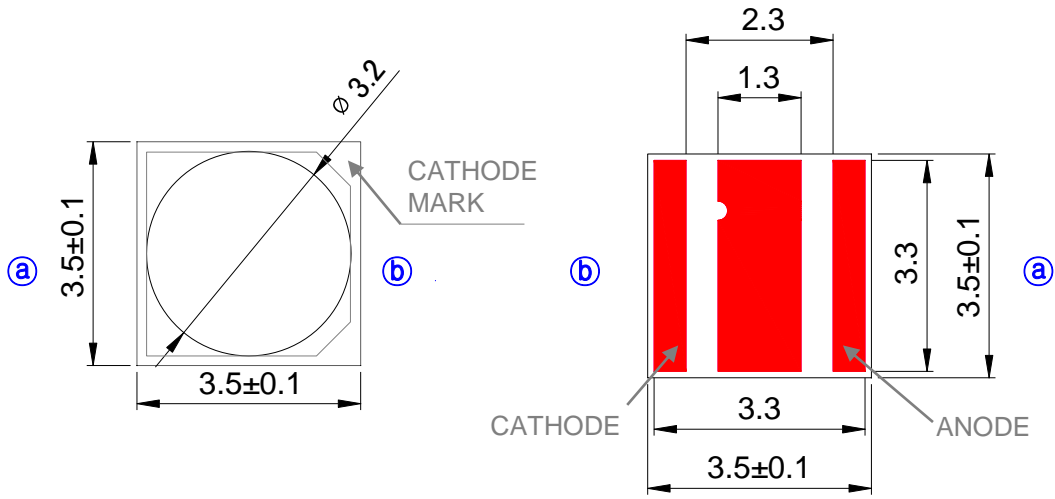

Circuit

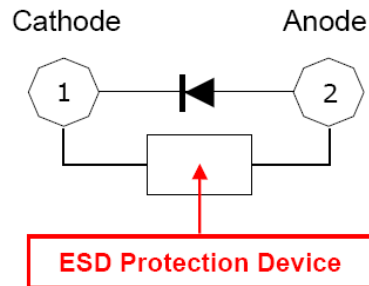

- (1) All dimensions are in millimeters.
- (2) Scale : none
- (3) Undefined tolerance is ± 0.1 mm

Recommended Solder Pad

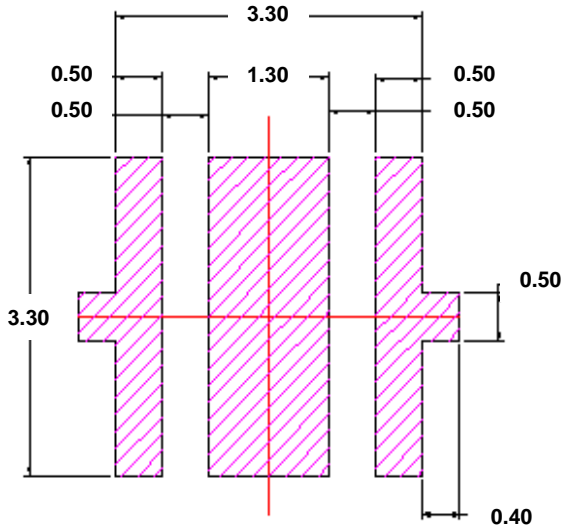

Recommended PCB Solder Pad

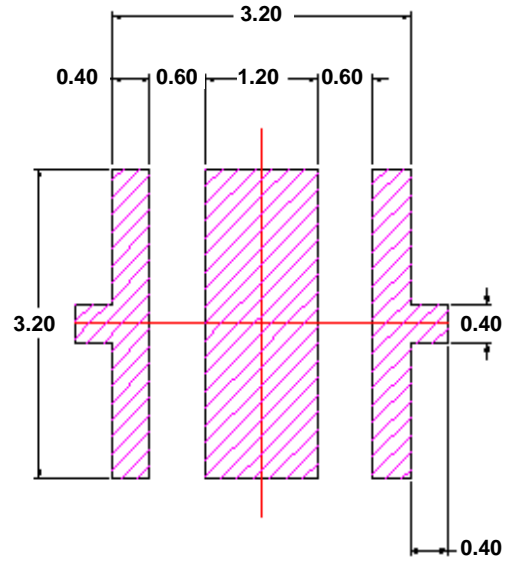

Recommended Stencil Pattern

- (1) All dimensions are in millimeters.
- (2) Scale : none
- (3) This drawing without tolerances are for reference only.
- (4) Undefined tolerance is $\pm 0.1\text{mm}$.

Reflow Soldering Characteristics

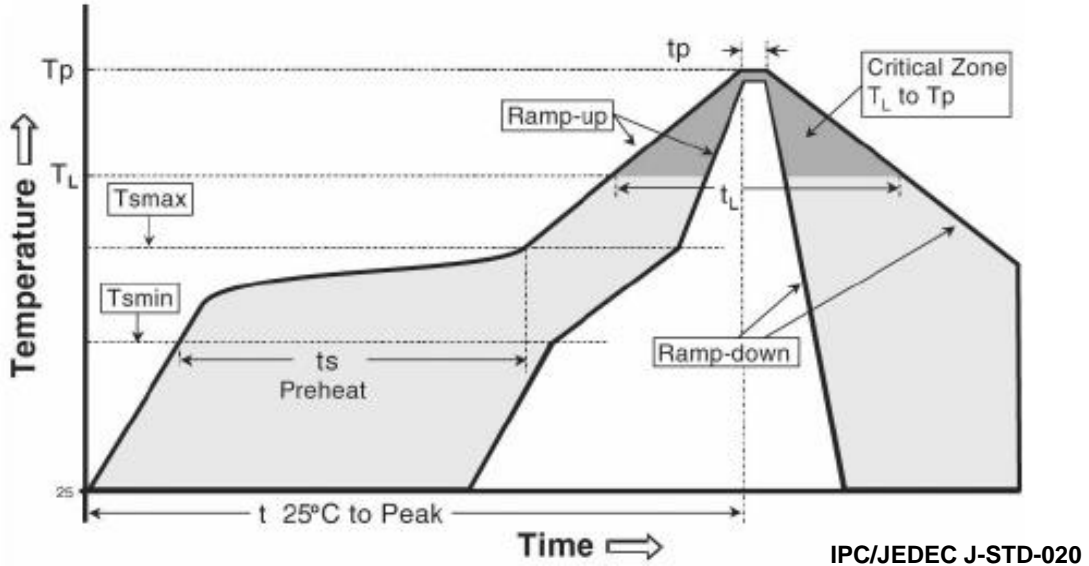

Profile Feature	Sn-Pb Eutectic Assembly	Pb-Free Assembly
Average ramp-up rate (T _{smax} to T _p)	3° C/second max.	3° C/second max.
Preheat - Temperature Min (T _{smin}) - Temperature Max (T _{smax}) - Time (T _{smin} to T _{smax}) (t _s)	100 °C 150 °C 60-120 seconds	150 °C 200 °C 60-180 seconds
Time maintained above: - Temperature (T _L) - Time (t _L)	183 °C 60-150 seconds	217 °C 60-150 seconds
Peak Temperature (T _p)	215°C	260°C
Time within 5°C of actual Peak Temperature (t _p) ²	10-30 seconds	20-40 seconds
Ramp-down Rate	6 °C/second max.	6 °C/second max.
Time 25°C to Peak Temperature	6 minutes max.	8 minutes max.

Caution

- (1) Reflow soldering is recommended not to be done more than two times. In the case of more than 24 hours passed soldering after first, LEDs will be damaged.
- (2) Repairs should not be done after the LEDs have been soldered. When repair is unavoidable, suitable tools must be used.
- (3) Die slug is to be soldered.
- (4) When soldering, do not put stress on the LEDs during heating.
- (5) After soldering, do not warp the circuit board.

Emitter Tape & Reel Packaging

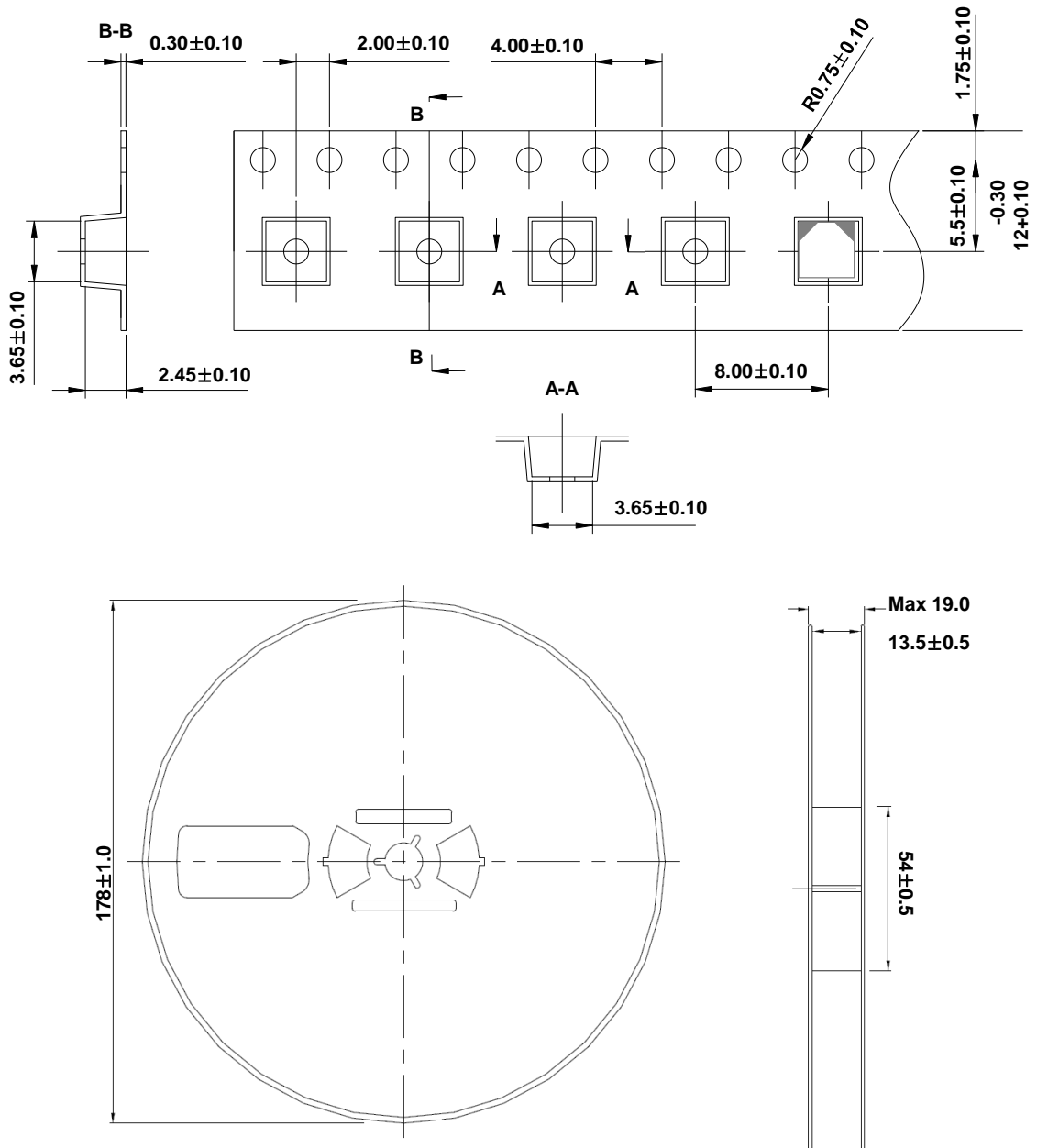
Notes :

UNIT: mm

1. Quantity : 900pcs/Reel
2. Cumulative Tolerance : Cumulative Tolerance/10 pitches to be ± 0.2 mm
3. Adhesion Strength of Cover Tape : Adhesion strength to be 10-60g when the cover tape is turned off from the carrier tape at the angle of 10° to the carrier tape
4. Package : P/N, Manufacturing data Code No. and quantity to be indicated on a damp proof Package

Packaging Information

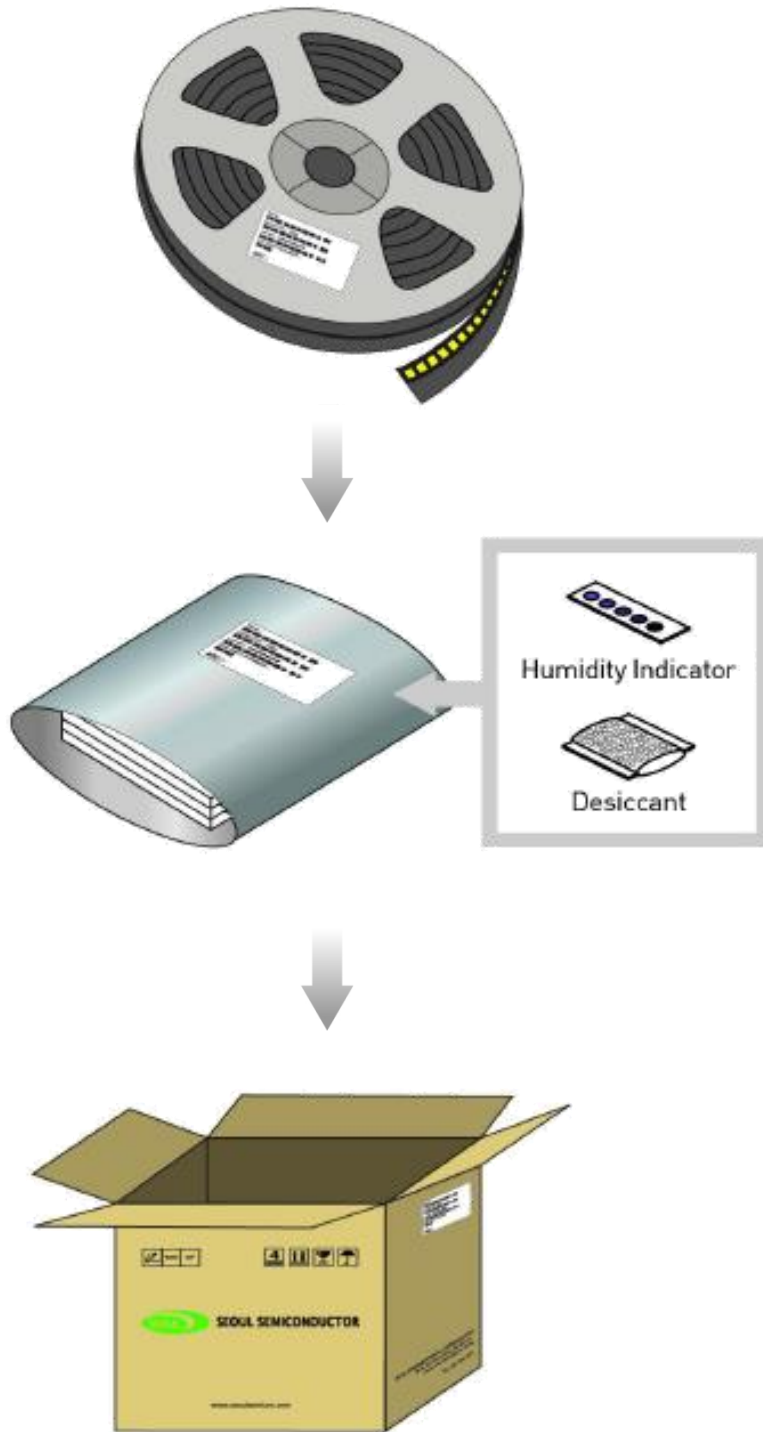

Order Code Nomenclature

Table 9. Order Code example

S 1 W 0 - 3 5 3 5 4 0 7 0 0 3 - 0 0 0 0 0 0 0 0 - 0 0 0 0 4
 X₁ X₂ X₃ X₄ X₅ X₆ X₇ X₈ X₉ X₁₀ X₁₁ X₁₂ X₁₃ X₁₄ X₁₅ X₁₆ X₁₇ X₁₈ X₁₉ X₂₀ X₂₁ X₂₂ X₂₃ X₂₄ X₂₅ X₂₆ X₂₇ X₂₈ X₂₉ X₃₀

Code digits	Value	References	Description
X ₁	S	Seoul Semiconductor	
X ₂	1	Discrete LED	
X ₃ X ₄	W0	General White	
X ₅	-		
X ₆ X ₇ X ₈ X ₉	3535	PKG size	
X ₁₀ X ₁₁	40	CCT	27= 2700K, 30=3000K, 40=4000K, 50=5000K, 56=5600K, 65=6500K
X ₁₂ X ₁₃	70	CRI	70=70CRI, 80= 80CRI, 90=90CRI
X ₁₄ X ₁₅	03	Voltage	
X ₁₆	-		
X ₁₇ X ₁₈ X ₁₉	000	Flux Rank	000=Full
X ₂₀ X ₂₁ X ₂₂	000	Vf Rank	000=Full
X ₂₃ X ₂₄	00	CIE Rank	3S=3step ellipse, 5S=5step ellipse, 00=Full
X ₂₅	-		
X ₂₆ X ₂₇	00	Type	
X ₂₈ X ₂₉ X ₃₀	004	Z5M4	PKG type internal code

Handling of Silicone Resin for LEDs

- (1) During processing, mechanical stress on the surface should be minimized as much as possible. Sharp objects of all types should not be used to pierce the sealing compound.

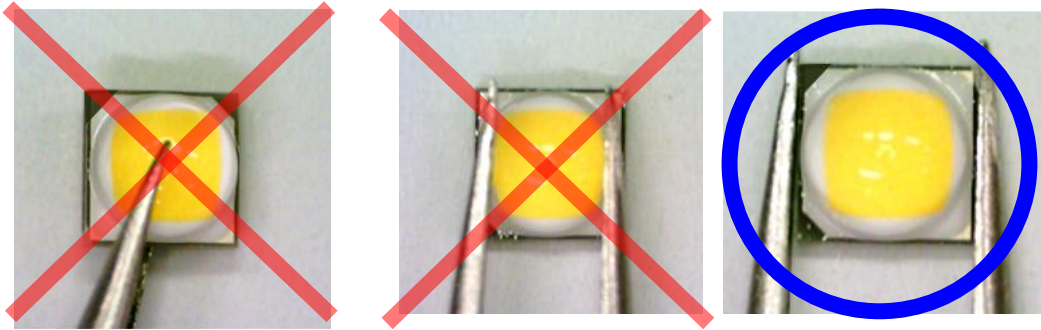

- (2) In general, LED should only be handled from the side. By the way, this also applies to LED without a silicone sealant, since the surface can also become scratched.
- (3) When populating boards in SMT production, there are basically no restrictions regarding the form of the pick and place nozzle, except that mechanical pressure on the surface of the resin must be prevented. This is assured by choosing a pick and place nozzle which is larger than the LED's reflector area.
- (4) Silicone differs from materials conventionally used for the manufacturing of LEDs. These conditions must be considered during the handling of such devices. Compared to standard encapsulants, silicone is generally softer, and the surface is more likely to attract dust. As mentioned previously, the increased sensitivity to dust requires special care during processing. In cases where a minimal level of dirt and dust particles cannot be guaranteed, a suitable cleaning solution must be applied to the surface after the soldering of components.
- (5) Seoul Semiconductor suggests using isopropyl alcohol for cleaning. In case other solvents are used, it must be assured that these solvents do not dissolve the package or resin. Ultrasonic cleaning is not recommended. Ultrasonic cleaning may cause damage to the LED.
- (6) Please do not mold this product into another resin (epoxy, urethane, etc) and do not handle this product with acid or sulfur material in sealed space.
- (7) Avoid leaving fingerprints on silicone resin parts.

Precaution for Use

(1) Storage

To avoid the moisture penetration, we recommend storing LED in a dry box with a desiccant . The recommended storage temperature range is 5°C to 30°C and a maximum humidity of RH50%.

(2) Use Precaution after Opening the Packaging

Use SMD techniques properly when solder the LED as separation of the lens may affect the light output efficiency.

Pay attention to the following:

a. Recommend conditions after opening the package

- Sealing / Temperature : 5 ~ 30°C Humidity : less than RH60%

b. If the package has been opened more than 4 weeks (**MSL 2a**) or the color of the desiccant changes, components should be dried for 10-24hr at 65±5°C

(3) Do not apply mechanical force or excess vibration during the cooling process to normal temperature after soldering.

(4) Do not rapidly cool device after soldering.

(5) Components should not be mounted on warped (non coplanar) portion of PCB.

(6) Radioactive exposure is not considered for the products listed here in.

(7) Gallium arsenide is used in some of the products listed in this publication. These products are dangerous if they are burned or shredded in the process of disposal. It is also dangerous to drink the liquid or inhale the gas generated by such products when chemically disposed of.

(8) This device should not be used in any type of fluid such as water, oil, organic solvent and etc. When washing is required, IPA (Isopropyl Alcohol) should be used.

(9) When the LED are in operation the maximum current should be decided after measuring the package temperature.

(10) The appearance and specifications of the product may be modified for improvement without notice.

(11) Long time exposure of sunlight or occasional UV exposure will cause lens discoloration.

Precaution for Use

(12) VOCs (Volatile organic compounds) emitted from materials used in the construction of fixtures can penetrate silicone encapsulants of LED and discolor when exposed to heat and photonic energy. The result can be a significant loss of light output from the fixture. Knowledge of the properties of the materials selected to be used in the construction of fixtures can help prevent these issues.

(13) Attaching LEDs, do not use adhesives that outgas organic vapor.

(14) The driving circuit must be designed to allow forward voltage only when it is ON or OFF. If the reverse voltage is applied to LED, migration can be generated resulting in LED damage.

(15) LED is sensitive to Electro-Static Discharge (ESD) and Electrical Over Stress (EOS). Below is a list of suggestions that Seoul Semiconductor purposes to minimize these effects.

a. ESD (Electro Static Discharge)

Electrostatic discharge (ESD) is defined as the release of static electricity when two objects come into contact. While most ESD events are considered harmless, it can be an expensive problem in many industrial environments during production and storage. The damage from ESD to an LED may cause the product to demonstrate unusual characteristics such as:

- Increase in reverse leakage current lowered turn-on voltage
- Abnormal emissions from the LED at low current

The following recommendations are suggested to help minimize the potential for an ESD event.

One or more recommended work area suggestions:

- Ionizing fan setup
- ESD table/shelf mat made of conductive materials
- ESD safe storage containers

One or more personnel suggestion options:

- Antistatic wrist-strap
- Antistatic material shoes
- Antistatic clothes

Environmental controls:

- Humidity control (ESD gets worse in a dry environment)

Precaution for Use

b. EOS (Electrical Over Stress)

Electrical Over-Stress (EOS) is defined as damage that may occur when an electronic device is subjected to a current or voltage that is beyond the maximum specification limits of the device. The effects from an EOS event can be noticed through product performance like:

- Changes to the performance of the LED package
(If the damage is around the bond pad area and since the package is completely encapsulated the package may turn on but flicker show severe performance degradation.)
- Changes to the light output of the luminaire from component failure
- Components on the board not operating at determined drive power

Failure of performance from entire fixture due to changes in circuit voltage and current across total circuit causing trickle down failures. It is impossible to predict the failure mode of every LED exposed to electrical overstress as the failure modes have been investigated to vary, but there are some common signs that will indicate an EOS event has occurred:

- Damaged may be noticed to the bond wires (appearing similar to a blown fuse)
- Damage to the bond pads located on the emission surface of the LED package
(shadowing can be noticed around the bond pads while viewing through a microscope)
- Anomalies noticed in the encapsulation and phosphor around the bond wires.
- This damage usually appears due to the thermal stress produced during the EOS event.

c. To help minimize the damage from an EOS event Seoul Semiconductor recommends utilizing:

- A surge protection circuit
- An appropriately rated over voltage protection device
- A current limiting device



Company Information

Published by

Seoul Semiconductor © 2013 All Rights Reserved.

Company Information

Seoul Semiconductor (www.SeoulSemicon.com) manufactures and packages a wide selection of light emitting diodes (LEDs) for the automotive, general illumination/lighting, Home appliance, signage and back lighting markets. The company is the world's fifth largest LED supplier, holding more than 10,000 patents globally, while offering a wide range of LED technology and production capacity in areas such as "nPola", "Acrich", the world's first commercially produced AC LED, and "Acrich MJT - Multi-Junction Technology" a proprietary family of high-voltage LEDs.

The company's broad product portfolio includes a wide array of package and device choices such as Acrich and Acirch2, high-brightness LEDs, mid-power LEDs, side-view LEDs, and through-hole type LEDs as well as custom modules, displays, and sensors.

Legal Disclaimer

Information in this document is provided in connection with Seoul Semiconductor products. With respect to any examples or hints given herein, any typical values stated herein and/or any information regarding the application of the device, Seoul Semiconductor hereby disclaims any and all warranties and liabilities of any kind, including without limitation, warranties of non-infringement of intellectual property rights of any third party. The appearance and specifications of the product can be changed to improve the quality and/or performance without notice.