

XLamp® XHP70.3 LEDs

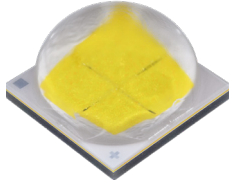

XHP70.3 High Density

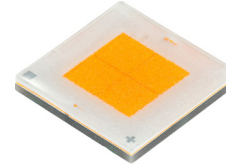

XHP70.3 High Intensity

PRODUCT DESCRIPTION

The XLamp® XHP70.3 LEDs are the third generation of Extreme High Power LEDs that deliver the best lumen density, reliability and optical control available in their size. By leveraging the XHP family advantages, lighting manufacturers can significantly reduce their system cost by using fewer optics, PCBs and heat sinks than possible with standard LEDs.

The third generation XHP family LEDs deliver improved optical performance versus the previous generations, with higher intensity through optics than the second generation and the XHP family's highest on-axis intensity.

XLamp XHP70.3 LEDs are optimized for outdoor and premium indoor lighting applications that require large amounts of light output from small luminaires, such as stadium, outdoor area and architectural spotlight.

FEATURES

- Available in white, configurable to 6 V or 12 V by PCB layout
- Available in 5-step EasyWhite® bins at 3000 K to 5000 K CCT, 3-step EasyWhite bins at 2700 K to 5000 K and 2-step EasyWhite bins at 2700 K to 4000 K CCT
- Available in ANSI white bins at 3000 K to 7000 K CCT
- Broadcast color option at 5700 K provides maximum performance for TV events that require extremely high TLCI
- Available in standard, 70-, 80-, 90-, and 95-minimum CRI options
- Binned at 85 °C
- Maximum drive current: 7200 mA (6 V), 3600 mA (12 V)
- Low thermal resistance: 0.2 °C/W
- Wide viewing angle: 120° (HD), 115 (HI)
- Unlimited floor life at ≤ 30 °C/85% RH
- Reflow solderable - JEDEC J-STD-020C
- RoHS and REACH compliant
- UL® recognized component (E349212)



TABLE OF CONTENTS

| | |
|--|----|
| Characteristics | 3 |
| Flux Characteristics, High Density EasyWhite® Order Codes and Bins | 4 |
| Flux Characteristics, High Density ANSI White Order Codes and Bins..... | 7 |
| Flux Characteristics, High Density Broadcast Order Codes and Bins..... | 10 |
| Flux Characteristics, High Intensity EasyWhite® Order Codes and Bins..... | 11 |
| Flux Characteristics, High Intensity ANSI White Order Codes and Bins..... | 14 |
| Flux Characteristics, High Intensity Broadcast Order Codes and Bins..... | 16 |
| Relative Spectral Power Distribution | 17 |
| Relative Flux vs. Junction Temperature..... | 17 |
| Electrical Characteristics..... | 18 |
| Relative Flux vs. Current | 19 |
| Relative Chromaticity vs Current (Warm White) | 20 |
| Relative Chromaticity vs Temperature (Warm White)..... | 21 |
| Typical Spatial Distribution..... | 21 |
| Thermal Design | 22 |
| Performance Groups - Luminous Flux..... | 23 |
| Performance Groups - Chromaticity | 23 |
| EasyWhite® Chromaticity Regions Plotted on the 1931 CIE Curve..... | 27 |
| ANSI Standard Cool White Kits Plotted on ANSI Standard Chromaticity Regions | 28 |
| Standard Warm and Neutral White Kits Plotted on ANSI Standard Chromaticity Regions | 29 |
| Bin and Order-Code Format..... | 30 |
| Reflow Soldering Characteristics..... | 31 |
| Notes | 32 |
| Mechanical Dimensions | 34 |
| Electrical Configuration | 36 |
| Tape and Reel..... | 37 |
| Packaging..... | 39 |

CHARACTERISTICS

XHP70.3 LEDs are tested and binned in the 12-V configuration. See the Mechanical Dimensions section on page 34 for pad layout options.

| Characteristics | Unit | Minimum | Typical | Maximum |
|---|---------|---------|----------|---------|
| Thermal resistance, junction to solder point ^o | °C/W | | 0.2 | |
| Viewing angle (FWHM) - High Density | degrees | | 120 | |
| Viewing angle (FWHM) - High Intensity | degrees | | 115 | |
| Temperature coefficient of voltage (6 V)* | mV/°C | | -2.5 | |
| Temperature coefficient of voltage (12 V) | mV/°C | | -5.0 | |
| ESD withstand voltage (HBM per Mil-Std-883D) | | | Class 3B | |
| DC forward current (6 V)* | mA | | | 7200 |
| DC forward current (12 V) | mA | | | 3600 |
| Reverse voltage | V | | | 1 |
| Forward voltage (6 V, @ 2100 mA, 85 °C)* | V | | 5.6 | 6.1 |
| Forward voltage (12 V, @ 1050 mA, 85 °C) | V | | 11.2 | 12.2 |
| LED junction temperature | °C | | | 150 |

Note:

- ◊ Thermal resistance measurement was performed per the JEDEC JESD51-14 standard. See the [Thermal Resistance Measurement application note](#) for more details.
- * Data for the 6-V configuration is calculated and for reference only.

FLUX CHARACTERISTICS, HIGH DENSITY EASYWHITE® ORDER CODES AND BINS

The following table provides order codes for XLamp XHP70.3 High Density LEDs. For a complete description of how the flux and chromaticity groups are reflected in the bin code and order code nomenclature, please see the Bin and Order Code Formats section (page 30).

Binning condition: $T_j = 85\text{ °C}$; 12 V, $I_f = 1050\text{ mA}$
 Reference condition: $T_j = 85\text{ °C}$; 6 V, $I_f = 2100\text{ mA}$

| Nominal CCT | CRI | | Minimum Luminous Flux | | | 2-Step | | 3-Step | | 5-Step | |
|-------------|-----|-----|-----------------------|-------------------|--------------------|--------|------------|--------|--------------------------|--------|--------------------------|
| | Min | Typ | Group | Flux (lm) @ 85 °C | Flux (lm) @ 25 °C* | Group | Order Code | Group | Order Code | Group | Order Code |
| 5000 K | 70 | | P4 | 1965 | 2164 | | | | | 50E | XHP70D-00-0000-0D0BP450E |
| | | | P2 | 1830 | 2015 | | | | | | XHP70D-00-0000-0D0BP250E |
| | | | N4 | 1710 | 1883 | | | | | | XHP70D-00-0000-0D0BN450E |
| | 80 | | P2 | 1830 | 2015 | | | 50G | XHP70D-00-0000-0D0HP250G | | |
| | | | N4 | 1710 | 1883 | | | | XHP70D-00-0000-0D0HN450G | | |
| | | | N2 | 1590 | 1751 | | | | XHP70D-00-0000-0D0HN250G | | |
| | | | M4 | 1485 | 1635 | | | | XHP70D-00-0000-0D0HM450G | | |
| | 90 | | N2 | 1590 | 1751 | | | 50G | XHP70D-00-0000-0D0UN250G | | |
| | | | M4 | 1485 | 1635 | | | | XHP70D-00-0000-0D0UM450G | | |
| | | | M2 | 1380 | 1520 | | | | XHP70D-00-0000-0D0UM250G | | |

- Notes
- Cree LED maintains a tolerance of ±7% on flux and power measurements, ±0.005 on chromaticity (CCx, CCy) measurements and a tolerance of ±2 on CRI measurements. See the Measurements section (page 32).
 - XLamp XHP70.3 LED order codes specify only a minimum flux bin and not a maximum. Cree LED may ship reels in flux bins higher than the minimum specified by the order code without advance notice. Shipments will always adhere to the chromaticity bin restrictions specified by the order code.
 - Flux values @ 25 °C are calculated and for reference only.

FLUX CHARACTERISTICS, HIGH DENSITY EASYWHITE® ORDER CODES AND BINS - CONTINUED

| Nominal CCT | CRI | | Minimum Luminous Flux | | | 2-Step | | 3-Step | | 5-Step | |
|-------------|-----|-----|-----------------------|-------------------|--------------------|--------|--------------------------|--------|--------------------------|--------|--------------------------|
| | Min | Typ | Group | Flux (lm) @ 85 °C | Flux (lm) @ 25 °C* | Group | Order Code | Group | Order Code | Group | Order Code |
| 4500 K | 70 | | P4 | 1965 | 2164 | | | | | 45E | XHP70D-00-0000-0D0BP445E |
| | | | P2 | 1830 | 2015 | | XHP70D-00-0000-0D0BP245E | | | | |
| | | | N4 | 1710 | 1883 | | XHP70D-00-0000-0D0BN445E | | | | |
| | 80 | | N4 | 1710 | 1883 | | | 45G | XHP70D-00-0000-0D0HN445G | | |
| | | | N2 | 1590 | 1751 | | XHP70D-00-0000-0D0HN245G | | | | |
| | | | M4 | 1485 | 1635 | | XHP70D-00-0000-0D0HM445G | | | | |
| | 90 | | M4 | 1485 | 1635 | | | 45G | XHP70D-00-0000-0D0UM445G | | |
| | | | M2 | 1380 | 1520 | | XHP70D-00-0000-0D0UM245G | | | | |
| | | | K4 | 1290 | 1420 | | XHP70D-00-0000-0D0UK445G | | | | |
| 4000 K | 70 | | P4 | 1965 | 2164 | | | | | 40E | XHP70D-00-0000-0D0BP440E |
| | | | P2 | 1830 | 2015 | | XHP70D-00-0000-0D0BP240E | | | | |
| | | | N4 | 1710 | 1883 | | XHP70D-00-0000-0D0BN440E | | | | |
| | 80 | | N4 | 1710 | 1883 | 40H | XHP70D-00-0000-0D0HN440H | 40G | XHP70D-00-0000-0D0HN440G | | |
| | | | N2 | 1590 | 1751 | | XHP70D-00-0000-0D0HN240H | | XHP70D-00-0000-0D0HN240G | | |
| | | | M4 | 1485 | 1635 | | XHP70D-00-0000-0D0HM440H | | XHP70D-00-0000-0D0HM440G | | |
| | 90 | | M4 | 1485 | 1635 | 40H | XHP70D-00-0000-0D0UM440H | 40G | XHP70D-00-0000-0D0UM440G | | |
| | | | M2 | 1380 | 1520 | | XHP70D-00-0000-0D0UM240H | | XHP70D-00-0000-0D0UM240G | | |
| | | | K4 | 1290 | 1420 | | XHP70D-00-0000-0D0UK440H | | XHP70D-00-0000-0D0UK440G | | |

- Notes**
- Cree LED maintains a tolerance of ±7% on flux and power measurements, ±0.005 on chromaticity (CCx, CCy) measurements and a tolerance of ±2 on CRI measurements. See the Measurements section (page 32).
 - XLamp XHP70.3 LED order codes specify only a minimum flux bin and not a maximum. Cree LED may ship reels in flux bins higher than the minimum specified by the order code without advance notice. Shipments will always adhere to the chromaticity bin restrictions specified by the order code.
 - Flux values @ 25 °C are calculated and for reference only.

FLUX CHARACTERISTICS, HIGH DENSITY EASYWHITE® ORDER CODES AND BINS - CONTINUED

| Nominal CCT | CRI | | Minimum Luminous Flux | | | 2-Step | | 3-Step | | 5-Step | |
|-------------|--------|-----|-----------------------|-------------------|--------------------|--------------------------|--------------------------|--------------------------|--------------------------|--------------------------|--------------------------|
| | Min | Typ | Group | Flux (lm) @ 85 °C | Flux (lm) @ 25 °C* | Group | Order Code | Group | Order Code | Group | Order Code |
| 3500 K | 70 | | P2 | 1830 | 2015 | | | | | 35E | XHP70D-00-0000-0D0BP235E |
| | | | N4 | 1710 | 1883 | | XHP70D-00-0000-0D0BN435E | | | | |
| | | | N2 | 1590 | 1751 | | XHP70D-00-0000-0D0BN235E | | | | |
| | 80 | | N4 | 1710 | 1883 | 35H | XHP70D-00-0000-0D0HN435H | 35G | XHP70D-00-0000-0D0HN435G | | |
| | | | N2 | 1590 | 1751 | | XHP70D-00-0000-0D0HN235H | | XHP70D-00-0000-0D0HN235G | | |
| | | | M4 | 1485 | 1635 | | XHP70D-00-0000-0D0HM435H | | XHP70D-00-0000-0D0HM435G | | |
| | 90 | | M4 | 1485 | 1635 | 35H | XHP70D-00-0000-0D0UM435H | 35G | XHP70D-00-0000-0D0UM435G | | |
| | | | M2 | 1380 | 1520 | | XHP70D-00-0000-0D0UM235H | | XHP70D-00-0000-0D0UM235G | | |
| | | | K4 | 1290 | 1420 | | XHP70D-00-0000-0D0UK435H | | XHP70D-00-0000-0D0UK435G | | |
| 3000 K | 70 | | P2 | 1830 | 2015 | | | | | 30E | XHP70D-00-0000-0D0BP230E |
| | | | N4 | 1710 | 1883 | | XHP70D-00-0000-0D0BN430E | | | | |
| | | | N2 | 1590 | 1751 | | XHP70D-00-0000-0D0BN230E | | | | |
| | 80 | | N2 | 1590 | 1751 | 30H | XHP70D-00-0000-0D0HN230H | 30G | XHP70D-00-0000-0D0HN230G | | |
| | | | M4 | 1485 | 1635 | | XHP70D-00-0000-0D0HM430H | | XHP70D-00-0000-0D0HM430G | | |
| | 90 | | M2 | 1380 | 1520 | 30H | XHP70D-00-0000-0D0UM230H | 30G | XHP70D-00-0000-0D0UM230G | | |
| | | | K4 | 1290 | 1420 | | XHP70D-00-0000-0D0UK430H | | XHP70D-00-0000-0D0UK430G | | |
| | | | K2 | 1200 | 1321 | | XHP70D-00-0000-0D0UK230H | | XHP70D-00-0000-0D0UK230G | | |
| | 2700 K | 80 | | M4 | 1485 | 1635 | 27H | XHP70D-00-0000-0D0HM427H | 27G | XHP70D-00-0000-0D0HM427G | |
| M2 | | | | 1380 | 1520 | XHP70D-00-0000-0D0HM227H | | XHP70D-00-0000-0D0HM227G | | | |
| 90 | | | K4 | 1290 | 1420 | 27H | XHP70D-00-0000-0D0UK427H | 27G | XHP70D-00-0000-0D0UK427G | | |
| | | | K2 | 1200 | 1321 | | XHP70D-00-0000-0D0UK227H | | XHP70D-00-0000-0D0UK227G | | |
| | | | J4 | 1120 | 1233 | | XHP70D-00-0000-0D0UJ427H | | XHP70D-00-0000-0D0UJ427G | | |
| | | | | | | | | | | | |

- Notes**
- Cree LED maintains a tolerance of ±7% on flux and power measurements, ±0.005 on chromaticity (CCx, CCy) measurements and a tolerance of ±2 on CRI measurements. See the Measurements section (page 32).
 - XLamp XHP70.3 LED order codes specify only a minimum flux bin and not a maximum. Cree LED may ship reels in flux bins higher than the minimum specified by the order code without advance notice. Shipments will always adhere to the chromaticity bin restrictions specified by the order code.
 - Flux values @ 25 °C are calculated and for reference only.

FLUX CHARACTERISTICS, HIGH DENSITY ANSI WHITE ORDER CODES AND BINS

The following table provides order codes for XLamp XHP70.3 High Density LEDs. For a complete description of how the flux and chromaticity groups are reflected in the bin code and order code nomenclature, please see the Bin and Order Code Formats section (page 30).

Binning condition: $T_j = 85\text{ °C}$; 12 V, $I_f = 1050\text{ mA}$
 Reference condition: $T_j = 85\text{ °C}$; 6 V, $I_f = 2100\text{ mA}$

| Nominal CCT | Chromaticity Regions | CRI | | Minimum Luminous Flux | | | Order Code | |
|-------------|--|--------|----------------|-----------------------|-------------------|--------------------|--------------------------|--------------------------|
| | | Min | Typ | Group | Flux (lm) @ 85 °C | Flux (lm) @ 25 °C* | | |
| 7000 K | 0A, 0B, 0C, 0D, 0R, 0S, 0T, 0U, 1A, 1B, 1C, 1D, 1R, 1S, 1T, 1U | 0 | 68 | P2 | 1830 | 2015 | XHP70D-00-0000-0D00P20DT | |
| | | | | N4 | 1710 | 1883 | XHP70D-00-0000-0D00N40DT | |
| | | | | N2 | 1590 | 1751 | XHP70D-00-0000-0D00N20DT | |
| | | 70 | | | P2 | 1830 | 2015 | XHP70D-00-0000-0D0BP20DT |
| | | | | | N4 | 1710 | 1883 | XHP70D-00-0000-0D0BN40DT |
| | | | | | N2 | 1590 | 1751 | XHP70D-00-0000-0D0BN20DT |
| | | 80 | | | N2 | 1590 | 1751 | XHP70D-00-0000-0D0HN20DT |
| | | | | | M4 | 1485 | 1635 | XHP70D-00-0000-0D0HM40DT |
| | | 6500 K | 1A, 1B, 1C, 1D | 0 | 68 | P2 | 1830 | 2015 |
| N4 | 1710 | | | | | 1883 | XHP70D-00-0000-0D00N40E1 | |
| N2 | 1590 | | | | | 1751 | XHP70D-00-0000-0D00N20E1 | |
| 70 | | | | | P2 | 1830 | 2015 | XHP70D-00-0000-0D0BP20E1 |
| | | | | | N4 | 1710 | 1883 | XHP70D-00-0000-0D0BN40E1 |
| | | | | | N2 | 1590 | 1751 | XHP70D-00-0000-0D0BN20E1 |
| 80 | | | | | N2 | 1590 | 1751 | XHP70D-00-0000-0D0HN20E1 |
| | | | | | M4 | 1485 | 1635 | XHP70D-00-0000-0D0HM40E1 |
| 6000 K | 1A, 1B, 1C, 1D, 1R, 1S, 1T, 1U, 2A, 2B, 2C, 2D, 2R, 2S, 2T, 2U | | | 0 | 68 | P2 | 1830 | 2015 |
| | | N4 | 1710 | | | 1883 | XHP70D-00-0000-0D00N40DV | |
| | | 70 | | | P2 | 1830 | 2015 | XHP70D-00-0000-0D0BP20DV |
| | | | | | N4 | 1710 | 1883 | XHP70D-00-0000-0D0BN40DV |
| | | 80 | | | N2 | 1590 | 1751 | XHP70D-00-0000-0D0HN20DV |
| | | | | | M4 | 1485 | 1635 | XHP70D-00-0000-0D0HM40DV |
| | | 90 | | | M4 | 1485 | 1635 | XHP70D-00-0000-0D0UM40DV |
| | | | | | M2 | 1380 | 1520 | XHP70D-00-0000-0D0UM20DV |

- Notes
- Cree LED maintains a tolerance of ±7% on flux and power measurements, ±0.005 on chromaticity (CCx, CCy) measurements and a tolerance of ±2 on CRI measurements. See the Measurements section (page 32).
 - XLamp XHP70.3 LED order codes specify only a minimum flux bin and not a maximum. Cree LED may ship reels in flux bins higher than the minimum specified by the order code without advance notice. Shipments will always adhere to the chromaticity bin restrictions specified by the order code.
 - Flux values @ 25 °C are calculated and for reference only.

FLUX CHARACTERISTICS, HIGH DENSITY ANSI WHITE ORDER CODES AND BINS - CONTINUED

| Nominal CCT | Chromaticity Regions | CRI | | Minimum Luminous Flux | | | Order Code | | |
|-------------|----------------------|-----|-----|-----------------------|-------------------|--------------------|--------------------------|------|--------------------------|
| | | Min | Typ | Group | Flux (lm) @ 85 °C | Flux (lm) @ 25 °C* | | | |
| 5700 K | 2A, 2B, 2C, 2D | 0 | 68 | P4 | 1965 | 2164 | XHP70D-00-0000-0D00P40E2 | | |
| | | | | P2 | 1830 | 2015 | XHP70D-00-0000-0D00P20E2 | | |
| | | | | N4 | 1710 | 1883 | XHP70D-00-0000-0D00N40E2 | | |
| | | 70 | | | | P4 | 1965 | 2164 | XHP70D-00-0000-0D0BP40E2 |
| | | | | | | P2 | 1830 | 2015 | XHP70D-00-0000-0D0BP20E2 |
| | | | | | | N4 | 1710 | 1883 | XHP70D-00-0000-0D0BN40E2 |
| | | 80 | | | | N4 | 1710 | 1883 | XHP70D-00-0000-0D0HN40E2 |
| | | | | | | N2 | 1590 | 1751 | XHP70D-00-0000-0D0HN20E2 |
| | | | | | | M4 | 1485 | 1635 | XHP70D-00-0000-0D0HM40E2 |
| | | 90 | | | | N2 | 1590 | 1751 | XHP70D-00-0000-0D0UN20E2 |
| | | | | | | M4 | 1485 | 1635 | XHP70D-00-0000-0D0UM40E2 |
| | | | | | | M2 | 1380 | 1520 | XHP70D-00-0000-0D0UM20E2 |
| 5000 K | 3A, 3B, 3C, 3D | 0 | 68 | P4 | 1965 | 2164 | XHP70D-00-0000-0D00P40E3 | | |
| | | | | P2 | 1830 | 2015 | XHP70D-00-0000-0D00P20E3 | | |
| | | | | N4 | 1710 | 1883 | XHP70D-00-0000-0D00N40E3 | | |
| | | 70 | | | | P4 | 1965 | 2164 | XHP70D-00-0000-0D0BP40E3 |
| | | | | | | P2 | 1830 | 2015 | XHP70D-00-0000-0D0BP20E3 |
| | | | | | | N4 | 1710 | 1883 | XHP70D-00-0000-0D0BN40E3 |
| | | 80 | | | | P2 | 1830 | 2015 | XHP70D-00-0000-0D0HP20E3 |
| | | | | | | N4 | 1710 | 1883 | XHP70D-00-0000-0D0HN40E3 |
| | | | | | | N2 | 1590 | 1751 | XHP70D-00-0000-0D0HN20E3 |
| | | 90 | | | | M4 | 1485 | 1635 | XHP70D-00-0000-0D0HM40E3 |
| | | | | | | N2 | 1590 | 1751 | XHP70D-00-0000-0D0UN20E3 |
| | | | | | | M4 | 1485 | 1635 | XHP70D-00-0000-0D0UM40E3 |
| | | | | M2 | 1380 | 1520 | XHP70D-00-0000-0D0UM20E3 | | |
| | | | | | | | | | |
| | | | | | | | | | |
| 4500 K | 4A, 4B, 4C, 4D | 0 | 68 | P4 | 1965 | 2164 | XHP70D-00-0000-0D00P40E4 | | |
| | | | | P2 | 1830 | 2015 | XHP70D-00-0000-0D00P20E4 | | |
| | | | | N4 | 1710 | 1883 | XHP70D-00-0000-0D00N40E4 | | |
| | | 70 | | | | P4 | 1965 | 2164 | XHP70D-00-0000-0D0BP40E4 |
| | | | | | | P2 | 1830 | 2015 | XHP70D-00-0000-0D0BP20E4 |
| | | | | | | N4 | 1710 | 1883 | XHP70D-00-0000-0D0BN40E4 |
| | | 80 | | | | N4 | 1710 | 1883 | XHP70D-00-0000-0D0HN40E4 |
| | | | | | | N2 | 1590 | 1751 | XHP70D-00-0000-0D0HN20E4 |
| | | | | | | M4 | 1485 | 1635 | XHP70D-00-0000-0D0HM40E4 |
| | | 90 | | | | M4 | 1485 | 1635 | XHP70D-00-0000-0D0UM40E4 |
| | | | | | | M2 | 1380 | 1520 | XHP70D-00-0000-0D0UM20E4 |
| | | | | | | K4 | 1290 | 1420 | XHP70D-00-0000-0D0UK40E4 |

- Notes**
- Cree LED maintains a tolerance of ±7% on flux and power measurements, ±0.005 on chromaticity (CCx, CCy) measurements and a tolerance of ±2 on CRI measurements. See the Measurements section (page 32).
 - XLamp XHP70.3 LED order codes specify only a minimum flux bin and not a maximum. Cree LED may ship reels in flux bins higher than the minimum specified by the order code without advance notice. Shipments will always adhere to the chromaticity bin restrictions specified by the order code.
 - Flux values @ 25 °C are calculated and for reference only.

FLUX CHARACTERISTICS, HIGH DENSITY ANSI WHITE ORDER CODES AND BINS - CONTINUED

| Nominal CCT | Chromaticity Regions | CRI | | Minimum Luminous Flux | | | Order Code |
|-------------|----------------------|--------|----------------|-----------------------|-------------------|--------------------|--------------------------|
| | | Min | Typ | Group | Flux (lm) @ 85 °C | Flux (lm) @ 25 °C* | |
| 4000 K | 5A, 5B, 5C, 5D | 0 | 68 | P2 | 1830 | 2015 | XHP70D-00-0000-0D00N20E5 |
| | | | | N4 | 1710 | 1883 | XHP70D-00-0000-0D00N40E5 |
| | | 70 | | P4 | 1965 | 2164 | XHP70D-00-0000-0D0BP40E5 |
| | | | | P2 | 1830 | 2015 | XHP70D-00-0000-0D0BP20E5 |
| | | | | N4 | 1710 | 1883 | XHP70D-00-0000-0D0BN40E5 |
| | | 80 | | N4 | 1710 | 1883 | XHP70D-00-0000-0D0HN40E5 |
| | | | | N2 | 1590 | 1751 | XHP70D-00-0000-0D0HN20E5 |
| | | | | M4 | 1485 | 1635 | XHP70D-00-0000-0D0HM40E5 |
| | | 90 | | M4 | 1485 | 1635 | XHP70D-00-0000-0D0UM40E5 |
| | | | | M2 | 1380 | 1520 | XHP70D-00-0000-0D0UM20E5 |
| | | | | K4 | 1290 | 1420 | XHP70D-00-0000-0D0UK40E5 |
| | | 3500 K | 6A, 6B, 6C, 6D | 70 | | P2 | 1830 |
| N4 | 1710 | | | | | 1883 | XHP70D-00-0000-0D0BN40E6 |
| N2 | 1590 | | | | | 1751 | XHP70D-00-0000-0D0BN20E6 |
| 3000 K | 7A, 7B, 7C, 7D | 70 | | N4 | 1710 | 1883 | XHP70D-00-0000-0D0BN40E7 |
| | | | | N2 | 1590 | 1751 | XHP70D-00-0000-0D0BN20E7 |

- Notes**
- Cree LED maintains a tolerance of ±7% on flux and power measurements, ±0.005 on chromaticity (CCx, CCy) measurements and a tolerance of ±2 on CRI measurements. See the Measurements section (page 32).
 - XLamp XHP70.3 LED order codes specify only a minimum flux bin and not a maximum. Cree LED may ship reels in flux bins higher than the minimum specified by the order code without advance notice. Shipments will always adhere to the chromaticity bin restrictions specified by the order code.
 - Flux values @ 25 °C are calculated and for reference only.

FLUX CHARACTERISTICS, HIGH DENSITY BROADCAST ORDER CODES AND BINS

The following table provides order codes for XLamp XHP70.3 High Density Broadcast LEDs. For a complete description of how the flux and chromaticity groups are reflected in the bin code and order code nomenclature, please see the Bin and Order Code Formats section (page 30).

Binning condition: $T_j = 85\text{ °C}$; 12 V, $I_f = 1050\text{ mA}$

Reference condition: $T_j = 85\text{ °C}$; 6 V, $I_f = 2100\text{ mA}$

| Chromaticity | | Minimum Luminous Flux (lm) @ 1050 mA | | | Order Codes | |
|--------------|--------|---|----------------------|-----------------------|-----------------------------------|-----------------------------------|
| Kit | CCT | Flux Bin | Flux (lm) @ 85 °C | Flux (lm) @ 25 °C* | 90 CRI Minimum 90 TLCI Minimum | 95 CRI Minimum 95 TLCI Minimum |
| E2 | 5700 K | M2 | 1380 | 1520 | XHP70D-00-B001-AD0UM20E2 | |
| | | K4 | 1290 | 1420 | | XHP70D-00-B001-AD0ZK40E2 |

Notes

- TLCI refers to the [European Broadcast Union's Television Lighting Consistency Index 2012](#), which aids broadcasters in assessing the colorimetric quality of lighting in their production environment. Cree LED maintains a tolerance of ± 2 on TLCI measurements. See the Measurements section (page 32).
- Cree LED maintains a tolerance of $\pm 7\%$ on flux and power measurements, ± 0.005 on chromaticity (CCx, CCy) measurements and a tolerance of ± 2 on CRI measurements. See the Measurements section (page 32).
- XLamp XHP70.3 LED order codes specify only a minimum flux bin and not a maximum. Cree LED may ship reels in flux bins higher than the minimum specified by the order code without advance notice. Shipments will always adhere to the chromaticity bin restrictions specified by the order code.
- Flux values @ 25 °C are calculated and for reference only.

FLUX CHARACTERISTICS, HIGH INTENSITY EASYWHITE® ORDER CODES AND BINS

The following table provides order codes for XLamp XHP70.3 High Intensity LEDs. For a complete description of how the flux and chromaticity groups are reflected in the bin code and order code nomenclature, please see the Bin and Order Code Formats section (page 30).

Binning condition: $T_j = 85\text{ }^\circ\text{C}$; 12 V, $I_f = 1050\text{ mA}$
 Reference condition: $T_j = 85\text{ }^\circ\text{C}$; 6 V, $I_f = 2100\text{ mA}$

| Nominal CCT | CRI | | Minimum Luminous Flux | | | 2-Step | | 3-Step | | 5-Step | |
|-------------|-----|-----|-----------------------|-------------------|--------------------|--------|------------|--------|--------------------------|--------|--------------------------|
| | Min | Typ | Group | Flux (lm) @ 85 °C | Flux (lm) @ 25 °C* | Group | Order Code | Group | Order Code | Group | Order Code |
| 5000 K | 70 | | P2 | 1830 | 2015 | | | | | 50E | XHP70D-H0-0000-0D0BP250E |
| | | | N4 | 1710 | 1883 | | | | XHP70D-H0-0000-0D0BN450E | | |
| | 80 | | N2 | 1590 | 1751 | | | 50G | XHP70D-H0-0000-0D0HN250G | | |
| | | | M4 | 1485 | 1635 | | | | XHP70D-H0-0000-0D0HM450G | | |
| | 90 | | M4 | 1485 | 1635 | | | 50G | XHP70D-H0-0000-0D0UM450G | | |
| | | | M2 | 1380 | 1520 | | | | XHP70D-H0-0000-0D0UM250G | | |
| 4500 K | 70 | | P2 | 1830 | 2015 | | | | | 45E | XHP70D-H0-0000-0D0BP245E |
| | | | N4 | 1710 | 1883 | | | | XHP70D-H0-0000-0D0BN445E | | |
| | 80 | | N2 | 1590 | 1751 | | | 45G | XHP70D-H0-0000-0D0HN245G | | |
| | | | M4 | 1485 | 1635 | | | | XHP70D-H0-0000-0D0HM445G | | |
| | 90 | | M2 | 1380 | 1520 | | | 45G | XHP70D-H0-0000-0D0UM245G | | |
| | | | K4 | 1290 | 1420 | | | | XHP70D-H0-0000-0D0UK445G | | |

- Notes**
- Cree LED maintains a tolerance of $\pm 7\%$ on flux and power measurements, ± 0.005 on chromaticity (CCx, CCy) measurements and a tolerance of ± 2 on CRI measurements. See the Measurements section (page 32).
 - XLamp XHP70.3 LED order codes specify only a minimum flux bin and not a maximum. Cree LED may ship reels in flux bins higher than the minimum specified by the order code without advance notice. Shipments will always adhere to the chromaticity bin restrictions specified by the order code.
 - Flux values @ 25 °C are calculated and for reference only.

FLUX CHARACTERISTICS, HIGH INTENSITY EASYWHITE® ORDER CODES AND BINS - CONTINUED

| Nominal CCT | CRI | | Minimum Luminous Flux | | | 2-Step | | 3-Step | | 5-Step | | |
|-------------|--------|-----|-----------------------|-------------------|--------------------------|--------------------------|--------------------------|--------------------------|--------------------------|--------------------------|--------------------------|--------------------------|
| | Min | Typ | Group | Flux (lm) @ 85 °C | Flux (lm) @ 25 °C* | Group | Order Code | Group | Order Code | Group | Order Code | |
| 4000 K | 70 | | P2 | 1830 | 2015 | | | | | 40E | XHP70D-H0-0000-0D0BP240E | |
| | | | N4 | 1710 | 1883 | | | | | | XHP70D-H0-0000-0D0BN440E | |
| | 80 | | N2 | 1590 | 1751 | 40H | XHP70D-H0-0000-0D0HN240H | 40G | XHP70D-H0-0000-0D0HN240G | | | |
| | | | M4 | 1485 | 1635 | | XHP70D-H0-0000-0D0HM440H | | XHP70D-H0-0000-0D0HM440G | | | |
| | 90 | | M2 | 1380 | 1520 | 40H | XHP70D-H0-0000-0D0UM240H | 40G | XHP70D-H0-0000-0D0UM240G | | | |
| | | | K4 | 1290 | 1420 | | XHP70D-H0-0000-0D0UK440H | | XHP70D-H0-0000-0D0UK440G | | | |
| | 95 | | K4 | 1290 | 1420 | 40H | XHP70D-H0-0000-0D0ZK440H | 40G | XHP70D-H0-0000-0D0ZK440G | | | |
| | | | K2 | 1200 | 1321 | | XHP70D-H0-0000-0D0ZK240H | | XHP70D-H0-0000-0D0ZK240G | | | |
| | | J4 | 1120 | 1233 | XHP70D-H0-0000-0D0ZJ440H | | XHP70D-H0-0000-0D0ZJ440G | | | | | |
| | 3500 K | 70 | | N4 | 1710 | 1883 | | | | | 35E | XHP70D-H0-0000-0D0BN435E |
| | | | | N2 | 1590 | 1751 | | | | | | XHP70D-H0-0000-0D0BN235E |
| | | 80 | | N2 | 1590 | 1751 | 35H | XHP70D-H0-0000-0D0HN235H | 35G | XHP70D-H0-0000-0D0HN235G | | |
| | | | M4 | 1485 | 1635 | XHP70D-H0-0000-0D0HM435H | | XHP70D-H0-0000-0D0HM435G | | | | |
| 90 | | | K4 | 1290 | 1420 | 35H | XHP70D-H0-0000-0D0UK435H | 35G | XHP70D-H0-0000-0D0UK435G | | | |
| | | | K2 | 1200 | 1321 | | XHP70D-H0-0000-0D0UK235H | | XHP70D-H0-0000-0D0UK235G | | | |
| 95 | | | K2 | 1200 | 1321 | 35H | XHP70D-H0-0000-0D0ZK235H | 35G | XHP70D-H0-0000-0D0ZK235G | | | |
| | | | J4 | 1120 | 1233 | | XHP70D-H0-0000-0D0ZJ435H | | XHP70D-H0-0000-0D0ZJ435G | | | |
| | | J2 | 1040 | 1145 | XHP70D-H0-0000-0D0ZJ235H | | XHP70D-H0-0000-0D0ZJ235G | | | | | |
| | | H4 | 970 | 1068 | XHP70D-H0-0000-0D0ZH435H | | XHP70D-H0-0000-0D0ZH435G | | | | | |

- Notes**
- Cree LED maintains a tolerance of ±7% on flux and power measurements, ±0.005 on chromaticity (CCx, CCy) measurements and a tolerance of ±2 on CRI measurements. See the Measurements section (page 32).
 - XLamp XHP70.3 LED order codes specify only a minimum flux bin and not a maximum. Cree LED may ship reels in flux bins higher than the minimum specified by the order code without advance notice. Shipments will always adhere to the chromaticity bin restrictions specified by the order code.
 - Flux values @ 25 °C are calculated and for reference only.

FLUX CHARACTERISTICS, HIGH INTENSITY EASYWHITE® ORDER CODES AND BINS - CONTINUED

| Nominal CCT | CRI | | Minimum Luminous Flux | | | 2-Step | | 3-Step | | 5-Step | | |
|-------------|--------|-----|-----------------------|-------------------|--------------------|--------|--------------------------|--------------------------|--------------------------|--------------------------|--------------------------|--|
| | Min | Typ | Group | Flux (lm) @ 85 °C | Flux (lm) @ 25 °C* | Group | Order Code | Group | Order Code | Group | Order Code | |
| 3000 K | 70 | | N4 | 1710 | 1883 | | | | | 30E | XHP70D-H0-0000-0D0BN430E | |
| | | | N2 | 1590 | 1751 | | XHP70D-H0-0000-0D0BN230E | | | | | |
| | 80 | | N2 | 1590 | 1751 | 30H | XHP70D-H0-0000-0D0HN230H | 30G | XHP70D-H0-0000-0D0HN230G | | | |
| | | | M4 | 1485 | 1635 | | XHP70D-H0-0000-0D0HM430H | | XHP70D-H0-0000-0D0HM430G | | | |
| | 90 | | K4 | 1290 | 1420 | 30H | XHP70D-H0-0000-0D0UK430H | 30G | XHP70D-H0-0000-0D0UK430G | | | |
| | | | K2 | 1200 | 1321 | | XHP70D-H0-0000-0D0UK230H | | XHP70D-H0-0000-0D0UK230G | | | |
| | 95 | | K2 | 1200 | 1321 | 30H | XHP70D-H0-0000-0D0ZK230H | 30G | XHP70D-H0-0000-0D0ZK230G | | | |
| | | | J4 | 1120 | 1233 | | XHP70D-H0-0000-0D0ZJ430H | | XHP70D-H0-0000-0D0ZJ430G | | | |
| | | | J2 | 1040 | 1145 | | XHP70D-H0-0000-0D0ZJ230H | | XHP70D-H0-0000-0D0ZJ230G | | | |
| | | | H4 | 970 | 1068 | | XHP70D-H0-0000-0D0ZH430H | | XHP70D-H0-0000-0D0ZH430G | | | |
| | 2700 K | 80 | | M4 | 1485 | 1635 | 27H | XHP70D-H0-0000-0D0HM427H | 27G | XHP70D-H0-0000-0D0HM427G | | |
| | | | | M2 | 1380 | 1520 | | XHP70D-H0-0000-0D0HM227H | | XHP70D-H0-0000-0D0HM227G | | |
| 90 | | | K2 | 1200 | 1321 | 27H | XHP70D-H0-0000-0D0UK227H | 27G | XHP70D-H0-0000-0D0UK227G | | | |
| | | | J4 | 1120 | 1233 | | XHP70D-H0-0000-0D0UJ427H | | XHP70D-H0-0000-0D0UJ427G | | | |
| 95 | | | J4 | 1120 | 1233 | 27H | XHP70D-H0-0000-0D0ZJ427H | 27G | XHP70D-H0-0000-0D0ZJ427G | | | |
| | | | J2 | 1040 | 1145 | | XHP70D-H0-0000-0D0ZJ227H | | XHP70D-H0-0000-0D0ZJ227G | | | |
| | | | H4 | 970 | 1068 | | XHP70D-H0-0000-0D0ZH427H | | XHP70D-H0-0000-0D0ZH427G | | | |
| | | | H2 | 900 | 991 | | XHP70D-H0-0000-0D0ZH227H | | XHP70D-H0-0000-0D0ZH227G | | | |

- Notes**
- Cree LED maintains a tolerance of ±7% on flux and power measurements, ±0.005 on chromaticity (CCx, CCy) measurements and a tolerance of ±2 on CRI measurements. See the Measurements section (page 32).
 - XLamp XHP70.3 LED order codes specify only a minimum flux bin and not a maximum. Cree LED may ship reels in flux bins higher than the minimum specified by the order code without advance notice. Shipments will always adhere to the chromaticity bin restrictions specified by the order code.
 - Flux values @ 25 °C are calculated and for reference only.

FLUX CHARACTERISTICS, HIGH INTENSITY ANSI WHITE ORDER CODES AND BINS

The following table provides order codes for XLamp XHP70.3 High Intensity LEDs. For a complete description of how the flux and chromaticity groups are reflected in the bin code and order code nomenclature, please see the Bin and Order Code Formats section (page 30).

Binning condition: $T_j = 85\text{ °C}$; 12 V, $I_f = 1050\text{ mA}$

Reference condition: $T_j = 85\text{ °C}$; 6 V, $I_f = 2100\text{ mA}$

| Nominal CCT | Chromaticity Regions | CRI | | Minimum Luminous Flux | | | Order Code | | |
|-------------|---|--------|----------------|-----------------------|-------------------|--------------------|--------------------------|------|--------------------------|
| | | Min | Typ | Group | Flux (lm) @ 85 °C | Flux (lm) @ 25 °C* | | | |
| 7000 K | 0A, 0B, 0C, 0D, 0R, 0S, 0T, 0U, 1A, 1B, 1C, 1D, 1R, 1S, 1T, 1U | 0 | 68 | P2 | 1830 | 2015 | XHP70D-H0-0000-0D00P20DT | | |
| | | | | N4 | 1710 | 1883 | XHP70D-H0-0000-0D00N40DT | | |
| | | | | N2 | 1590 | 1751 | XHP70D-H0-0000-0D00N20DT | | |
| | | 70 | | P2 | 1830 | 2015 | XHP70D-H0-0000-0D0BP20DT | | |
| | | | | N4 | 1710 | 1883 | XHP70D-H0-0000-0D0BN40DT | | |
| | | | | N2 | 1590 | 1751 | XHP70D-H0-0000-0D0BN20DT | | |
| | | 80 | | N2 | 1590 | 1751 | XHP70D-H0-0000-0D0HN20DT | | |
| | | | | M4 | 1485 | 1635 | XHP70D-H0-0000-0D0HM40DT | | |
| | | 6500 K | 1A, 1B, 1C, 1D | 0 | 68 | P2 | 1830 | 2015 | XHP70D-H0-0000-0D00P20E1 |
| N4 | 1710 | | | | | 1883 | XHP70D-H0-0000-0D00N40E1 | | |
| N2 | 1590 | | | | | 1751 | XHP70D-H0-0000-0D00N20E1 | | |
| 70 | | | | N4 | 1710 | 1883 | XHP70D-H0-0000-0D0BN40E1 | | |
| | | | | N2 | 1590 | 1751 | XHP70D-H0-0000-0D0BN20E1 | | |
| 80 | | | | N2 | 1590 | 1751 | XHP70D-H0-0000-0D0HN20E1 | | |
| | | | | M4 | 1485 | 1635 | XHP70D-H0-0000-0D0HM40E1 | | |
| 6000 K | 1A, 1B, 1C, 1D, 1R, 1S, 1T, 1U, 2A, 2B, 2C, 2D, 2R, 2S, 2T, 2U | | | 0 | 68 | P2 | 1830 | 2015 | XHP70D-H0-0000-0D00P20DV |
| | | | | | | N4 | 1710 | 1883 | XHP70D-H0-0000-0D00N40DV |
| | | 70 | | P2 | 1830 | 2015 | XHP70D-H0-0000-0D0BP20DV | | |
| | | | | N4 | 1710 | 1883 | XHP70D-H0-0000-0D0BN40DV | | |
| | | 80 | | N2 | 1590 | 1751 | XHP70D-H0-0000-0D0HN20DV | | |
| | | | | M4 | 1485 | 1635 | XHP70D-H0-0000-0D0HM40DV | | |
| | | 90 | | M4 | 1485 | 1635 | XHP70D-H0-0000-0D0UM40DV | | |
| | | | | M2 | 1380 | 1520 | XHP70D-H0-0000-0D0UM20DV | | |

Notes

- Cree LED maintains a tolerance of $\pm 7\%$ on flux and power measurements, ± 0.005 on chromaticity (CCx, CCy) measurements and a tolerance of ± 2 on CRI measurements. See the Measurements section (page 32).
- XLamp XHP70.3 LED order codes specify only a minimum flux bin and not a maximum. Cree LED may ship reels in flux bins higher than the minimum specified by the order code without advance notice. Shipments will always adhere to the chromaticity bin restrictions specified by the order code.
- Flux values @ 25 °C are calculated and for reference only.

FLUX CHARACTERISTICS, HIGH INTENSITY ANSI WHITE ORDER CODES AND BINS - CONTINUED

| Nominal CCT | Chromaticity Regions | CRI | | Minimum Luminous Flux | | | Order Code |
|-------------|----------------------|-----|-----|-----------------------|-------------------|--------------------|--------------------------|
| | | Min | Typ | Group | Flux (lm) @ 85 °C | Flux (lm) @ 25 °C* | |
| 5700 K | 2A, 2B, 2C, 2D | 0 | 68 | P2 | 1830 | 2015 | XHP70D-H0-0000-0D00P20E2 |
| | | | | N4 | 1710 | 1883 | XHP70D-H0-0000-0D00N40E2 |
| | | 70 | | P2 | 1830 | 2015 | XHP70D-H0-0000-0D0BP20E2 |
| | | | | N4 | 1710 | 1883 | XHP70D-H0-0000-0D0BN40E2 |
| | | 80 | | N2 | 1590 | 1751 | XHP70D-H0-0000-0D0HN20E2 |
| | | | | M4 | 1485 | 1635 | XHP70D-H0-0000-0D0HM40E2 |
| | | 90 | | M4 | 1485 | 1635 | XHP70D-H0-0000-0D0UM40E2 |
| | | | | M2 | 1380 | 1520 | XHP70D-H0-0000-0D0UM20E2 |
| 5000 K | 3A, 3B, 3C, 3D | 0 | 68 | P2 | 1830 | 2015 | XHP70D-H0-0000-0D00P20E3 |
| | | | | N4 | 1710 | 1883 | XHP70D-H0-0000-0D00N40E3 |
| | | 70 | | P2 | 1830 | 2015 | XHP70D-H0-0000-0D0BP20E3 |
| | | | | N4 | 1710 | 1883 | XHP70D-H0-0000-0D0BN40E3 |
| | | 80 | | N2 | 1590 | 1751 | XHP70D-H0-0000-0D0HN20E3 |
| | | | | M4 | 1485 | 1635 | XHP70D-H0-0000-0D0HM40E3 |
| | | 90 | | M4 | 1485 | 1635 | XHP70D-H0-0000-0D0UM40E3 |
| | | | | M2 | 1380 | 1520 | XHP70D-H0-0000-0D0UM20E3 |
| 4500 K | 4A, 4B, 4C, 4D | 0 | 68 | P2 | 1830 | 2015 | XHP70D-H0-0000-0D00P20E4 |
| | | | | N4 | 1710 | 1883 | XHP70D-H0-0000-0D00N40E4 |
| | | 70 | | P2 | 1830 | 2015 | XHP70D-H0-0000-0D0BP20E4 |
| | | | | N4 | 1710 | 1883 | XHP70D-H0-0000-0D0BN40E4 |
| | | 80 | | N2 | 1590 | 1751 | XHP70D-H0-0000-0D0HN20E4 |
| | | | | M4 | 1485 | 1635 | XHP70D-H0-0000-0D0HM40E4 |
| | | 90 | | M2 | 1380 | 1520 | XHP70D-H0-0000-0D0UM20E4 |
| | | | | K4 | 1290 | 1420 | XHP70D-H0-0000-0D0UK40E4 |
| 4000 K | 5A, 5B, 5C, 5D | 0 | 68 | P2 | 1830 | 2015 | XHP70D-H0-0000-0D00N20E5 |
| | | | | N4 | 1710 | 1883 | XHP70D-H0-0000-0D00N40E5 |
| | | 70 | | P2 | 1830 | 2015 | XHP70D-H0-0000-0D0BP20E5 |
| | | | | N4 | 1710 | 1883 | XHP70D-H0-0000-0D0BN40E5 |
| | | 80 | | N2 | 1590 | 1751 | XHP70D-H0-0000-0D0HN20E5 |
| | | | | M4 | 1485 | 1635 | XHP70D-H0-0000-0D0HM40E5 |
| | | 90 | | M2 | 1380 | 1520 | XHP70D-H0-0000-0D0UM20E5 |
| | | | | K4 | 1290 | 1420 | XHP70D-H0-0000-0D0UK40E5 |
| 3500 K | 6A, 6B, 6C, 6D | 70 | | N4 | 1710 | 1883 | XHP70D-H0-0000-0D0BN40E6 |
| | | | | N2 | 1590 | 1751 | XHP70D-H0-0000-0D0BN20E6 |
| 3000 K | 7A, 7B, 7C, 7D | 70 | | N4 | 1710 | 1883 | XHP70D-H0-0000-0D0BN40E7 |
| | | | | N2 | 1590 | 1751 | XHP70D-H0-0000-0D0BN20E7 |

- Notes**
- Cree LED maintains a tolerance of ±7% on flux and power measurements, ±0.005 on chromaticity (CCx, CCy) measurements and a tolerance of ±2 on CRI measurements. See the Measurements section (page 32).
 - XLamp XHP70.3 LED order codes specify only a minimum flux bin and not a maximum. Cree LED may ship reels in flux bins higher than the minimum specified by the order code without advance notice. Shipments will always adhere to the chromaticity bin restrictions specified by the order code.
 - Flux values @ 25 °C are calculated and for reference only.

FLUX CHARACTERISTICS, HIGH INTENSITY BROADCAST ORDER CODES AND BINS

The following table provides order codes for XLamp XHP70.3 High Intensity Broadcast LEDs. For a complete description of how the flux and chromaticity groups are reflected in the bin code and order code nomenclature, please see the Bin and Order Code Formats section (page 30).

Binning condition: $T_j = 85\text{ °C}$; 12 V, $I_f = 1050\text{ mA}$

Reference condition: $T_j = 85\text{ °C}$; 6 V, $I_f = 2100\text{ mA}$

| Chromaticity | | Minimum Luminous Flux (lm) @ 1050 mA | | | Order Codes | |
|--------------|--------|---|----------------------|-----------------------|-----------------------------------|-----------------------------------|
| Kit | CCT | Flux Bin | Flux (lm) @ 85 °C | Flux (lm) @ 25 °C* | 90 CRI Minimum 90 TLCI Minimum | 95 CRI Minimum 95 TLCI Minimum |
| E2 | 5700 K | K4 | 1290 | 1420 | XHP70D-H0-B001-AD0UK40E2 | |
| | | K2 | 1200 | 1321 | | XHP70D-H0-B001-AD0ZK20E2 |

Notes

- TLCI refers to the [European Broadcast Union's Television Lighting Consistency Index 2012](#), which aids broadcasters in assessing the colorimetric quality of lighting in their production environment. Cree LED maintains a tolerance of ± 2 on TLCI measurements. See the Measurements section (page 32).
- Cree LED maintains a tolerance of $\pm 7\%$ on flux and power measurements, ± 0.005 on chromaticity (CCx, CCy) measurements and a tolerance of ± 2 on CRI measurements. See the Measurements section (page 32).
- XLamp XHP70.3 LED order codes specify only a minimum flux bin and not a maximum. Cree LED may ship reels in flux bins higher than the minimum specified by the order code without advance notice. Shipments will always adhere to the chromaticity bin restrictions specified by the order code.
- Flux values @ 25 °C are calculated and for reference only.

RELATIVE SPECTRAL POWER DISTRIBUTION

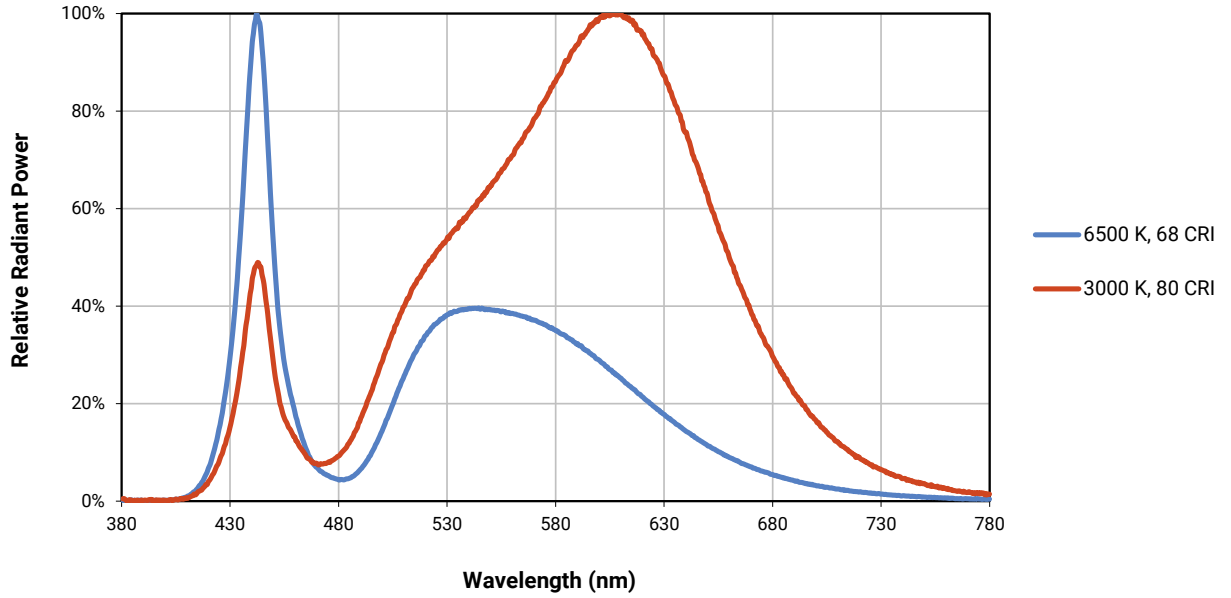

RELATIVE FLUX VS. JUNCTION TEMPERATURE

Reference condition: 6 V, $I_f = 2100$ mA; 12 V, $I_f = 1050$ mA

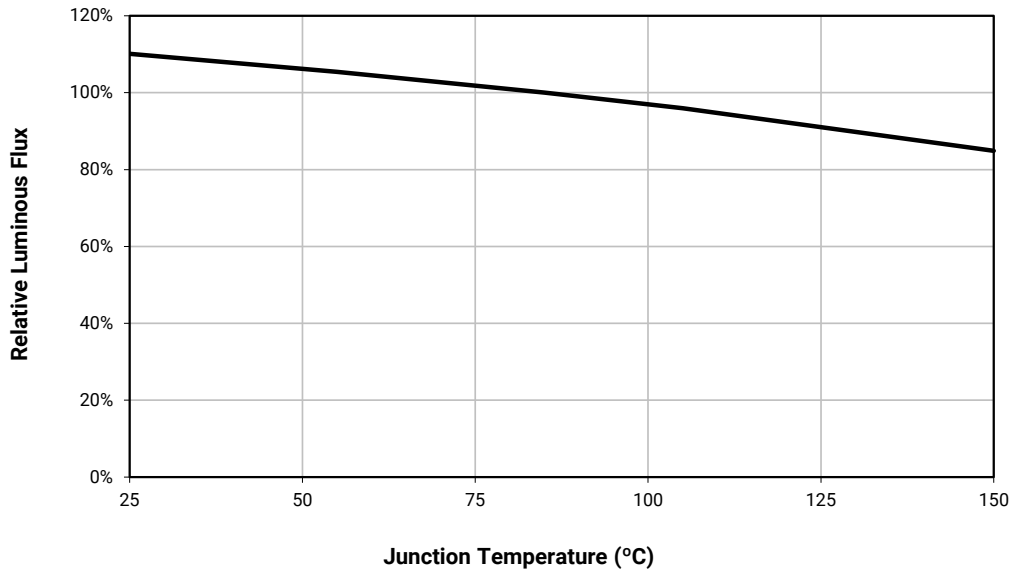

ELECTRICAL CHARACTERISTICS ($T_j = 85\text{ }^\circ\text{C}$)

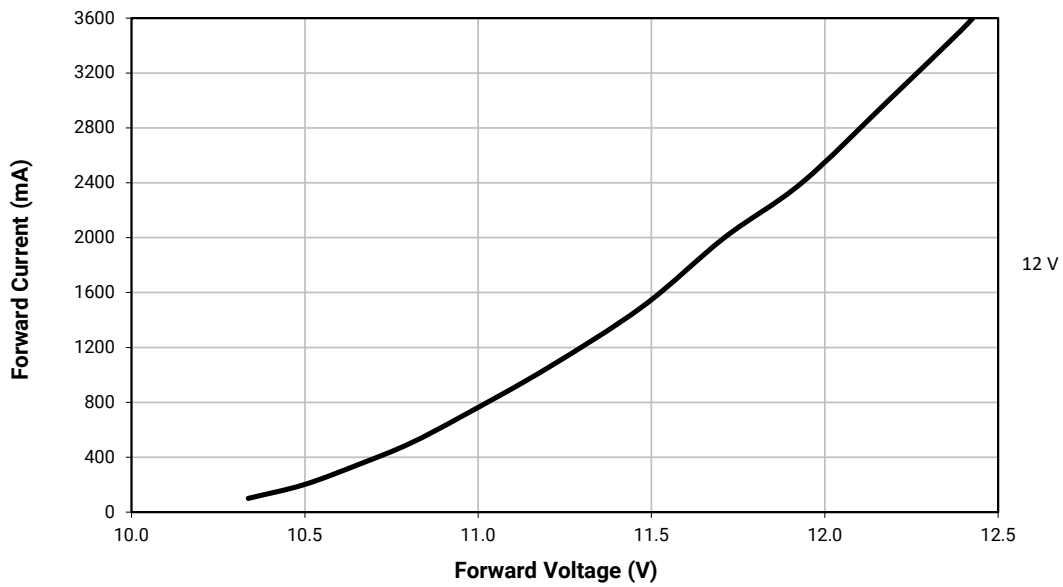
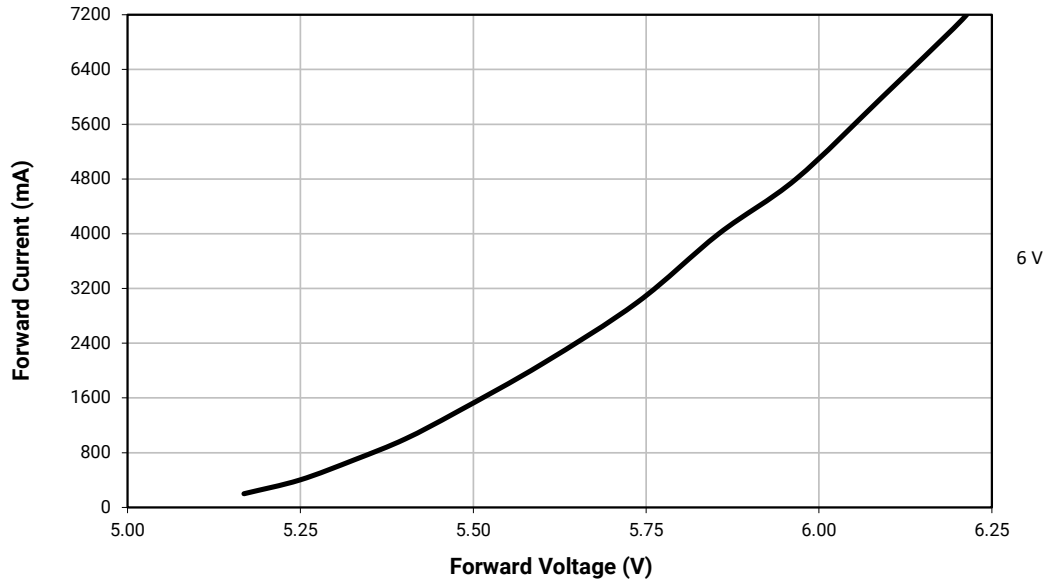

RELATIVE FLUX VS. CURRENT ($T_j = 85\text{ }^\circ\text{C}$)

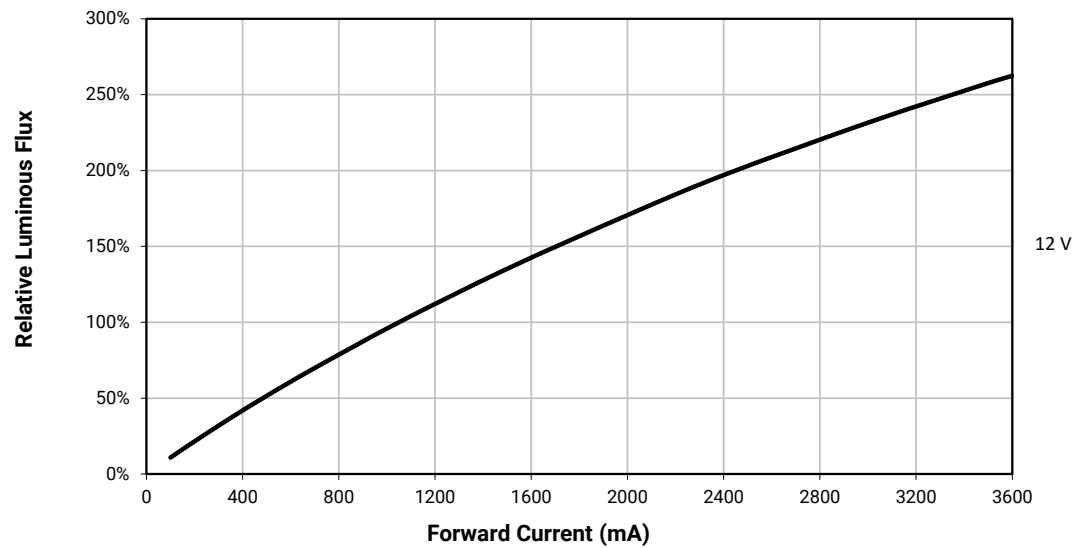
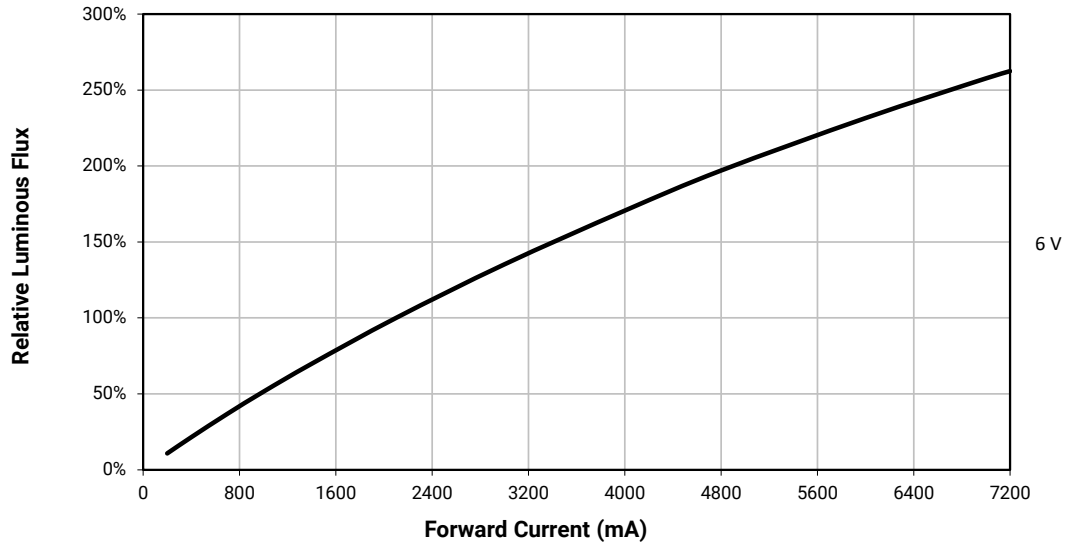

RELATIVE CHROMATICITY VS CURRENT (WARM WHITE)

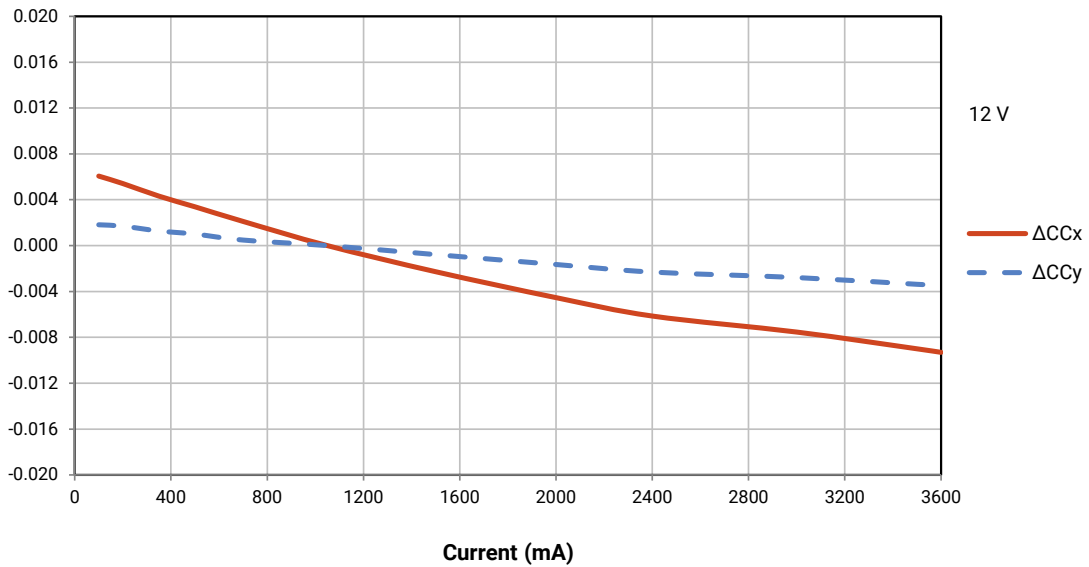
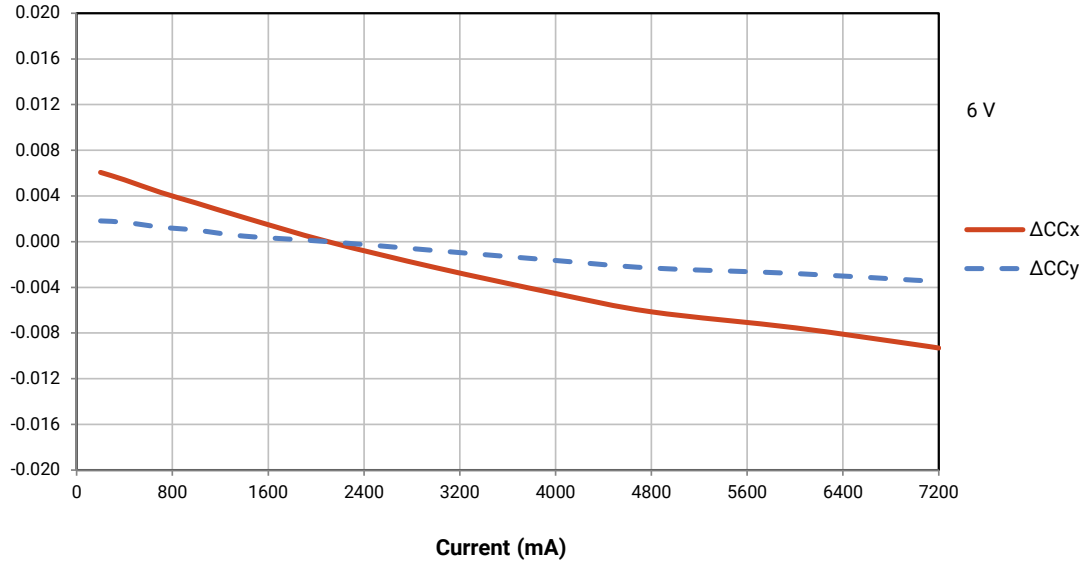

RELATIVE CHROMATICITY VS TEMPERATURE (WARM WHITE)

Reference condition: 6 V, $I_F = 2100$ mA; 12 V, $I_F = 1050$ mA

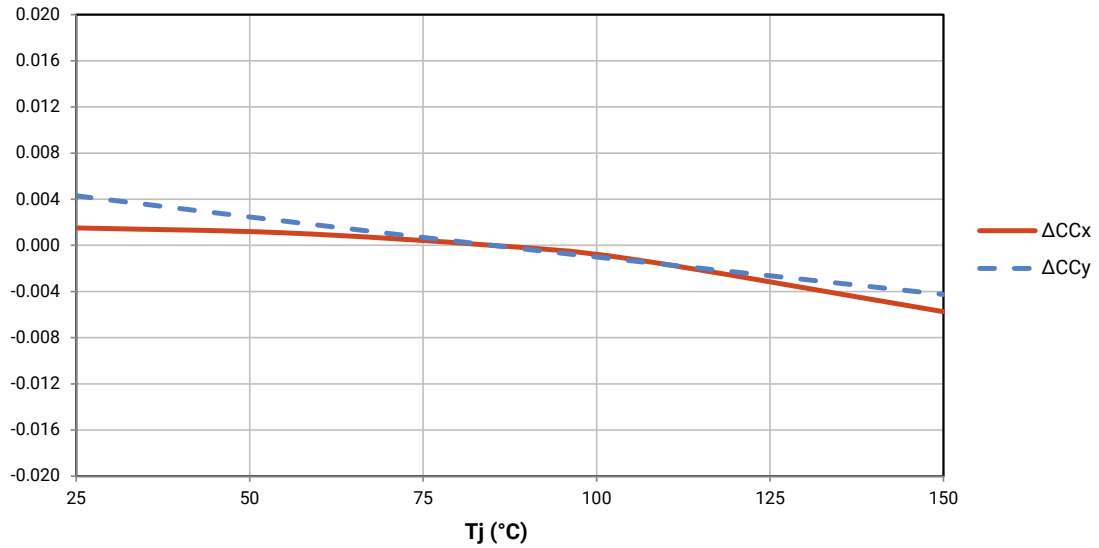

TYPICAL SPATIAL DISTRIBUTION

Reference condition: $T_j = 85$ °C; 6 V, $I_F = 2100$ mA; 12 V, $I_F = 1050$ mA

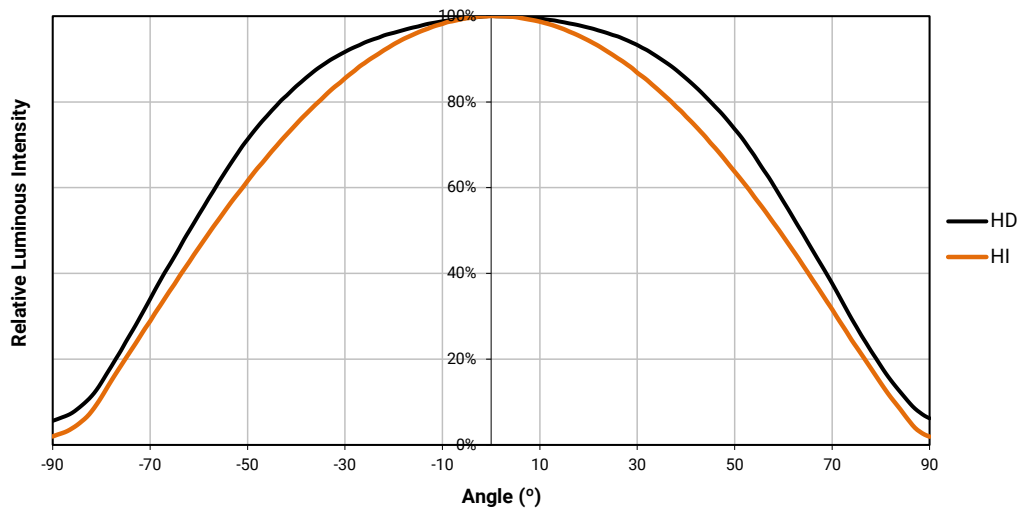

THERMAL DESIGN

The maximum forward current is determined by the thermal resistance between the LED junction and ambient. It is crucial for the end product to be designed in a manner that minimizes the thermal resistance from the solder point to ambient in order to optimize lamp life and optical characteristics.

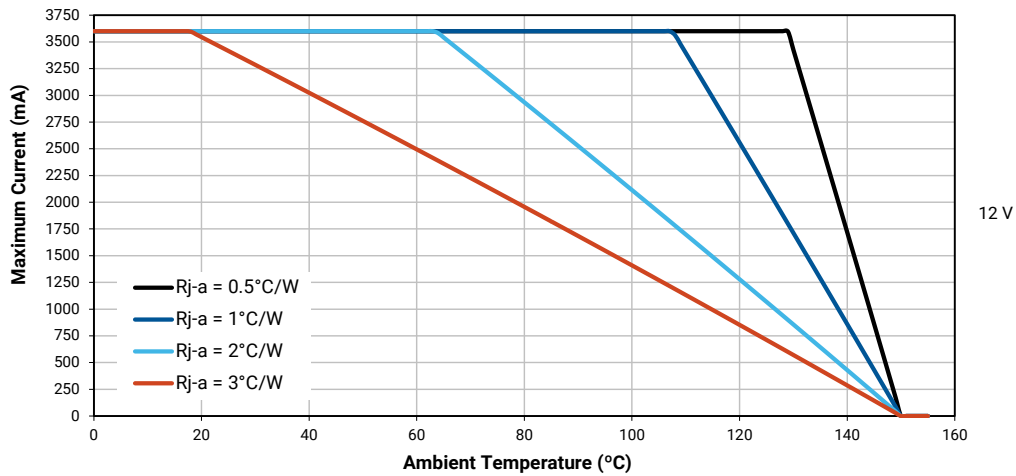
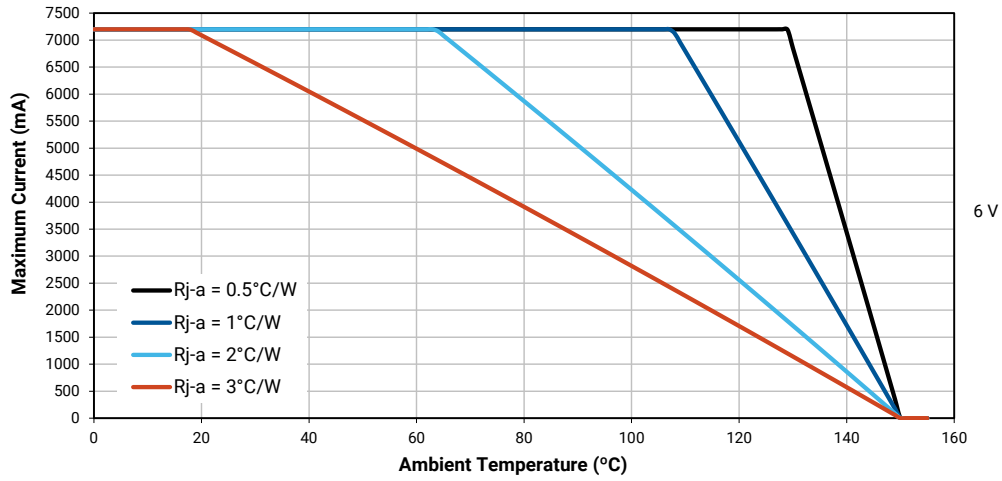

PERFORMANCE GROUPS - LUMINOUS FLUX ($T_j = 85\text{ }^\circ\text{C}$)

XLamp XHP70.3 LEDs are tested for luminous flux and placed into one of the following luminous-flux groups.

| Group Code | Minimum Luminous Flux | Maximum Luminous Flux |
|------------|-----------------------|-----------------------|
| H2 | 900 | 970 |
| H4 | 970 | 1040 |
| J2 | 1040 | 1120 |
| J4 | 1120 | 1200 |
| K2 | 1200 | 1290 |
| K4 | 1290 | 1380 |
| M2 | 1380 | 1485 |
| M4 | 1485 | 1590 |
| N2 | 1590 | 1710 |
| N4 | 1710 | 1830 |
| P2 | 1830 | 1965 |
| P4 | 1965 | 2100 |
| Q2 | 2100 | 2260 |

PERFORMANCE GROUPS - CHROMATICITY

XLamp XHP70.3 LEDs are tested for chromaticity and placed into one of the regions defined by the following bounding coordinates.

| EasyWhite Color Temperatures – 2-Step | | | |
|---------------------------------------|--------|--------|--------|
| Code | CCT | x | y |
| 40H | 4000 K | 0.3777 | 0.3739 |
| | | 0.3797 | 0.3816 |
| | | 0.3861 | 0.3855 |
| | | 0.3838 | 0.3777 |
| 35H | 3500 K | 0.4022 | 0.3858 |
| | | 0.4053 | 0.3942 |
| | | 0.4125 | 0.3977 |
| | | 0.4091 | 0.3891 |
| 30H | 3000 K | 0.4287 | 0.3975 |
| | | 0.4328 | 0.4064 |
| | | 0.4390 | 0.4086 |
| | | 0.4347 | 0.3996 |
| 27H | 2700 K | 0.4524 | 0.4048 |
| | | 0.4574 | 0.4140 |
| | | 0.4633 | 0.4154 |
| | | 0.4581 | 0.4062 |

PERFORMANCE GROUPS - CHROMATICITY (CONTINUED)

| EasyWhite Color Temperatures – 3-Step Ellipse | | | | | | |
|---|--------|--------------|--------|------------|------------|--------------------|
| Bin Code | CCT | Center Point | | Major Axis | Minor Axis | Rotation Angle (°) |
| | | x | y | a | b | |
| 50G | 5000 K | 0.3447 | 0.3553 | 0.00840 | 0.00312 | 65.0 |
| 45G | 4500 K | 0.3611 | 0.3658 | 0.00852 | 0.00330 | 61.5 |
| 40G | 4000 K | 0.3818 | 0.3797 | 0.00939 | 0.00402 | 53.7 |
| 35G | 3500 K | 0.4073 | 0.3917 | 0.00927 | 0.00414 | 54.0 |
| 30G | 3000 K | 0.4338 | 0.4030 | 0.00834 | 0.00408 | 53.2 |
| 27G | 2700 K | 0.4577 | 0.4099 | 0.00834 | 0.00420 | 48.5 |

| EasyWhite Color Temperatures – 5-Step Ellipse | | | | | | |
|---|--------|--------------|--------|------------|------------|--------------------|
| Bin Code | CCT | Center Point | | Major Axis | Minor Axis | Rotation Angle (°) |
| | | x | y | a | b | |
| 50E | 5000 K | 0.3447 | 0.3553 | 0.01400 | 0.00520 | 65.0 |
| 45E | 4500 K | 0.3611 | 0.3658 | 0.01420 | 0.00550 | 61.5 |
| 40E | 4000 K | 0.3818 | 0.3797 | 0.01565 | 0.00670 | 53.7 |
| 35E | 3500 K | 0.4073 | 0.3917 | 0.01545 | 0.00690 | 54.0 |
| 30E | 3000 K | 0.4338 | 0.4030 | 0.01390 | 0.00680 | 53.2 |

| ANSI White Bins | | | |
|-----------------|----------|--------|--------|
| CCT | Bin Code | x | y |
| 7000 K | 0A0 | 0.2950 | 0.2970 |
| | | 0.2920 | 0.3060 |
| | | 0.2984 | 0.3133 |
| | | 0.3009 | 0.3042 |
| | 0B0 | 0.2920 | 0.3060 |
| | | 0.2895 | 0.3135 |
| | | 0.2962 | 0.3220 |
| | | 0.2984 | 0.3133 |
| | 0C0 | 0.2984 | 0.3133 |
| | | 0.2962 | 0.3220 |
| | | 0.3028 | 0.3304 |
| | | 0.3048 | 0.3207 |
| | 0D0 | 0.2984 | 0.3133 |
| | | 0.3048 | 0.3207 |
| | | 0.3068 | 0.3113 |
| | | 0.3009 | 0.3042 |

| ANSI White Bins | | | |
|-----------------|----------|--------|--------|
| CCT | Bin Code | x | y |
| 7000 K | 0R0 | 0.2980 | 0.2880 |
| | | 0.2950 | 0.2970 |
| | | 0.3009 | 0.3042 |
| | | 0.3037 | 0.2937 |
| | 0S0 | 0.2895 | 0.3135 |
| | | 0.2870 | 0.3210 |
| | | 0.2937 | 0.3312 |
| | | 0.2962 | 0.3220 |
| | 0T0 | 0.2962 | 0.3220 |
| | | 0.2937 | 0.3312 |
| | | 0.3005 | 0.3415 |
| | | 0.3028 | 0.3304 |
| | 0U0 | 0.3037 | 0.2937 |
| | | 0.3009 | 0.3042 |
| | | 0.3068 | 0.3113 |
| | | 0.3093 | 0.2993 |

| ANSI White Bins | | | |
|-----------------|----------|--------|--------|
| CCT | Bin Code | x | y |
| 7000 K | 1A0 | 0.3048 | 0.3207 |
| | | 0.3130 | 0.3290 |
| | | 0.3144 | 0.3186 |
| | | 0.3068 | 0.3113 |
| | 1B0 | 0.3028 | 0.3304 |
| | | 0.3115 | 0.3391 |
| | | 0.3130 | 0.3290 |
| | | 0.3048 | 0.3207 |
| | 1C0 | 0.3115 | 0.3391 |
| | | 0.3205 | 0.3481 |
| | | 0.3213 | 0.3373 |
| | | 0.3130 | 0.3290 |
| | 1D0 | 0.3130 | 0.3290 |
| | | 0.3213 | 0.3373 |
| | | 0.3221 | 0.3261 |
| | | 0.3144 | 0.3186 |

PERFORMANCE GROUPS - CHROMATICITY (CONTINUED)

| ANSI White Bins | | | |
|-----------------|----------|--------|--------|
| CCT | Bin Code | x | y |
| 7000 K | 1R0 | 0.3068 | 0.3113 |
| | | 0.3144 | 0.3186 |
| | | 0.3161 | 0.3059 |
| | | 0.3093 | 0.2993 |
| | 1S0 | 0.3005 | 0.3415 |
| | | 0.3099 | 0.3509 |
| | | 0.3115 | 0.3391 |
| | | 0.3028 | 0.3304 |
| | 1T0 | 0.3099 | 0.3509 |
| | | 0.3196 | 0.3602 |
| | | 0.3205 | 0.3481 |
| | | 0.3115 | 0.3391 |
| | 1U0 | 0.3144 | 0.3186 |
| | | 0.3221 | 0.3261 |
| | | 0.3231 | 0.3120 |
| | | 0.3161 | 0.3059 |

| ANSI White Bins | | | |
|-----------------|----------|--------|--------|
| CCT | Bin Code | x | y |
| 6000 K | 2A0 | 0.3215 | 0.3350 |
| | | 0.3290 | 0.3417 |
| | | 0.3290 | 0.3300 |
| | | 0.3222 | 0.3243 |
| | 2B0 | 0.3207 | 0.3462 |
| | | 0.3290 | 0.3538 |
| | | 0.3290 | 0.3417 |
| | | 0.3215 | 0.3350 |
| | 2C0 | 0.3290 | 0.3538 |
| | | 0.3376 | 0.3616 |
| | | 0.3371 | 0.3490 |
| | | 0.3290 | 0.3417 |
| | 2D0 | 0.3290 | 0.3417 |
| | | 0.3371 | 0.3490 |
| | | 0.3366 | 0.3369 |
| | | 0.3290 | 0.3300 |

| ANSI White Bins | | | |
|-----------------|----------|--------|--------|
| CCT | Bin Code | x | y |
| 6000 K | 2R0 | 0.3222 | 0.3243 |
| | | 0.3290 | 0.3300 |
| | | 0.3290 | 0.3180 |
| | | 0.3231 | 0.3120 |
| | 2S0 | 0.3196 | 0.3602 |
| | | 0.3290 | 0.3690 |
| | | 0.3290 | 0.3538 |
| | | 0.3207 | 0.3462 |
| | 2T0 | 0.3290 | 0.3690 |
| | | 0.3381 | 0.3762 |
| | | 0.3376 | 0.3616 |
| | | 0.3290 | 0.3538 |
| | 2U0 | 0.3290 | 0.3300 |
| | | 0.3366 | 0.3369 |
| | | 0.3361 | 0.3245 |
| | | 0.3290 | 0.3180 |

| ANSI White Bins | | | |
|-----------------|----------|--------|--------|
| CCT | Bin Code | x | y |
| 5000 K | 3A0 | 0.3371 | 0.3490 |
| | | 0.3451 | 0.3554 |
| | | 0.3440 | 0.3427 |
| | | 0.3366 | 0.3369 |
| | 3B0 | 0.3376 | 0.3616 |
| | | 0.3463 | 0.3687 |
| | | 0.3451 | 0.3554 |
| | | 0.3371 | 0.3490 |
| | 3C0 | 0.3463 | 0.3687 |
| | | 0.3551 | 0.3760 |
| | | 0.3533 | 0.3620 |
| | | 0.3451 | 0.3554 |
| | 3D0 | 0.3451 | 0.3554 |
| | | 0.3533 | 0.3620 |
| | | 0.3515 | 0.3487 |
| | | 0.3440 | 0.3427 |

| ANSI White Bins | | | |
|-----------------|----------|--------|--------|
| CCT | Bin Code | x | y |
| 4500 K | 4A0 | 0.3530 | 0.3597 |
| | | 0.3615 | 0.3659 |
| | | 0.3512 | 0.3465 |
| | | 0.3515 | 0.3487 |
| | 4B0 | 0.3548 | 0.3736 |
| | | 0.3641 | 0.3804 |
| | | 0.3530 | 0.3597 |
| | | 0.3533 | 0.362 |
| | 4C0 | 0.3641 | 0.3804 |
| | | 0.3736 | 0.3874 |
| | | 0.3702 | 0.3722 |
| | | 0.3615 | 0.3659 |
| | 4D0 | 0.3615 | 0.3659 |
| | | 0.3702 | 0.3722 |
| | | 0.3670 | 0.3578 |
| | | 0.3590 | 0.3521 |

PERFORMANCE GROUPS - CHROMATICITY (CONTINUED)

| ANSI White Bins | | | |
|-----------------|----------|--------|--------|
| CCT | Bin Code | x | y |
| 4000 K | 5A0 | 0.3670 | 0.3578 |
| | | 0.3702 | 0.3722 |
| | | 0.3825 | 0.3798 |
| | | 0.3783 | 0.3646 |
| | 5B0 | 0.3702 | 0.3722 |
| | | 0.3736 | 0.3874 |
| | | 0.3869 | 0.3958 |
| | | 0.3825 | 0.3798 |
| | 5C0 | 0.3825 | 0.3798 |
| | | 0.3869 | 0.3958 |
| | | 0.4006 | 0.4044 |
| | | 0.3950 | 0.3875 |
| | 5D0 | 0.3783 | 0.3646 |
| | | 0.3825 | 0.3798 |
| | | 0.3950 | 0.3875 |
| | | 0.3898 | 0.3716 |

| ANSI White Bins | | | |
|-----------------|----------|--------|--------|
| CCT | Bin Code | x | y |
| 3500 K | 6A0 | 0.3889 | 0.3690 |
| | | 0.3941 | 0.3848 |
| | | 0.4080 | 0.3916 |
| | | 0.4017 | 0.3751 |
| | 6B0 | 0.3941 | 0.3848 |
| | | 0.3996 | 0.4015 |
| | | 0.4146 | 0.4089 |
| | | 0.4080 | 0.3916 |
| | 6C0 | 0.4080 | 0.3916 |
| | | 0.4146 | 0.4089 |
| | | 0.4299 | 0.4165 |
| | | 0.4221 | 0.3984 |
| | 6D0 | 0.4017 | 0.3751 |
| | | 0.4080 | 0.3916 |
| | | 0.4221 | 0.3984 |
| | | 0.4147 | 0.3814 |

| ANSI White Bins | | | |
|-----------------|----------|--------|--------|
| CCT | Bin Code | x | y |
| 3000 K | 7A0 | 0.4147 | 0.3814 |
| | | 0.4221 | 0.3984 |
| | | 0.4342 | 0.4028 |
| | | 0.4259 | 0.3853 |
| | 7B0 | 0.4221 | 0.3984 |
| | | 0.4299 | 0.4165 |
| | | 0.4430 | 0.4212 |
| | | 0.4342 | 0.4028 |
| | 7C0 | 0.4342 | 0.4028 |
| | | 0.4430 | 0.4212 |
| | | 0.4562 | 0.4260 |
| | | 0.4465 | 0.4071 |
| | 7D0 | 0.4259 | 0.3853 |
| | | 0.4342 | 0.4028 |
| | | 0.4465 | 0.4071 |
| | | 0.4373 | 0.3893 |

EASYWHITE® CHROMATICITY REGIONS PLOTTED ON THE 1931 CIE CURVE

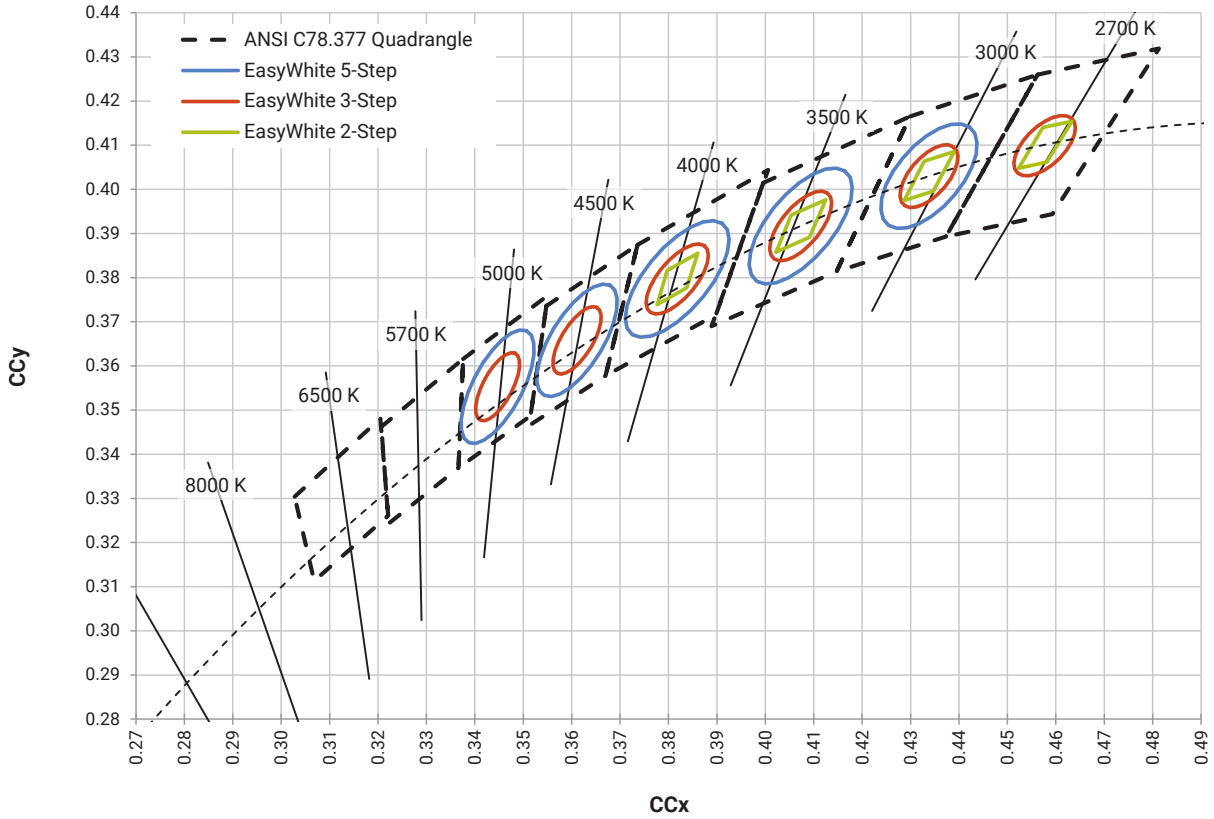

ANSI STANDARD COOL WHITE KITS PLOTTED ON ANSI STANDARD CHROMATICITY REGIONS

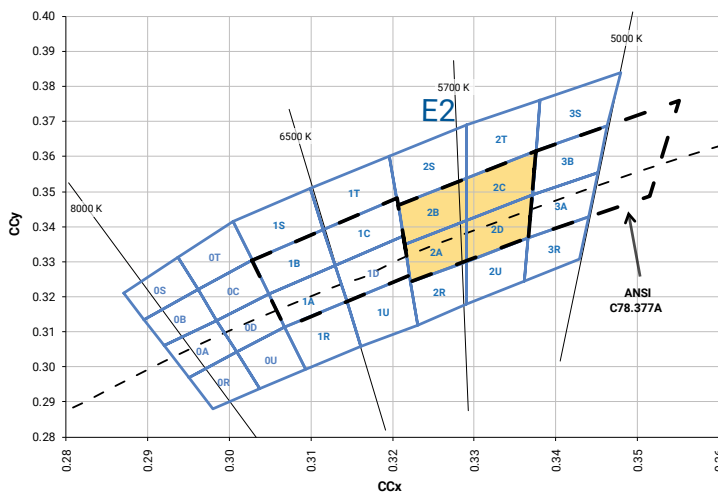
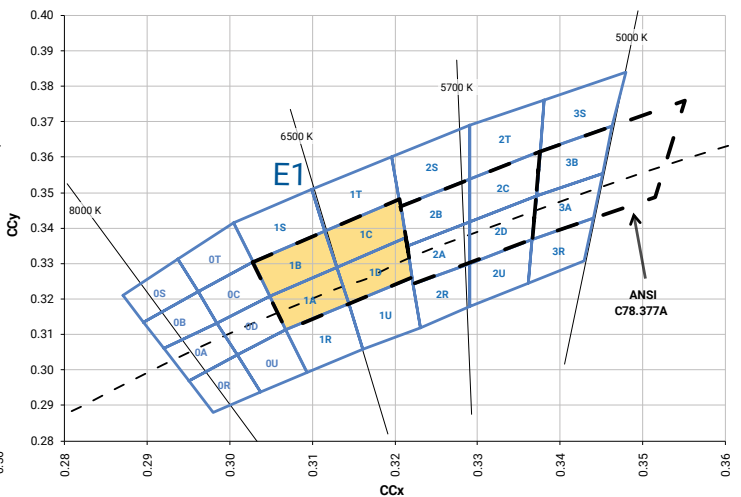
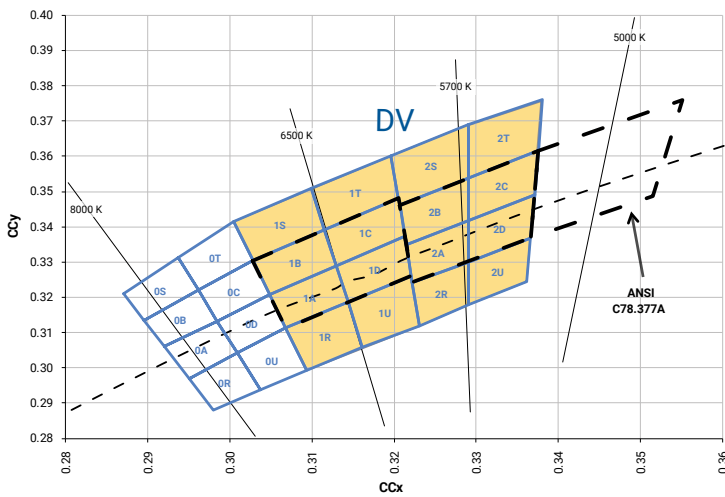
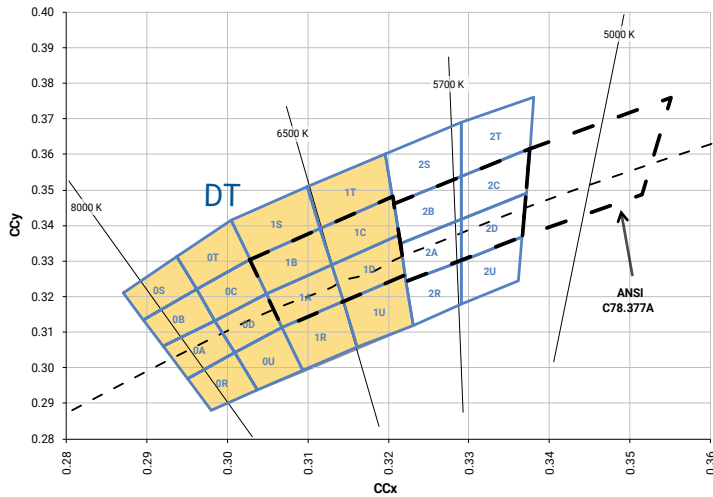

STANDARD WARM AND NEUTRAL WHITE KITS PLOTTED ON ANSI STANDARD CHROMATICITY REGIONS

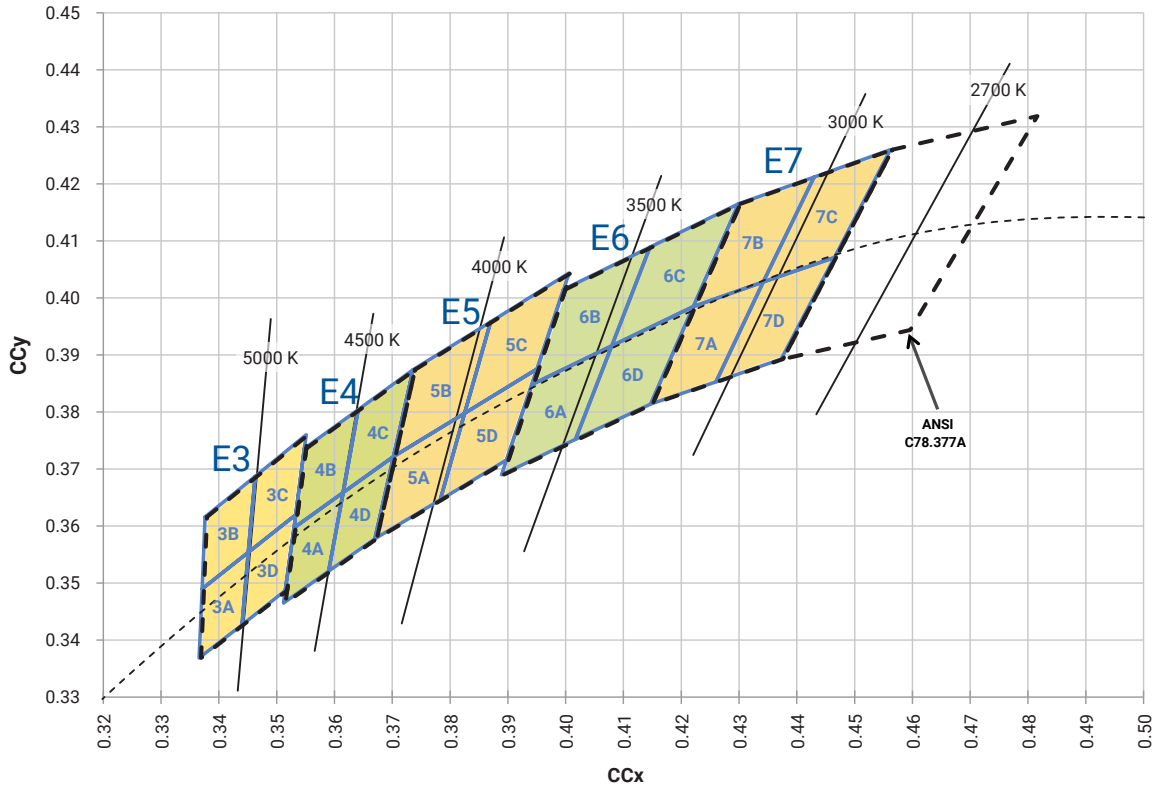

BIN AND ORDER-CODE FORMAT

Bin codes and order codes for XHP70.3 LEDs are configured in the following manner:

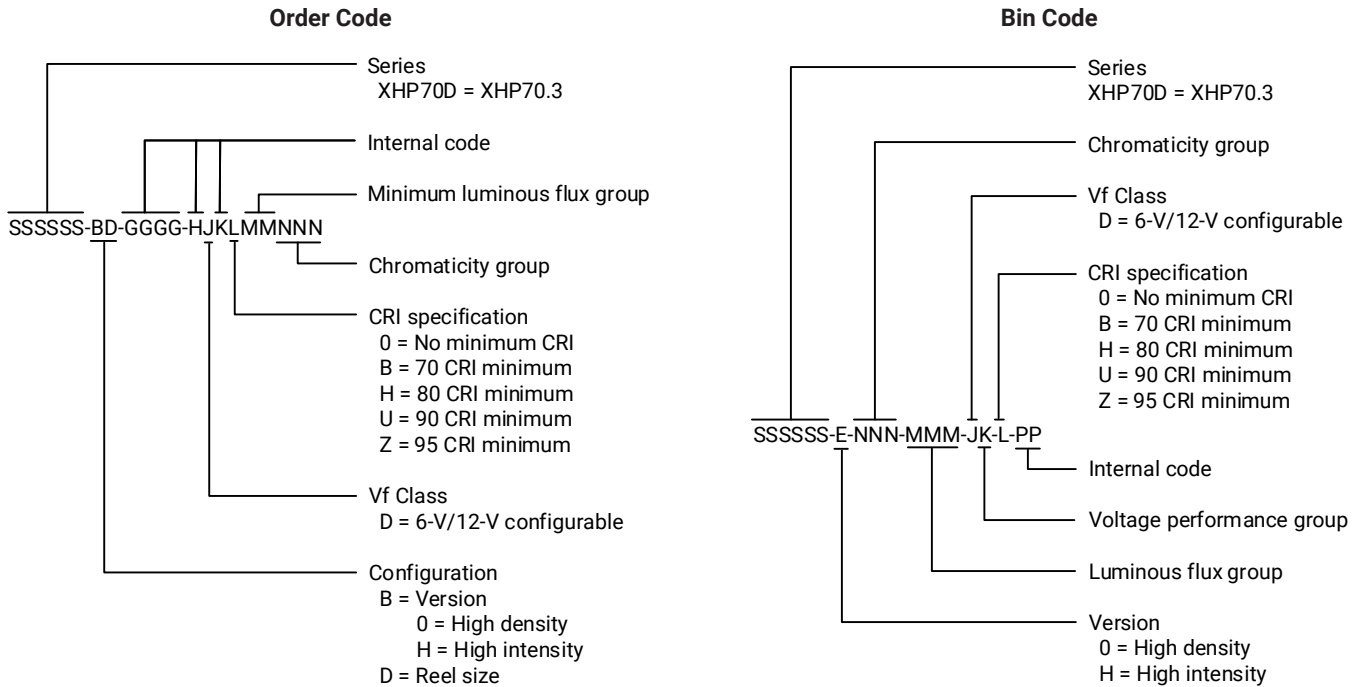

REFLOW SOLDERING CHARACTERISTICS

In testing, Cree LED has found XLamp XHP70.3 LEDs to be compatible with JEDEC J-STD-020C, using the parameters listed below. As a general guideline, Cree LED recommends that users follow the recommended soldering profile provided by the manufacturer of the solder paste used, and therefore it is the lamp or luminaire manufacturer’s responsibility to determine applicable soldering requirements.

Note that this general guideline may not apply to all PCB designs and configurations of reflow soldering equipment.

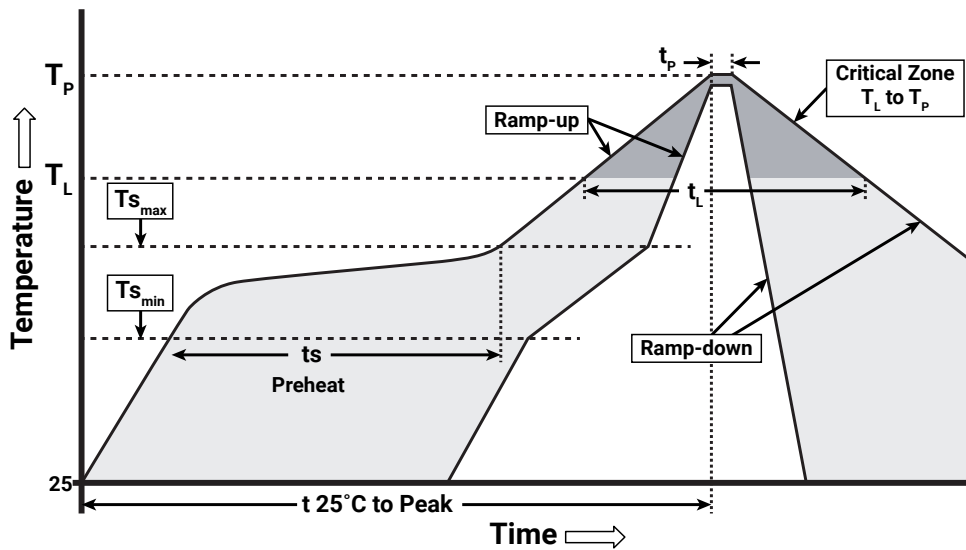

IPC/JEDEC J-STD-020C

| Profile Feature | Lead-Free Solder |
|---|------------------|
| Average Ramp-Up Rate ($T_{s_{max}}$ to T_p) | 1.2 °C/second |
| Preheat: Temperature Min ($T_{s_{min}}$) | 120 °C |
| Preheat: Temperature Max ($T_{s_{max}}$) | 170 °C |
| Preheat: Time ($t_{s_{min}}$ to $t_{s_{max}}$) | 65-150 seconds |
| Time Maintained Above: Temperature (T_L) | 217 °C |
| Time Maintained Above: Time (t_L) | 45-90 seconds |
| Peak/Classification Temperature (T_p) | 235 - 245 °C |
| Time Within 5 °C of Actual Peak Temperature (t_p) | 20-40 seconds |
| Ramp-Down Rate | 1 - 6 °C/second |
| Time 25 °C to Peak Temperature | 4 minutes max. |

Note: All temperatures refer to the topside of the package, measured on the package body surface.

NOTES

Measurements

The luminous flux, radiant power, chromaticity, forward voltage and CRI measurements in this document are binning specifications only and solely represent product measurements as of the date of shipment. These measurements will change over time based on a number of factors that are not within Cree LED's control and are not intended or provided as operational specifications for the products. Calculated values are provided for informational purposes only and are not intended or provided as specifications.

Pre-Release Qualification Testing

Please read the [LED Reliability Overview](#) for details of the qualification process Cree LED applies to ensure long-term reliability for XLamp LEDs and details of Cree LED's pre-release qualification testing for XLamp LEDs. Cree LED did not perform Room Temperature Operating Life (RTOL) testing on the XHP70.3 LED.

Lumen Maintenance

Cree LED now uses standardized IES LM-80-08 and TM-21-11 methods for collecting long-term data and extrapolating LED lumen maintenance. For information on the specific LM-80 data sets available for this LED, refer to the public [LM-80 results document](#).

Please read the [Long-Term Lumen Maintenance application note](#) for more details on Cree LED's lumen maintenance testing and forecasting. Please read the [Thermal Management application note](#) for details on how thermal design, ambient temperature, and drive current affect the LED junction temperature.

Moisture Sensitivity

Cree LED recommends keeping XLamp LEDs in the provided, resealable moisture-barrier packaging (MBP) until immediately prior to soldering. Unopened MBPs that contain XLamp LEDs do not need special storage for moisture sensitivity.

Once the MBP is opened, XLamp XHP70.3 LEDs may be stored as MSL 1 per JEDEC J-STD-033, meaning they have unlimited floor life in conditions of ≤ 30 °C/85% relative humidity (RH). Regardless of the storage condition, Cree LED recommends sealing any unsoldered LEDs in the original MBP.

RoHS Compliance

The levels of RoHS restricted materials in this product are below the maximum concentration values (also referred to as the threshold limits) permitted for such substances, or are used in an exempted application, in accordance with EU Directive 2011/65/EC (RoHS2), as implemented January 2, 2013. RoHS Declarations for this product can be obtained from your Cree LED representative or from the [Product Ecology](#) section of the Cree LED website.

REACH Compliance

REACH substances of very high concern (SVHCs) information is available for this product. Since the European Chemical Agency (ECHA) has published notice of their intent to frequently revise the SVHC listing for the foreseeable future, please contact a Cree LED representative to insure you get the most up-to-date REACH SVHC Declaration. REACH banned substance information (REACH Article 67) is also available upon request.

NOTES - CONTINUED

UL® Recognized Component

This product meets the requirements to be considered a UL Recognized Component with Level 4 enclosure consideration. The LED package or a portion thereof has been investigated as a fire and electrical enclosure per ANSI/UL 8750.

Vision Advisory

WARNING: Do not look at an exposed lamp in operation. Eye injury can result. For more information about LEDs and eye safety, please refer to the [LED Eye Safety application note](#).

MECHANICAL DIMENSIONS

Thermal vias, if present, are not shown on these drawings.

All dimensions are ± 0.13 mm unless otherwise indicated.

XHP70.3 High Density

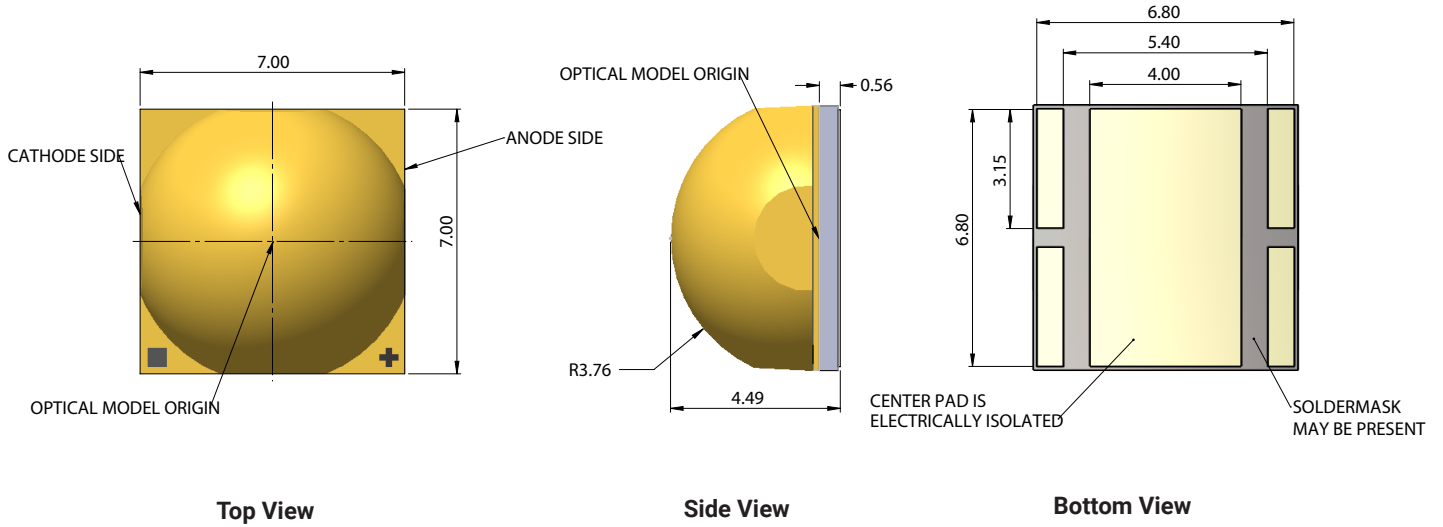

XHP70.3 High Intensity

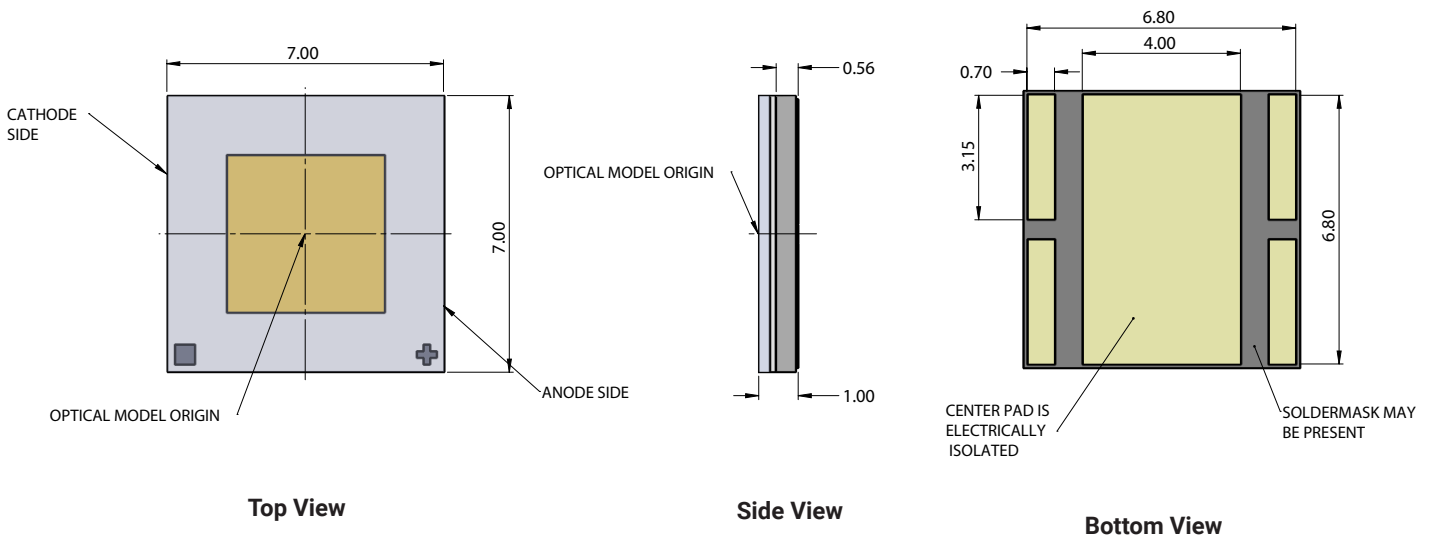

MECHANICAL DIMENSIONS - CONTINUED

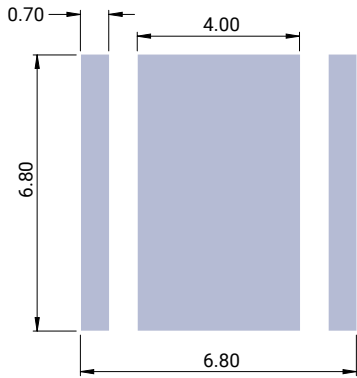

Recommended 6-V PCB Footprint
(center pad is electrically isolated)

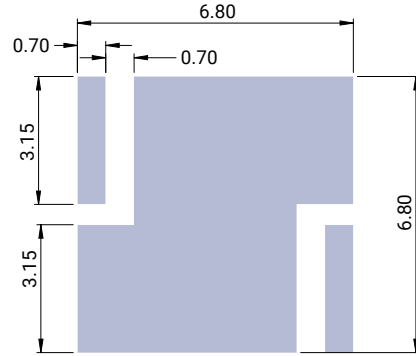

Recommended 12-V PCB Footprint
(center pad is connected to anode and cathode and is not electrically isolated)

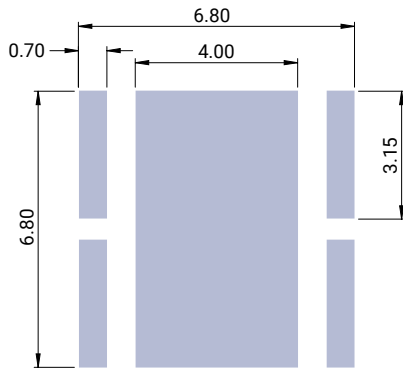

Recommended 6-V & 12-V PCB Solder Mask Opening
(solid area is open)

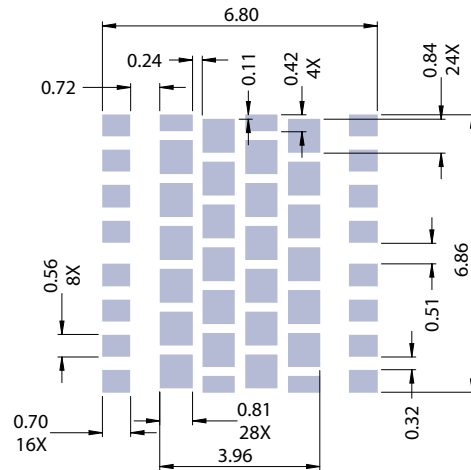

Recommended Stencil Openings
6 V & 12 V Configurations
(solid area is open)

ELECTRICAL CONFIGURATION

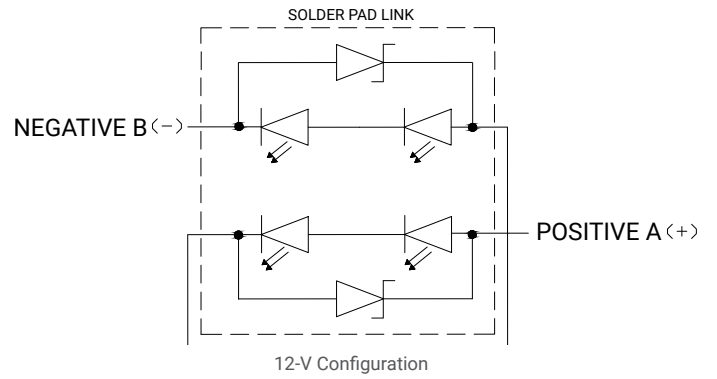
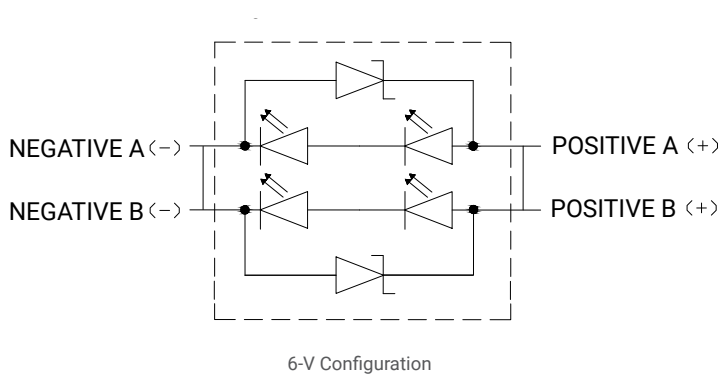

TAPE AND REEL

All Cree LED carrier tapes conform to EIA-481D, Automated Component Handling Systems Standard.

All dimensions are ±.13 mm unless otherwise indicated.

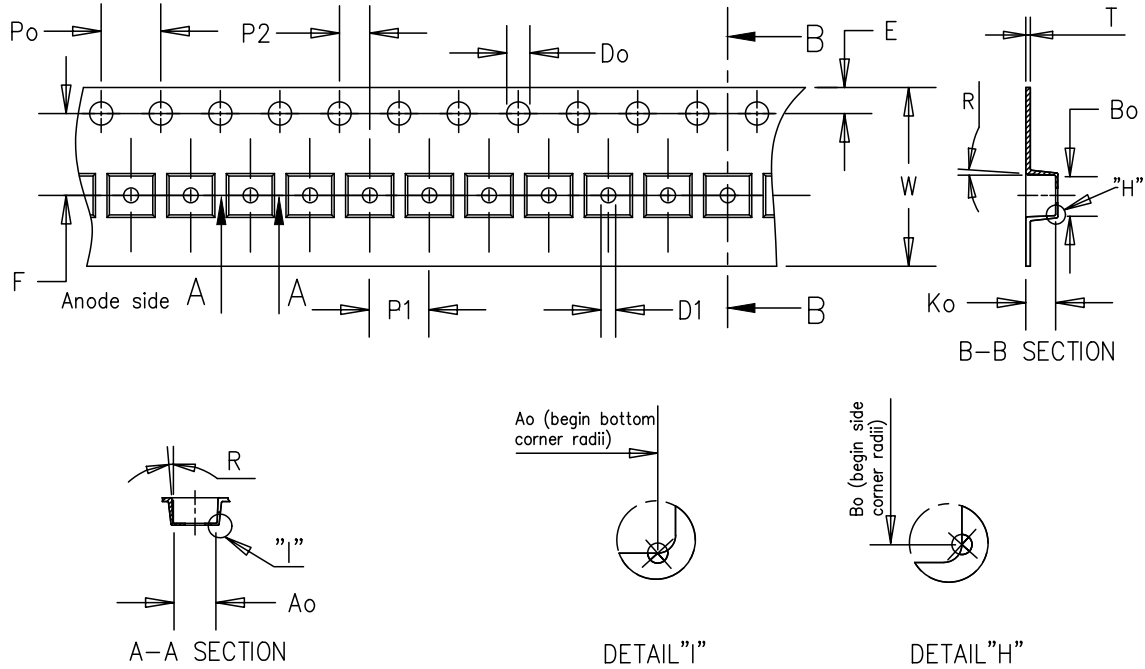

XHP70.3 High Density

| Item | Ao | Bo | Ko | Po | P1 | P2 | T | E | F | Do | D1 | W | R |
|------|------|------|------|------|-------|------|------|------|------|------|------|-------|----|
| Dim. | 7.40 | 7.40 | 4.60 | 4.00 | 12.00 | 2.00 | 0.36 | 1.75 | 7.50 | 1.50 | 1.50 | 16.00 | 5° |

XHP70.3 High Intensity

| Item | Ao | Bo | Ko | Po | P1 | P2 | T | E | F | Do | D1 | W | R |
|------|------|------|------|------|-------|------|------|------|------|------|------|-------|----|
| Dim. | 7.60 | 7.60 | 1.70 | 4.00 | 12.00 | 2.00 | 0.30 | 1.75 | 7.50 | 1.50 | 1.50 | 16.00 | 3° |

TAPE AND REEL - CONTINUED

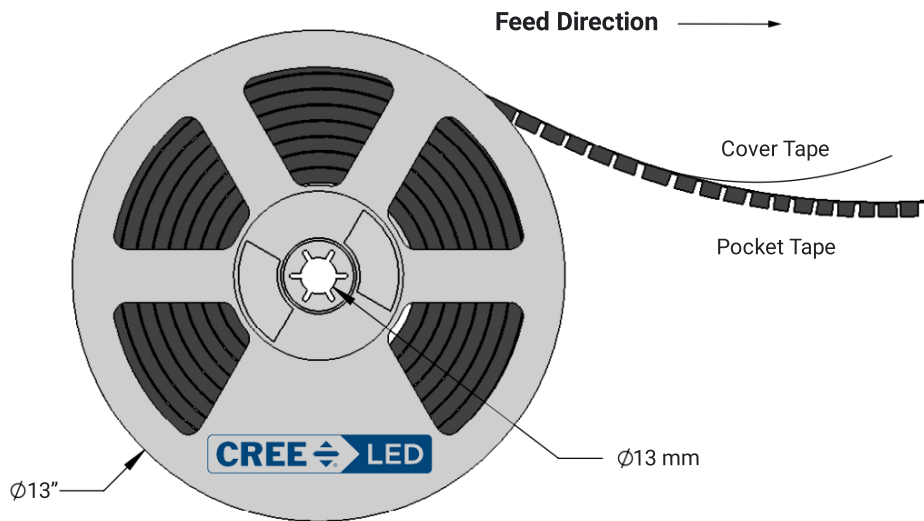
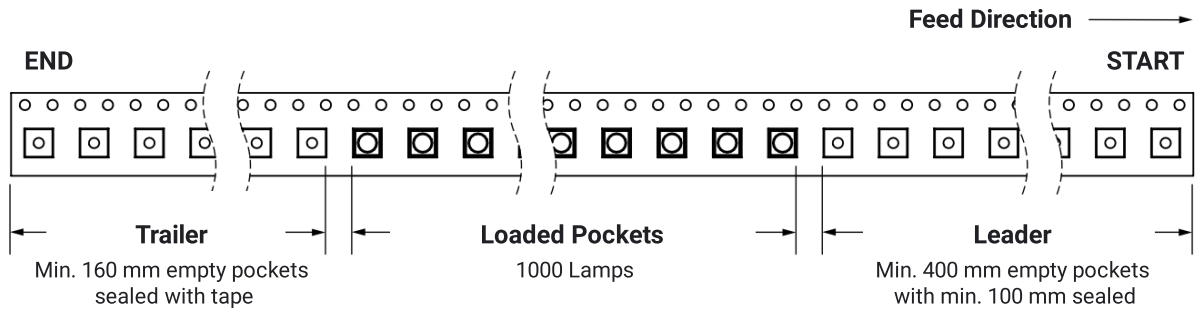

PACKAGING

Unpackaged Reel

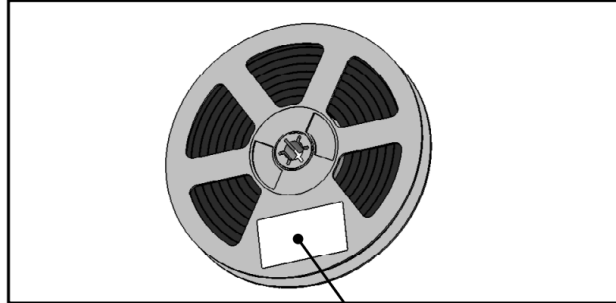

Label with Cree LED Bin Code, Quantity, Reel ID

Packaged Reel

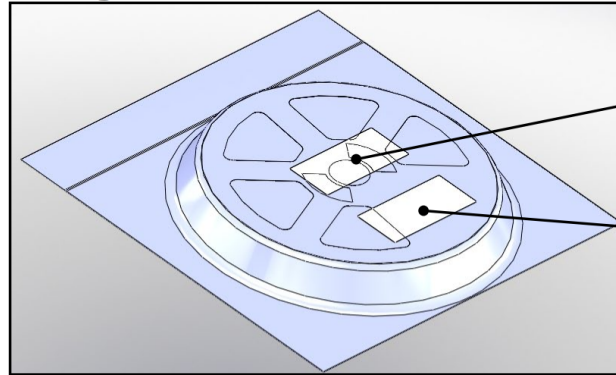

Label with Cree LED Order Code, Quantity, Reel ID, PO#

Label with Cree LED Bin Code, Quantity, Reel ID

Boxed Reel

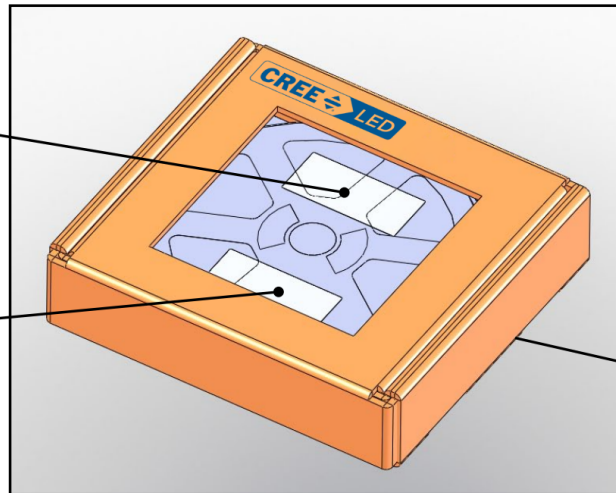

Label with Cree LED Order Code, Quantity, Reel ID, PO#

Label with Cree LED Bin Code, Quantity, Reel ID

Patent Label (on bottom of box)