

REVISIONS					
REV	ECO	DESCRIPTION	DATE	BY	APPR
A3	-	RELEASE NEW DWG FORMAT	11EC13	DRP	-

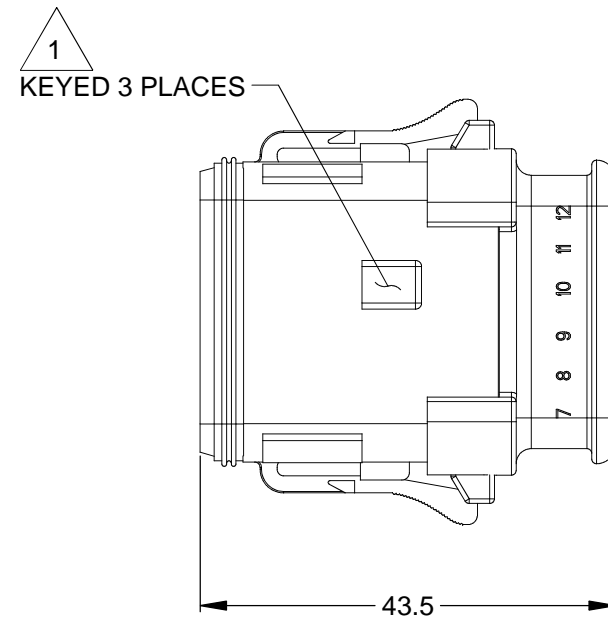

STRAIN RELIEF END CAP - BLACK - ALL CONNECTORS

1 REFER TO SHEET 2 FOR AVAILABLE CONNECTOR HOUSING COLORS

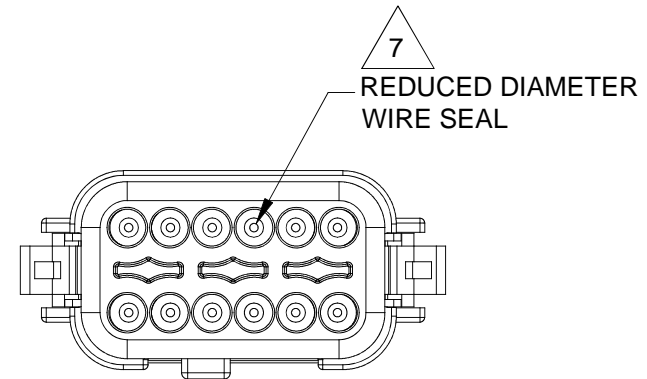
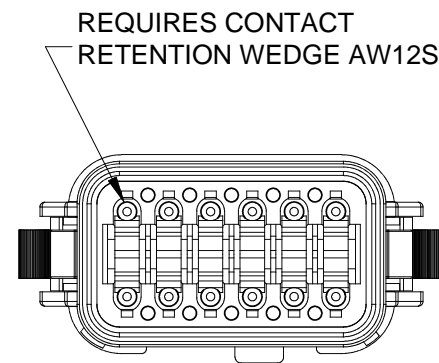
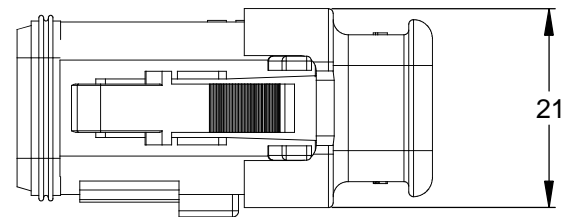
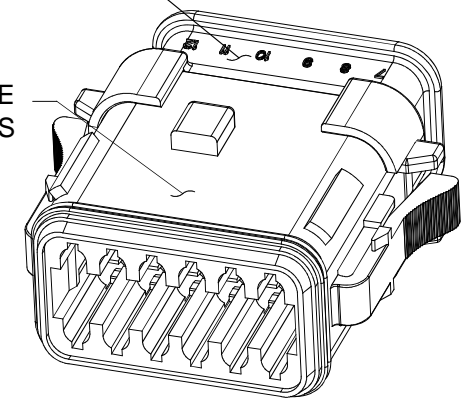

NOTES: UNLESS OTHERWISE SPECIFIED

1 SEE SHEET 2 FOR KEY ARRANGEMENTS AND COLORS.

2. MATERIAL:  
HOUSING: THERMOPLASTIC  
SEAL: SILICONE RUBBER

3. MODIFICATIONS: STRAIN RELIEF END CAP;  
REDUCED DIA. WIRE SEAL

4. SPECIFICATIONS:  
4.1 CURRENT RATING: 13 AMPS  
4.2 OPERATING TEMPERATURE: -55°C TO +125°C  
4.3 DIELECTRIC WITHSTANDING VOLTAGE: LESS THAN 2 MILLIAMPS CURRENT LEAKAGE @ 1500 VOLTS AC.  
4.4 INSULATION RESISTANCE: 1000 MEGOHMS MIN @ 25°C.  
4.5 MOISTURE RESISTANCE: IP67 ( MATED CONDITION )  
4.6 MATING CYCLE DURABILITY: 100 CYCLES  
4.7 RoHS COMPLIANT

5. MATING PART: AT04-12PX\* RECEPTACLE  
( X = A,B,C,D KEYS; \* = MODIFICATIONS AND COLORS )

6. ALL DIMENSIONS ARE FOR REFERENCE USE ONLY.

7 CONTACT SIZE AND REAR SEAL WIRE RANGE:

CONTACT SIZE	MIN. INSUL O.D.	MAX. INSUL O.D.	TYPICAL WIRE RANGE
16	1.35 mm (.053 in)	3.05 mm (.120 in)	14 - 20 AWG

QUANTITY	SEE SHEET 2 PART NUMBER	DESCRIPTION	ITEM								
<b>MATERIALS LIST</b>											
UNLESS OTHERWISE SPECIFIED 1) All dimensions are in metric(mm). 2) Tolerances are as follows: 1 PL DEC ±0.30 2 PL DEC ±0.15 3 PL DEC ±0.08 Fractions ±1/64 Angles ±1° 3) Note reference = X		SIGNATURES DRAWN: D.PARKS CHECKED: ENGINEER: APPROVAL:	DATE 11DEC13								
MATERIAL SPECIFICATIONS:		<p style="text-align: center;"><b>Amphenol</b></p> <p style="text-align: center;">Sine Systems - www.amphenol-sine.com 44724 Morley Drive Clinton Township, MI 48036</p> <p style="text-align: center;"><b>PLUG,12 SOCKET,AT SERIES,KEYED,STRAIN RELIEF END CAP, REDUCED DIA SEAL</b></p>									
PROCESS SPECIFICATIONS:											
NEXT ASSY:	THIS DRAWING IS SUPPLIED FOR INFORMATION ONLY. DESIGN FEATURES, SPECIFICATIONS AND PERFORMANCE DATA SHOWN HEREON ARE THE PROPERTY OF THE AMPHENOL CORPORATION. NO RIGHTS OF REPRODUCTION ARE IMPLIED. ALL DIMENSIONS ARE SUBJECT TO NORMAL MANUFACTURING VARIATIONS.	CUSTOMER:	<table border="1"> <tr> <td>SIZE</td> <td>TYPE</td> <td>DWG NO.</td> <td>REVISION</td> </tr> <tr> <td><b>B</b></td> <td><b>C-</b></td> <td><b>AT06-12SX-SR2XX</b></td> <td><b>A3</b></td> </tr> </table>	SIZE	TYPE	DWG NO.	REVISION	<b>B</b>	<b>C-</b>	<b>AT06-12SX-SR2XX</b>	<b>A3</b>
SIZE	TYPE	DWG NO.	REVISION								
<b>B</b>	<b>C-</b>	<b>AT06-12SX-SR2XX</b>	<b>A3</b>								
SCALE: NONE		SHEET 1 OF 2									

TITLE: PLUG, 12 POS, AT, KEYED, STRAIN RELIEF, REDUCED DIA SEAL  
DWG NO.: AT06-12SX-SR2XX  
REV: A3  
SH: 1  
OF: 2

REVISIONS					
REV	ECO	DESCRIPTION	DATE	BY	APPR

P/N AT06-12SA-SR2GY  
KEY-A CONFIGURATION  
STANDARD COLOR: GREY

P/N AT06-12SB-SR2BK  
KEY-B CONFIGURATION  
STANDARD COLOR: BLACK

P/N AT06-12SC-SR2GN  
KEY-C CONFIGURATION  
STANDARD COLOR: GREEN

P/N AT06-12SD-SR2BR  
KEY-D CONFIGURATION  
STANDARD COLOR: BROWN

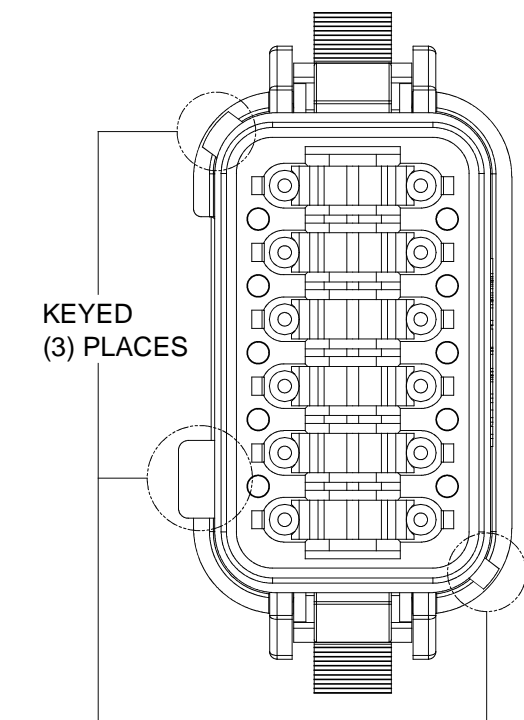
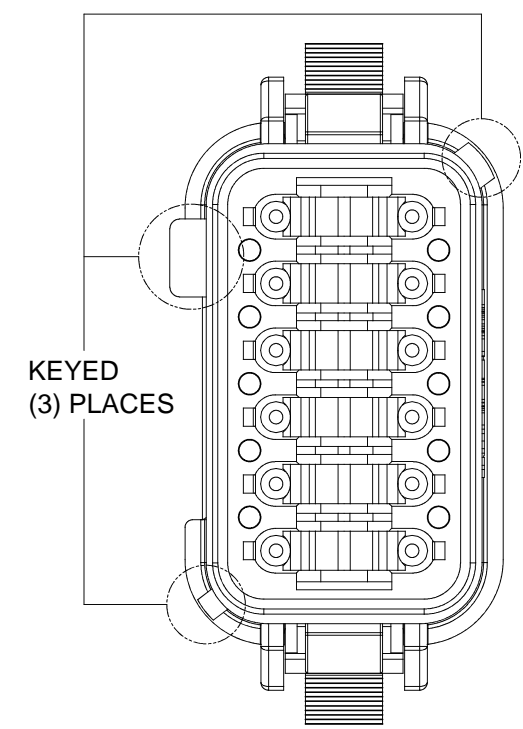
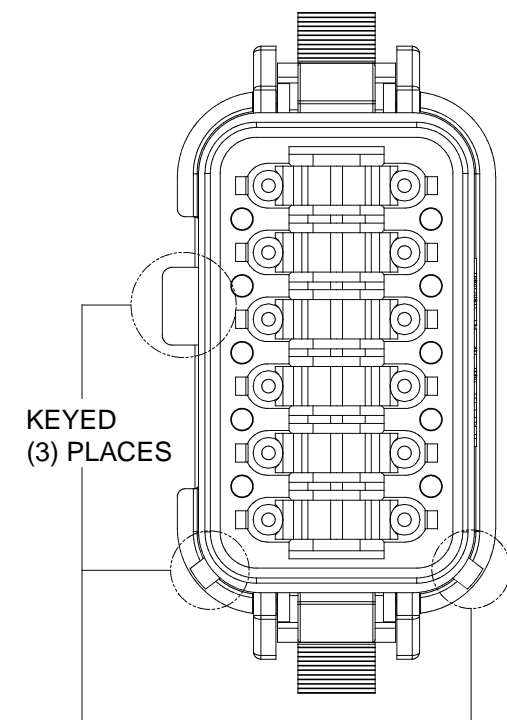
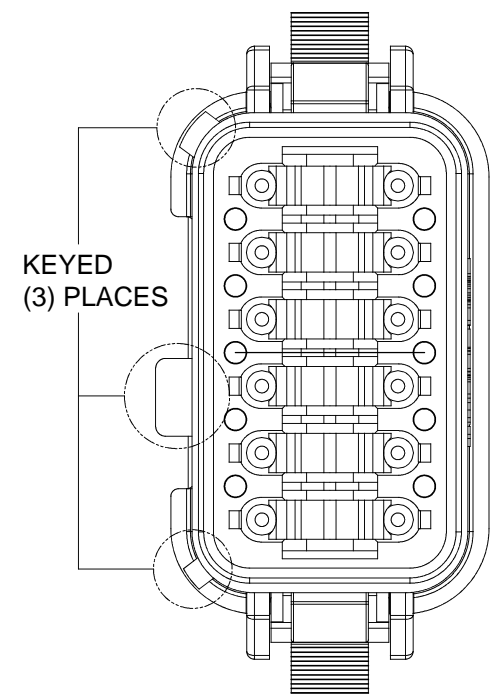

KEY-A CONFIGURATION	
COLOR	PART NUMBER
<b>* GREY</b>	<b>AT06-12SA-SR2GY</b>
BLACK	AT06-12SA-SR2BK
GREEN	AT06-12SA-SR2GN
BROWN	AT06-12SA-SR2BR

KEY-B CONFIGURATION	
COLOR	PART NUMBER
GREY	AT06-12SB-SR2GY
<b>* BLACK</b>	<b>AT06-12SB-SR2BK</b>
GREEN	AT06-12SB-SR2GN
BROWN	AT06-12SB-SR2BR

KEY-C CONFIGURATION	
COLOR	PART NUMBER
GREY	AT06-12SC-SR2GY
BLACK	AT06-12SC-SR2BK
<b>* GREEN</b>	<b>AT06-12SC-SR2GN</b>
BROWN	AT06-12SC-SR2BR

KEY-D CONFIGURATION	
COLOR	PART NUMBER
GREY	AT06-12SD-SR2GY
BLACK	AT06-12SD-SR2BK
GREEN	AT06-12SD-SR2GN
<b>* BROWN</b>	<b>AT06-12SD-SR2BR</b>

NOTE:

AN ASTERISKS ( \* ) PLACED BEFORE THE COLOR DENOTES THE STANDARD MOLDED COLOR OF THE CONNECTORS SHOWN ABOVE. STRAIN RELIEF END CAPS ARE AVAILABLE IN BLACK ONLY.

OTHER COLORS SHOWN ARE AVAILABLE VIA SPECIAL ORDER.

TITLE: PLUG, 12 POS, AT, KEYED, STRAIN RELIEF, REDUCED DIA SEAL  
DWG NO: AT06-12SX-SR2XX  
REV: A3  
SH: 2  
OF: 2

QUANTITY	PART NUMBER	DESCRIPTION	ITEM										
<b>MATERIALS LIST</b>													
UNLESS OTHERWISE SPECIFIED 1) All dimensions are in metric (mm). 2) Tolerances are as follows: 1 PL DEC ±0.30 2 PL DEC ±0.15 3 PL DEC ±0.08 Fractions ±1/64 Angles ±1° 3) Note reference =		<table border="1"> <tr> <th>SIGNATURES</th> <th>DATE</th> </tr> <tr> <td>D.PARKS</td> <td>11DEC13</td> </tr> <tr> <td>CHECKED:</td> <td></td> </tr> <tr> <td>ENGINEER:</td> <td></td> </tr> <tr> <td>APPROVAL:</td> <td></td> </tr> </table>		SIGNATURES	DATE	D.PARKS	11DEC13	CHECKED:		ENGINEER:		APPROVAL:	
SIGNATURES	DATE												
D.PARKS	11DEC13												
CHECKED:													
ENGINEER:													
APPROVAL:													
MATERIAL SPECIFICATIONS:		<p style="text-align: center;"><b>Amphenol</b></p> <p style="text-align: center;">Sine Systems - www.amphenol-sine.com 44724 Morley Drive Clinton Township, MI 48036</p>											
PROCESS SPECIFICATIONS:		<p style="text-align: center;">PLUG, 12 SOCKET, AT SERIES, KEYED, STRAIN RELIEF END CAP, REDUCED DIA SEAL</p>											
NEXT ASSY:		<table border="1"> <tr> <td>THIS DRAWING IS SUPPLIED FOR INFORMATION ONLY. DESIGN FEATURES, SPECIFICATIONS AND PERFORMANCE DATA SHOWN HEREON ARE THE PROPERTY OF THE AMPHENOL CORPORATION. NO RIGHTS OF REPRODUCTION ARE IMPLIED. ALL DIMENSIONS ARE SUBJECT TO NORMAL MANUFACTURING VARIATIONS.</td> <td>SIZE: <b>B C-</b></td> <td>DWG NO: <b>AT06-12SX-SR2XX</b></td> <td>REVISION: <b>A3</b></td> </tr> <tr> <td>SCALE: <b>NONE</b></td> <td colspan="2">SHEET <b>2</b> OF <b>2</b></td> <td></td> </tr> </table>		THIS DRAWING IS SUPPLIED FOR INFORMATION ONLY. DESIGN FEATURES, SPECIFICATIONS AND PERFORMANCE DATA SHOWN HEREON ARE THE PROPERTY OF THE AMPHENOL CORPORATION. NO RIGHTS OF REPRODUCTION ARE IMPLIED. ALL DIMENSIONS ARE SUBJECT TO NORMAL MANUFACTURING VARIATIONS.	SIZE: <b>B C-</b>	DWG NO: <b>AT06-12SX-SR2XX</b>	REVISION: <b>A3</b>	SCALE: <b>NONE</b>	SHEET <b>2</b> OF <b>2</b>				
THIS DRAWING IS SUPPLIED FOR INFORMATION ONLY. DESIGN FEATURES, SPECIFICATIONS AND PERFORMANCE DATA SHOWN HEREON ARE THE PROPERTY OF THE AMPHENOL CORPORATION. NO RIGHTS OF REPRODUCTION ARE IMPLIED. ALL DIMENSIONS ARE SUBJECT TO NORMAL MANUFACTURING VARIATIONS.	SIZE: <b>B C-</b>	DWG NO: <b>AT06-12SX-SR2XX</b>	REVISION: <b>A3</b>										
SCALE: <b>NONE</b>	SHEET <b>2</b> OF <b>2</b>												

# A Series™ - Contact Size 16 Options (Works with: AT, ATV, AHD-9, ARC, DuraMate and PanelMate Series)

Machined Contacts, Sockets & Pins				
Part Number	Description	Size	AWG	Type
AT60-215-1631	Male Contact - Pin, Gold-plated	16	14	Machined
AT62-209-1631	Female Contact - Socket, Gold-plated	16	14	Machined
AT60-215-16141	Male Contact - Pin, Nickel-plated	16	14	Machined
AT62-209-16141	Female Contact - Socket, Nickel-plated	16	14	Machined
AT60-202-1631	Male Contact - Pin, Gold-plated	16	16-20	Machined
AT62-201-1631	Female Contact - Socket, Gold-plated	16	16-20	Machined
AT60-202-16141	Male Contact - Pin, Nickel-plated	16	16-20	Machined
AT62-201-16141	Female Contact - Socket, Nickel-plated	16	16-20	Machined
AT60-202-1631-22	Male Contact - Pin, Gold-plated	16	22-24	Machined
AT62-201-1631-22	Female Contact - Socket, Gold-plated	16	22-24	Machined
AT60-202-16141-22	Male Contact - Pin, Nickel-plated	16	22-24	Machined
AT62-201-16141-22	Female Contact - Socket, Nickel-plated	16	22-24	Machined

Tooling - Machined Contacts	
Part Number	Description
AUTK-16	Hand Crimp Tool, Size 16
AUTK-100	Universal Heavy Duty Contact Crimping Tool Kit, Size 12/16/20
CA-5D12	Universal Hand Crimp Tool, Size 12/16/20
CA-5E12	Pneumatic Crimp Tool, Size 12/16/20

Contact Removal Tools (For both Machined or Stamped & Formed Contacts)	
Part Number	Description
ATRT-100	Contact and Wedgelock Extraction Tool
AT11-310-1605	Contact Removal Tool, Plastic, Size 16

Sealing Plugs (For both Machined or Stamped & Formed Contacts)	
Part Number	Description
A114017	Sealing Plug, Size 16, White
A114017-SR	Sealing Plug, Size 16, SR01 Series, Black
AT13-217-1605	Locking Sealing Plug, Size 16, Grey
AT13-217-1605-SR	Locking Sealing Plug, Size 16, SR01 Series, Red

Stamped & Formed Contacts, Sockets & Pins				
Part Number	Description	Size	AWG	Type
AT60-14-0122	Male Contact - Pin, Nickel-plated	16	14-18	Stamped & Formed
AT62-14-0122	Female Contact - Socket, Nickel-plated	16	14-18	Stamped & Formed
AT60-14-0144	Male Contact - Pin, Gold-plated	16	14-18	Stamped & Formed
AT62-14-0144	Female Contact - Socket, Gold-plated	16	14-18	Stamped & Formed
AT60-16-0122	Male Contact - Pin, Nickel-plated	16	16-18	Stamped & Formed
AT62-16-0122	Female Contact - Socket, Nickel-plated	16	16-18	Stamped & Formed
AT60-16-0144	Male Contact - Pin, Gold-plated	16	16-18	Stamped & Formed
AT62-16-0144	Female Contact - Socket, Gold-plated	16	16-18	Stamped & Formed
AT60-16-0622	Male Contact - Pin, Nickel-plated	16	16-20	Stamped & Formed
AT62-16-0622	Female Contact - Socket, Nickel-plated	16	16-20	Stamped & Formed
AT60-16-0644	Male Contact - Pin, Gold-plated	16	16-20	Stamped & Formed
AT62-16-0644	Female Contact - Socket, Gold-plated	16	16-20	Stamped & Formed
AT60-16-0677	Male Contact - Pin, Tin-plated	16	16-20	Stamped & Formed
AT62-16-0677	Female Contact - Socket, Tin-plated	16	16-20	Stamped & Formed
AT60-16-0822	Male Contact - Pin, Nickel-plated	16	20-22	Stamped & Formed
AT62-16-0822	Female Contact - Socket, Nickel-plated	16	20-22	Stamped & Formed
AT60-16-0844	Male Contact - Pin, Gold-plated	16	20-22	Stamped & Formed
AT62-16-0844	Female Contact - Socket, Gold-plated	16	20-22	Stamped & Formed

Tooling - Stamped & Formed Contacts	
MFX-3950	Crimp Die - Size 16, 18-20AWG
MFX-3953	Crimp Die - Size 16, 16-18AWG
MFX-3975	Crimp Die - Size 16, 14-16AWG
MFX-3990	Crimp Die - Size 16, 20-22AWG
ATT-16-00	Hand Crimp Tool - Size 16, 14-16AWG
ATT-16-01	Hand Crimp Tool - Size 16, 18-20AWG
ATT-1612-03	Hand Crimp Tool - Size 16, 20-22AWG