

OSRAM KW SITQA1.KD

Datasheet

Published by **ams-OSRAM AG**

Tobelbader Strasse 30, 8141 Premstaetten, Austria

Phone +43 3136 500-0

ams-osram.com

© All rights reserved



SYNIOS® E1515

KW SITQA1.KD

This compact LED device is specifically designed for LCD direct backlighting. Its batwing radiation profile and 360° emission enable low profile, homogeneous backlights. The spectral properties are optimized for high color gamut displays.



Applications

- Display Backlighting

Features

- Package: colored silicone resin, SMD epoxy package
- Chip technology: InGaN on Sapphire
- Color: $C_x = 0.28$, $C_y = 0.26$ acc. to CIE 1931 (● white)
- Corrosion Robustness Class: 2B
- Qualifications: AEC-Q102 Qualified
- ESD: 2 kV acc. to ANSI/ESDA/JEDEC JS-001 (HBM, Class 2)
- Unique design: It is strongly advised to apply the recommended solder pad design for a proper function of the LED.

Ordering Information

Type	Luminous Flux ¹⁾ $I_F = 15 \text{ mA}$ Φ_V	Ordering Code
KW SITQA1.KD-DUFQ-D25D144-HR-N464	6.58 ... 13.00 lm	Q65112A9210

Maximum Ratings

Parameter	Symbol		Values
Operating Temperature	T_{op}	min.	-40 °C
		max.	110 °C
Storage Temperature	T_{stg}	min.	-40 °C
		max.	110 °C
Junction Temperature	T_j	max.	125 °C
Forward current $T_s = 25\text{ °C}$	I_F	min.	1 mA
		max.	30 mA
Forward current pulsed $D = 25\%$; $T_s = 25\text{ °C}$	$I_{F\ pulse}$	max.	80 mA
Reverse voltage ²⁾ $T_s = 25\text{ °C}$	V_R	max.	10 V
ESD withstand voltage acc. to ANSI/ESDA/JEDEC JS-001 (HBM, Class 2)	V_{ESD}		2 kV

Characteristics

$I_F = 15 \text{ mA}$; $T_S = 25 \text{ °C}$

Parameter	Symbol		Values
Chromaticity Coordinate ³⁾	Cx	typ.	0.28
	Cy	typ.	0.26
Peak Wavelength $I_F = 15 \text{ mA}$	λ_{peak}	min.	446 nm
		max.	464 nm
Forward Voltage ⁴⁾ $I_F = 15 \text{ mA}$	V_F	min.	5.40 V
		typ.	5.85 V
		max.	6.40 V
Reverse current ²⁾ $V_R = 10 \text{ V}$	I_R	typ.	0.01 μA
		max.	10 μA
Real thermal resistance junction/solderpoint ⁵⁾	$R_{\text{thJS real}}$	typ.	125 K / W
		max.	195 K / W
Electrical thermal resistance junction/solderpoint ⁵⁾ with efficiency $\eta_e = 38 \%$	$R_{\text{thJS elec.}}$	typ.	78 K / W
		max.	121 K / W

Brightness Groups

Group	Luminous Flux ¹⁾ $I_F = 15 \text{ mA}$ min. Φ_V	Luminous Flux ¹⁾ $I_F = 15 \text{ mA}$ max. Φ_V
DU	6.58 lm	7.10 lm
EP	7.10 lm	7.63 lm
EQ	7.63 lm	8.20 lm
ER	8.20 lm	8.92 lm
ES	8.92 lm	9.70 lm
ET	9.70 lm	10.42 lm
EU	10.42 lm	11.20 lm
FP	11.20 lm	12.10 lm
FQ	12.10 lm	13.00 lm

Forward Voltage Groups

Group	Forward Voltage ⁴⁾ $I_F = 15 \text{ mA}$ min. V_F	Forward Voltage ⁴⁾ $I_F = 15 \text{ mA}$ max. V_F
N4	5.40 V	5.60 V
S4	5.60 V	5.80 V
W4	5.80 V	6.00 V
24	6.00 V	6.20 V
64	6.20 V	6.40 V

Wavelength Groups

Group	Peak Wavelength $I_F = 15 \text{ mA}$ min. λ_{peak}	Peak Wavelength $I_F = 15 \text{ mA}$ max. λ_{peak}
H	446 nm	448 nm
J	448 nm	450 nm
K	450 nm	452 nm
L	452 nm	454 nm
M	454 nm	456 nm

Wavelength Groups

Group	Peak Wavelength $I_F = 15 \text{ mA}$ min. λ_{peak}	Peak Wavelength $I_F = 15 \text{ mA}$ max. λ_{peak}
N	456 nm	458 nm
P	458 nm	460 nm
Q	460 nm	462 nm
R	462 nm	464 nm

Chromaticity Coordinate Groups

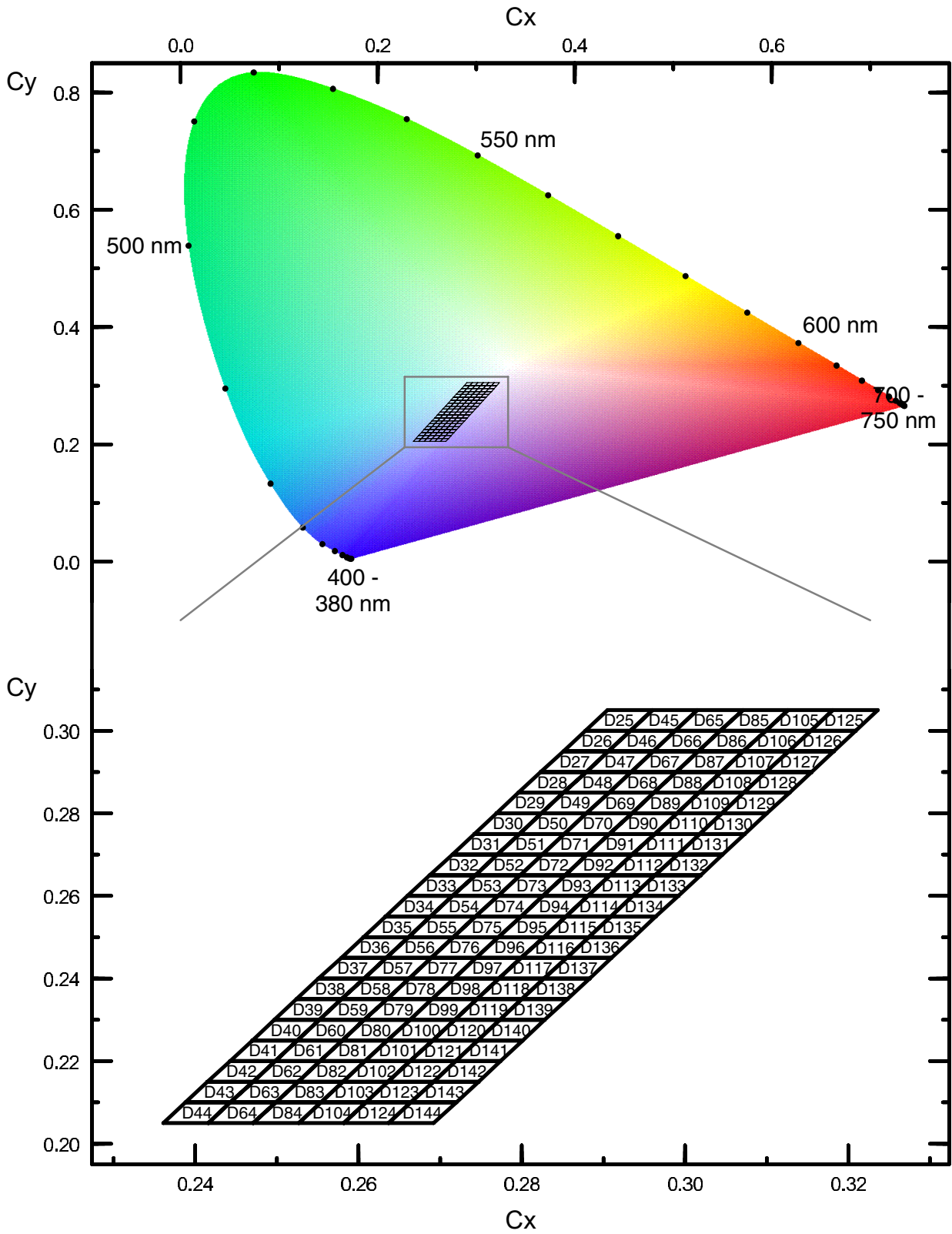

Chromaticity Coordinate Groups ³⁾

Group	Cx	Cy	Group	Cx	Cy	Group	Cx	Cy
D100	0.2635	0.2250	D108	0.3017	0.2850	D116	0.2799	0.2450
	0.2663	0.2300		0.3044	0.2900		0.2827	0.2500
	0.2718	0.2300		0.3099	0.2900		0.2882	0.2500
	0.2691	0.2250		0.3072	0.2850		0.2855	0.2450
D101	0.2608	0.2200	D109	0.2990	0.2800	D117	0.2772	0.2400
	0.2635	0.2250		0.3017	0.2850		0.2799	0.2450
	0.2691	0.2250		0.3072	0.2850		0.2855	0.2450
	0.2663	0.2200		0.3045	0.2800		0.2827	0.2400
D102	0.2581	0.2150	D110	0.2963	0.2750	D118	0.2745	0.2350
	0.2608	0.2200		0.2990	0.2800		0.2772	0.2400
	0.2663	0.2200		0.3045	0.2800		0.2827	0.2400
	0.2636	0.2150		0.3018	0.2750		0.2800	0.2350
D103	0.2554	0.2100	D111	0.2935	0.2700	D119	0.2718	0.2300
	0.2581	0.2150		0.2963	0.2750		0.2745	0.2350
	0.2636	0.2150		0.3018	0.2750		0.2800	0.2350
	0.2609	0.2100		0.2991	0.2700		0.2773	0.2300
D104	0.2527	0.2050	D112	0.2908	0.2650	D120	0.2691	0.2250
	0.2554	0.2100		0.2935	0.2700		0.2718	0.2300
	0.2609	0.2100		0.2991	0.2700		0.2773	0.2300
	0.2582	0.2050		0.2963	0.2650		0.2746	0.2250
D105	0.3099	0.3000	D113	0.2881	0.2600	D121	0.2663	0.2200
	0.3126	0.3050		0.2908	0.2650		0.2691	0.2250
	0.3181	0.3050		0.2963	0.2650		0.2746	0.2250
	0.3154	0.3000		0.2936	0.2600		0.2719	0.2200
D106	0.3071	0.2950	D114	0.2854	0.2550	D122	0.2636	0.2150
	0.3099	0.3000		0.2881	0.2600		0.2663	0.2200
	0.3154	0.3000		0.2936	0.2600		0.2719	0.2200
	0.3127	0.2950		0.2909	0.2550		0.2692	0.2150
D107	0.3044	0.2900	D115	0.2827	0.2500	D123	0.2609	0.2100
	0.3071	0.2950		0.2854	0.2550		0.2636	0.2150
	0.3127	0.2950		0.2909	0.2550		0.2692	0.2150
	0.3099	0.2900		0.2882	0.2500		0.2664	0.2100

Group	Cx	Cy	Group	Cx	Cy	Group	Cx	Cy
D124	0.2582	0.2050	D132	0.2963	0.2650	D140	0.2746	0.2250
	0.2609	0.2100		0.2991	0.2700		0.2773	0.2300
	0.2664	0.2100		0.3046	0.2700		0.2828	0.2300
	0.2637	0.2050		0.3019	0.2650		0.2801	0.2250
D125	0.3154	0.3000	D133	0.2936	0.2600	D141	0.2719	0.2200
	0.3181	0.3050		0.2963	0.2650		0.2746	0.2250
	0.3236	0.3050		0.3019	0.2650		0.2801	0.2250
	0.3209	0.3000		0.2992	0.2600		0.2774	0.2200
D126	0.3127	0.2950	D134	0.2909	0.2550	D142	0.2692	0.2150
	0.3154	0.3000		0.2936	0.2600		0.2719	0.2200
	0.3209	0.3000		0.2992	0.2600		0.2774	0.2200
	0.3182	0.2950		0.2964	0.2550		0.2747	0.2150
D127	0.3099	0.2900	D135	0.2882	0.2500	D143	0.2664	0.2100
	0.3127	0.2950		0.2909	0.2550		0.2692	0.2150
	0.3182	0.2950		0.2964	0.2550		0.2747	0.2150
	0.3155	0.2900		0.2937	0.2500		0.2720	0.2100
D128	0.3072	0.2850	D136	0.2855	0.2450	D144	0.2637	0.2050
	0.3099	0.2900		0.2882	0.2500		0.2664	0.2100
	0.3155	0.2900		0.2937	0.2500		0.2720	0.2100
	0.3128	0.2850		0.2910	0.2450		0.2692	0.2050
D129	0.3045	0.2800	D137	0.2827	0.2400	D25	0.2878	0.3000
	0.3072	0.2850		0.2855	0.2450		0.2905	0.3050
	0.3128	0.2850		0.2910	0.2450		0.2960	0.3050
	0.3100	0.2800		0.2883	0.2400		0.2933	0.3000
D130	0.3018	0.2750	D138	0.2800	0.2350	D26	0.2851	0.2950
	0.3045	0.2800		0.2827	0.2400		0.2878	0.3000
	0.3100	0.2800		0.2883	0.2400		0.2933	0.3000
	0.3073	0.2750		0.2856	0.2350		0.2906	0.2950
D131	0.2991	0.2700	D139	0.2773	0.2300	D27	0.2823	0.2900
	0.3018	0.2750		0.2800	0.2350		0.2851	0.2950
	0.3073	0.2750		0.2856	0.2350		0.2906	0.2950
	0.3046	0.2700		0.2828	0.2300		0.2879	0.2900

Group	Cx	Cy	Group	Cx	Cy	Group	Cx	Cy
D28	0.2796	0.2850	D36	0.2579	0.2450	D44	0.2361	0.2050
	0.2823	0.2900		0.2606	0.2500		0.2388	0.2100
	0.2879	0.2900		0.2661	0.2500		0.2443	0.2100
	0.2851	0.2850		0.2634	0.2450		0.2416	0.2050
D29	0.2769	0.2800	D37	0.2551	0.2400	D45	0.2933	0.3000
	0.2796	0.2850		0.2579	0.2450		0.2960	0.3050
	0.2851	0.2850		0.2634	0.2450		0.3015	0.3050
	0.2824	0.2800		0.2607	0.2400		0.2988	0.3000
D30	0.2742	0.2750	D38	0.2524	0.2350	D46	0.2906	0.2950
	0.2769	0.2800		0.2551	0.2400		0.2933	0.3000
	0.2824	0.2800		0.2607	0.2400		0.2988	0.3000
	0.2797	0.2750		0.2579	0.2350		0.2961	0.2950
D31	0.2715	0.2700	D39	0.2497	0.2300	D47	0.2879	0.2900
	0.2742	0.2750		0.2524	0.2350		0.2906	0.2950
	0.2797	0.2750		0.2579	0.2350		0.2961	0.2950
	0.2770	0.2700		0.2552	0.2300		0.2934	0.2900
D32	0.2687	0.2650	D40	0.2470	0.2250	D48	0.2851	0.2850
	0.2715	0.2700		0.2497	0.2300		0.2879	0.2900
	0.2770	0.2700		0.2552	0.2300		0.2934	0.2900
	0.2743	0.2650		0.2525	0.2250		0.2907	0.2850
D33	0.2660	0.2600	D41	0.2443	0.2200	D49	0.2824	0.2800
	0.2687	0.2650		0.2470	0.2250		0.2851	0.2850
	0.2743	0.2650		0.2525	0.2250		0.2907	0.2850
	0.2715	0.2600		0.2498	0.2200		0.2879	0.2800
D34	0.2633	0.2550	D42	0.2415	0.2150	D50	0.2797	0.2750
	0.2660	0.2600		0.2443	0.2200		0.2824	0.2800
	0.2715	0.2600		0.2498	0.2200		0.2879	0.2800
	0.2688	0.2550		0.2471	0.2150		0.2852	0.2750
D35	0.2606	0.2500	D43	0.2388	0.2100	D51	0.2770	0.2700
	0.2633	0.2550		0.2415	0.2150		0.2797	0.2750
	0.2688	0.2550		0.2471	0.2150		0.2852	0.2750
	0.2661	0.2500		0.2443	0.2100		0.2825	0.2700

Group	Cx	Cy	Group	Cx	Cy	Group	Cx	Cy
D52	0.2743	0.2650	D60	0.2525	0.2250	D68	0.2907	0.2850
	0.2770	0.2700		0.2552	0.2300		0.2934	0.2900
	0.2825	0.2700		0.2607	0.2300		0.2989	0.2900
	0.2798	0.2650		0.2580	0.2250		0.2962	0.2850
D53	0.2715	0.2600	D61	0.2498	0.2200	D69	0.2879	0.2800
	0.2743	0.2650		0.2525	0.2250		0.2907	0.2850
	0.2798	0.2650		0.2580	0.2250		0.2962	0.2850
	0.2771	0.2600		0.2553	0.2200		0.2935	0.2800
D54	0.2688	0.2550	D62	0.2471	0.2150	D70	0.2852	0.2750
	0.2715	0.2600		0.2498	0.2200		0.2879	0.2800
	0.2771	0.2600		0.2553	0.2200		0.2935	0.2800
	0.2743	0.2550		0.2526	0.2150		0.2907	0.2750
D55	0.2661	0.2500	D63	0.2443	0.2100	D71	0.2825	0.2700
	0.2688	0.2550		0.2471	0.2150		0.2852	0.2750
	0.2743	0.2550		0.2526	0.2150		0.2907	0.2750
	0.2716	0.2500		0.2499	0.2100		0.2880	0.2700
D56	0.2634	0.2450	D64	0.2416	0.2050	D72	0.2798	0.2650
	0.2661	0.2500		0.2443	0.2100		0.2825	0.2700
	0.2716	0.2500		0.2499	0.2100		0.2880	0.2700
	0.2689	0.2450		0.2471	0.2050		0.2853	0.2650
D57	0.2607	0.2400	D65	0.2988	0.3000	D73	0.2771	0.2600
	0.2634	0.2450		0.3015	0.3050		0.2798	0.2650
	0.2689	0.2450		0.3071	0.3050		0.2853	0.2650
	0.2662	0.2400		0.3043	0.3000		0.2826	0.2600
D58	0.2579	0.2350	D66	0.2961	0.2950	D74	0.2743	0.2550
	0.2607	0.2400		0.2988	0.3000		0.2771	0.2600
	0.2662	0.2400		0.3043	0.3000		0.2826	0.2600
	0.2635	0.2350		0.3016	0.2950		0.2799	0.2550
D59	0.2552	0.2300	D67	0.2934	0.2900	D75	0.2716	0.2500
	0.2579	0.2350		0.2961	0.2950		0.2743	0.2550
	0.2635	0.2350		0.3016	0.2950		0.2799	0.2550
	0.2607	0.2300		0.2989	0.2900		0.2771	0.2500

Group	Cx	Cy	Group	Cx	Cy	Group	Cx	Cy
D76	0.2689	0.2450	D84	0.2471	0.2050	D92	0.2853	0.2650
	0.2716	0.2500		0.2499	0.2100		0.2880	0.2700
	0.2771	0.2500		0.2554	0.2100		0.2935	0.2700
	0.2744	0.2450		0.2527	0.2050		0.2908	0.2650
D77	0.2662	0.2400	D85	0.3043	0.3000	D93	0.2826	0.2600
	0.2689	0.2450		0.3071	0.3050		0.2853	0.2650
	0.2744	0.2450		0.3126	0.3050		0.2908	0.2650
	0.2717	0.2400		0.3099	0.3000		0.2881	0.2600
D78	0.2635	0.2350	D86	0.3016	0.2950	D94	0.2799	0.2550
	0.2662	0.2400		0.3043	0.3000		0.2826	0.2600
	0.2717	0.2400		0.3099	0.3000		0.2881	0.2600
	0.2690	0.2350		0.3071	0.2950		0.2854	0.2550
D79	0.2607	0.2300	D87	0.2989	0.2900	D95	0.2771	0.2500
	0.2635	0.2350		0.3016	0.2950		0.2799	0.2550
	0.2690	0.2350		0.3071	0.2950		0.2854	0.2550
	0.2663	0.2300		0.3044	0.2900		0.2827	0.2500
D80	0.2580	0.2250	D88	0.2962	0.2850	D96	0.2744	0.2450
	0.2607	0.2300		0.2989	0.2900		0.2771	0.2500
	0.2663	0.2300		0.3044	0.2900		0.2827	0.2500
	0.2635	0.2250		0.3017	0.2850		0.2799	0.2450
D81	0.2553	0.2200	D89	0.2935	0.2800	D97	0.2717	0.2400
	0.2580	0.2250		0.2962	0.2850		0.2744	0.2450
	0.2635	0.2250		0.3017	0.2850		0.2799	0.2450
	0.2608	0.2200		0.2990	0.2800		0.2772	0.2400
D82	0.2526	0.2150	D90	0.2907	0.2750	D98	0.2690	0.2350
	0.2553	0.2200		0.2935	0.2800		0.2717	0.2400
	0.2608	0.2200		0.2990	0.2800		0.2772	0.2400
	0.2581	0.2150		0.2963	0.2750		0.2745	0.2350
D83	0.2499	0.2100	D91	0.2880	0.2700	D99	0.2663	0.2300
	0.2526	0.2150		0.2907	0.2750		0.2690	0.2350
	0.2581	0.2150		0.2963	0.2750		0.2745	0.2350
	0.2554	0.2100		0.2935	0.2700		0.2718	0.2300

Group Name on Label

Example: DU-D100-H-24

Brightness	Color Chromaticity	Wavelength Groups	Forward Voltage
DU	D100	H	24

Relative Spectral Emission ^{6), 7)}

$\Phi_{rel} = f(\lambda); I_F = 15 \text{ mA}; T_S = 25 \text{ }^\circ\text{C}$

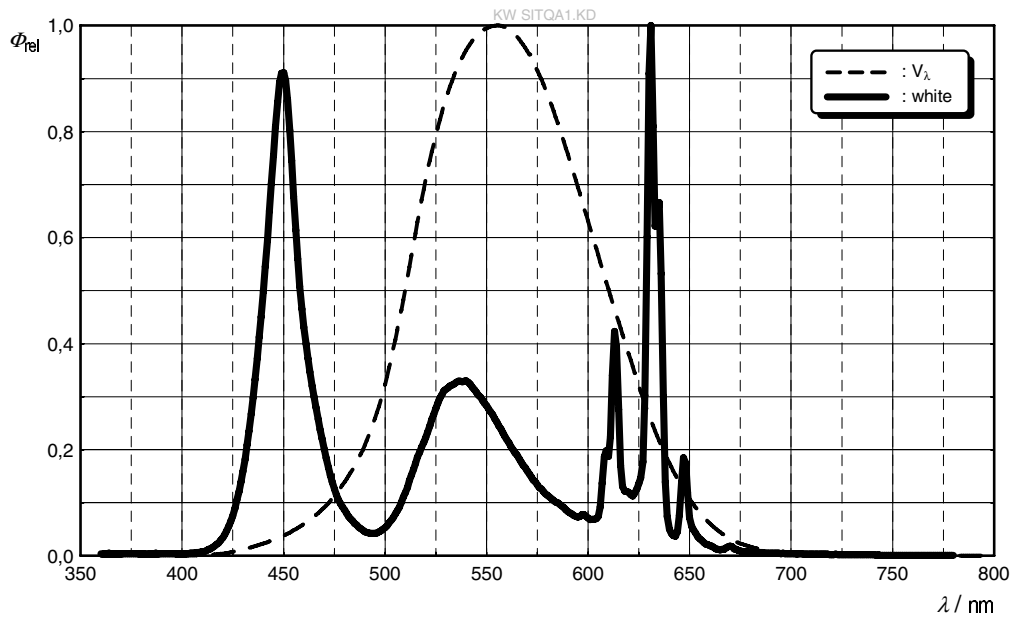

Radiation Characteristics ⁶⁾

$I_{rel} = f(\phi); T_S = 25 \text{ }^\circ\text{C}$

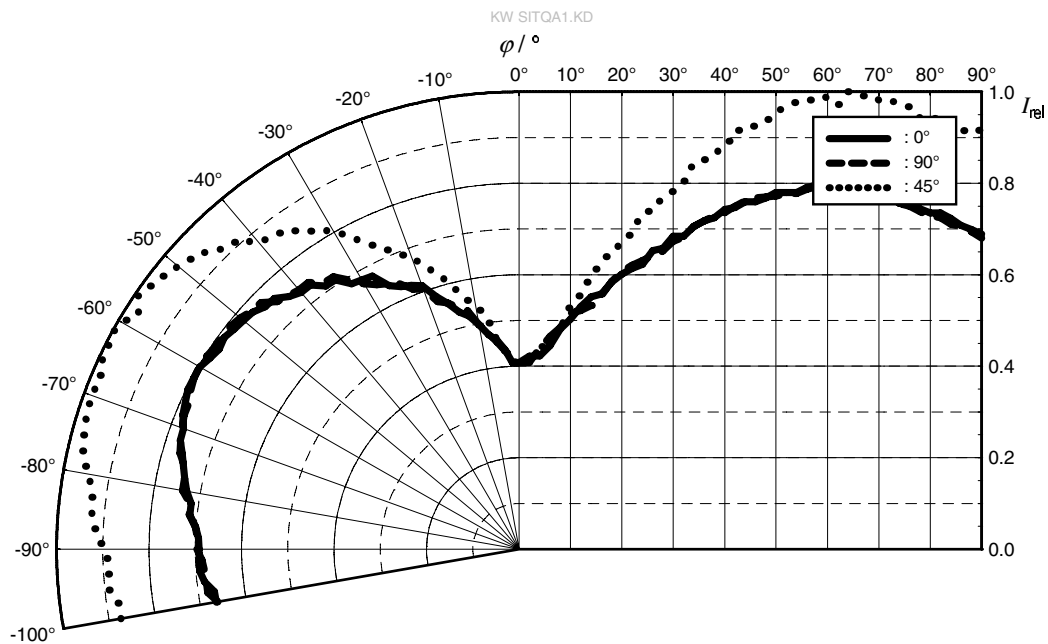

Forward current ⁶⁾

$$I_F = f(V_F); T_S = 25\text{ °C}$$

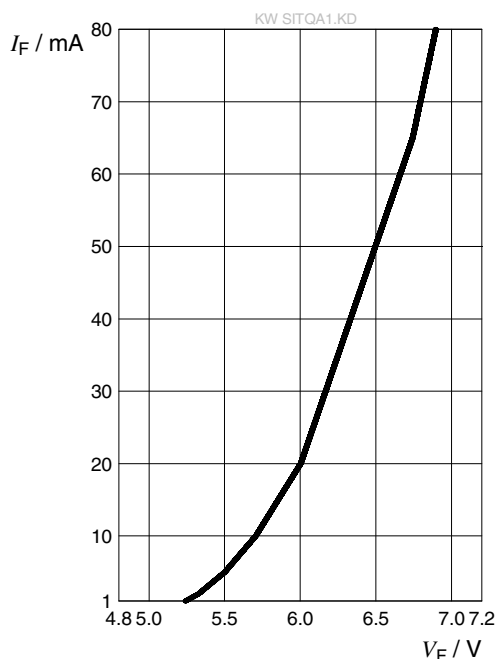

Relative Luminous Flux ^{6), 8)}

$$\Phi_V / \Phi_V(15\text{ mA}) = f(I_F); T_S = 25\text{ °C}$$

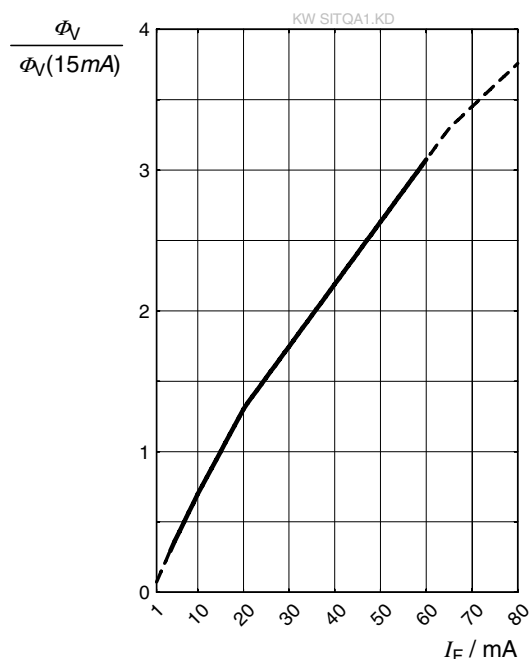

Chromaticity Coordinate Shift ⁶⁾

$$\Delta C_x, \Delta C_y = f(I_F); T_S = 25\text{ °C}$$

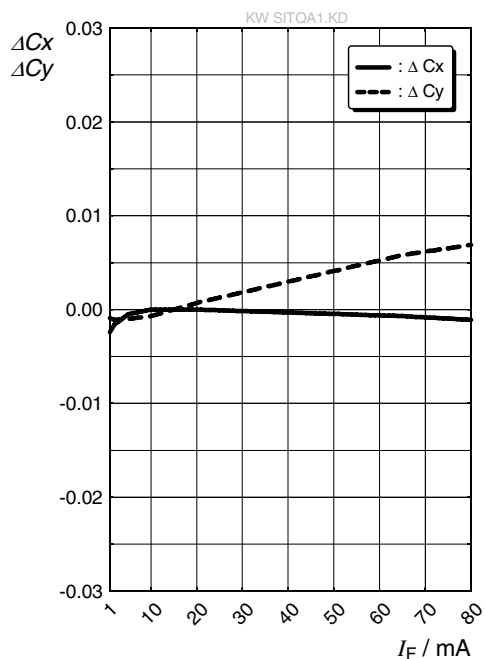

Forward Voltage ⁶⁾

$$\Delta V_F = V_F - V_F(25\text{ }^\circ\text{C}) = f(T_j); I_F = 15\text{ mA}$$

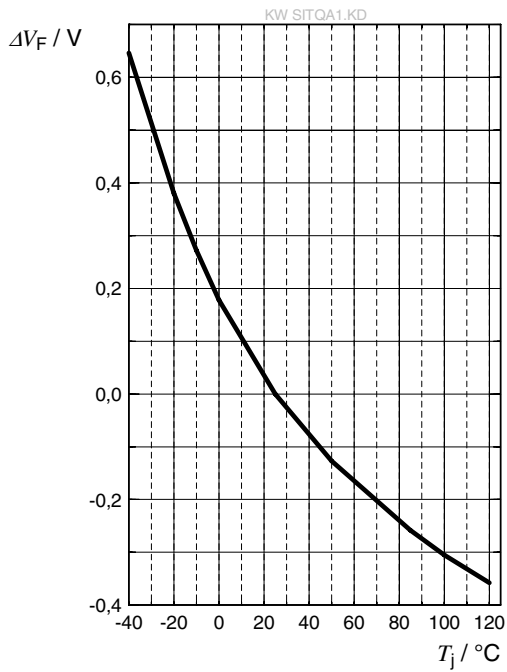

Relative Luminous Flux ⁶⁾

$$\Phi_V / \Phi_V(25\text{ }^\circ\text{C}) = f(T_j); I_F = 15\text{ mA}$$

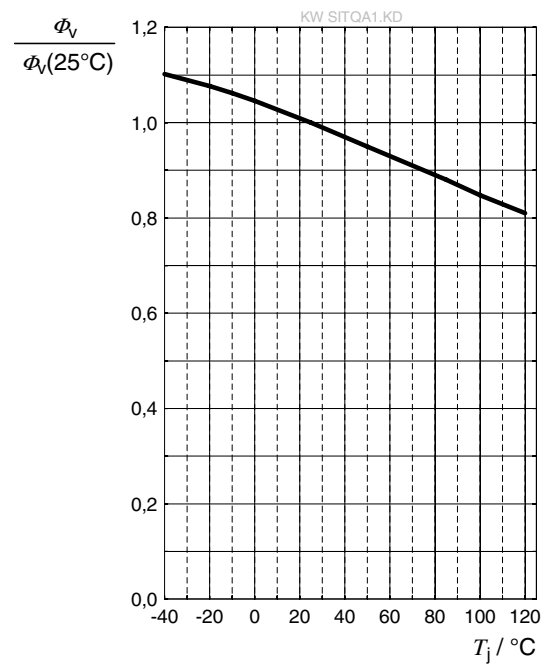

Chromaticity Coordinate Shift ⁶⁾

$$\Delta C_x, \Delta C_y = f(T_j); I_F = 15\text{ mA}$$

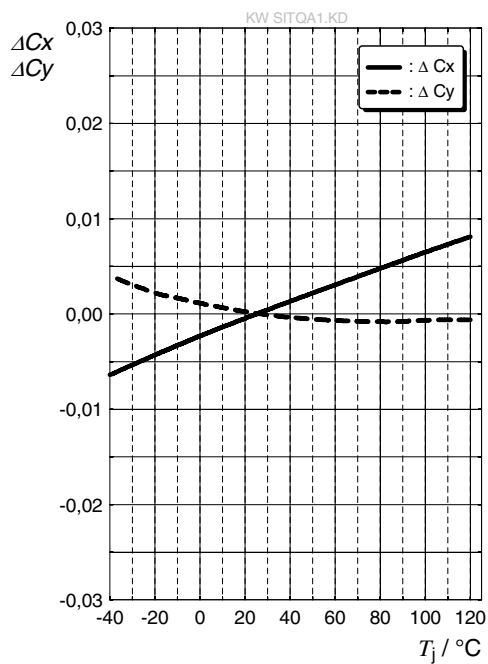

Max. Permissible Forward Current

$I_F = f(T)$

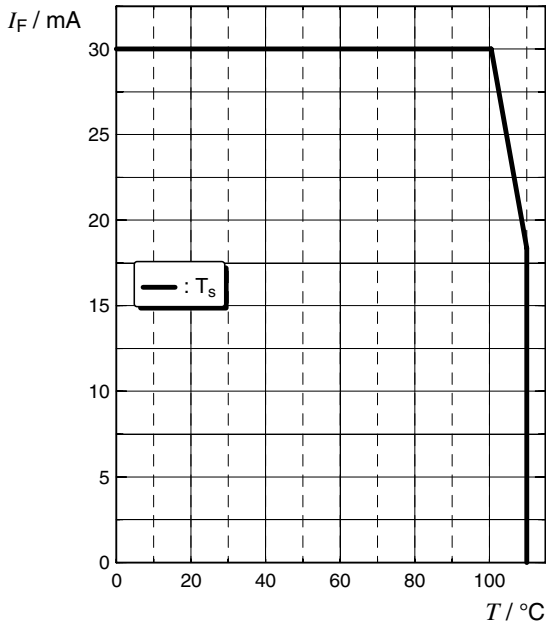

Permissible Pulse Handling Capability ⁷⁾

$I_F = f(t_p)$; D: Duty cycle

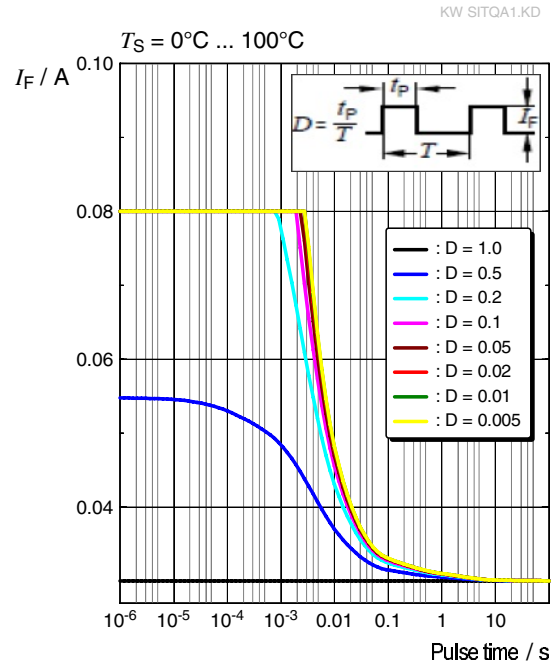

Permissible Pulse Handling Capability ⁷⁾

$I_F = f(t_p)$; D: Duty cycle

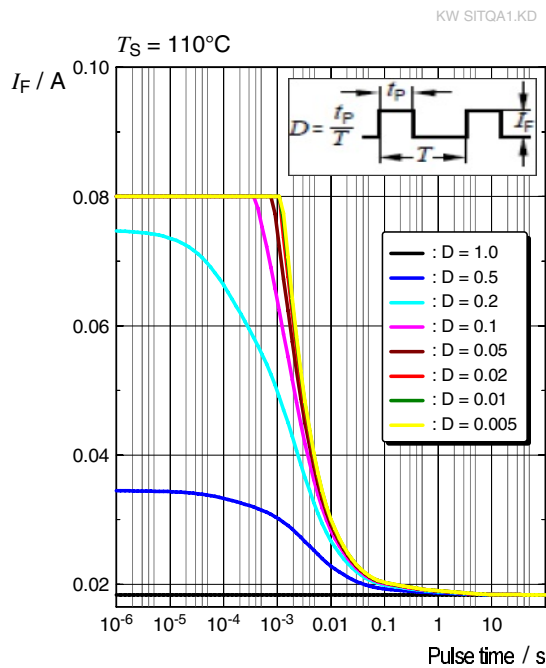

Dimensional Drawing ⁹⁾

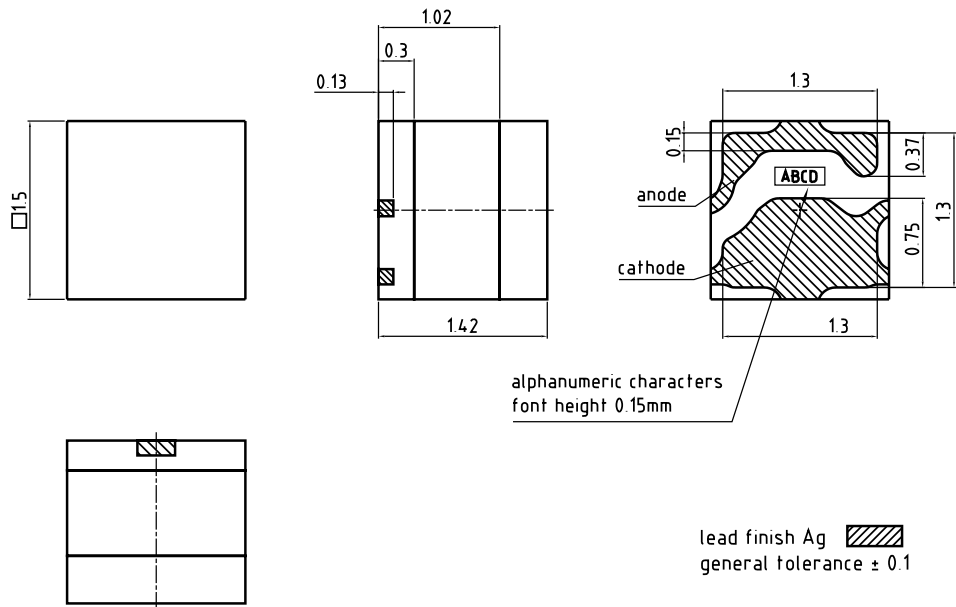

C63062-A4411-A1-04

Further Information:

Approximate Weight: 6.2 mg

Corrosion test: Class: 2B
Test condition: 25°C / 75 % RH / 10 ppm H₂S / 21 days (IEC 60068-2-43)

Electrical Internal Circuit

Polarity



Recommended Solder Pad ⁹⁾

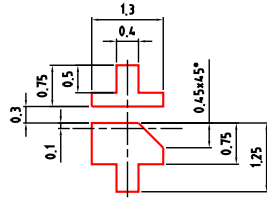

only use NonSolderMaskDefined Solder Pads

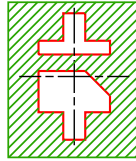

solder resist

The usage of solder resist between anode and cathode pads is mandatory for applications where water may condense

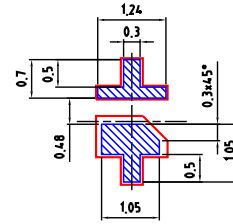

solder stencil
recommended stencil
thickness 80µm

Component Location on Pad

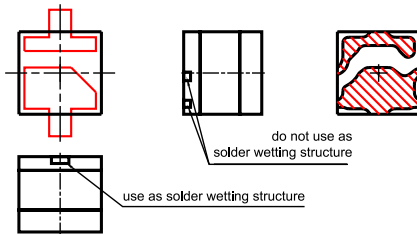

For further details on assembly and soldering please consult application note: SYNIOS E1515 and SYNIOS P1515-Details on handling and assembly

E062 3010.279 -04

All products are packed in a dry pack bag (Moisture Barrier Bag, MBB) according MIL-PRF-81705, after opening the MBB the products should go to reflow soldering process. Unused remaining LEDs should be protected from environment due to silver plated soldering terminal. In order to maintain solderability it is recommended to protect the silver plated solder terminals from corrosive environment before soldering. For superior solder joint connectivity results we recommend soldering under standard nitrogen atmosphere.

Reflow Soldering Profile

Product complies to MSL Level 3 acc. to JEDEC J-STD-020E

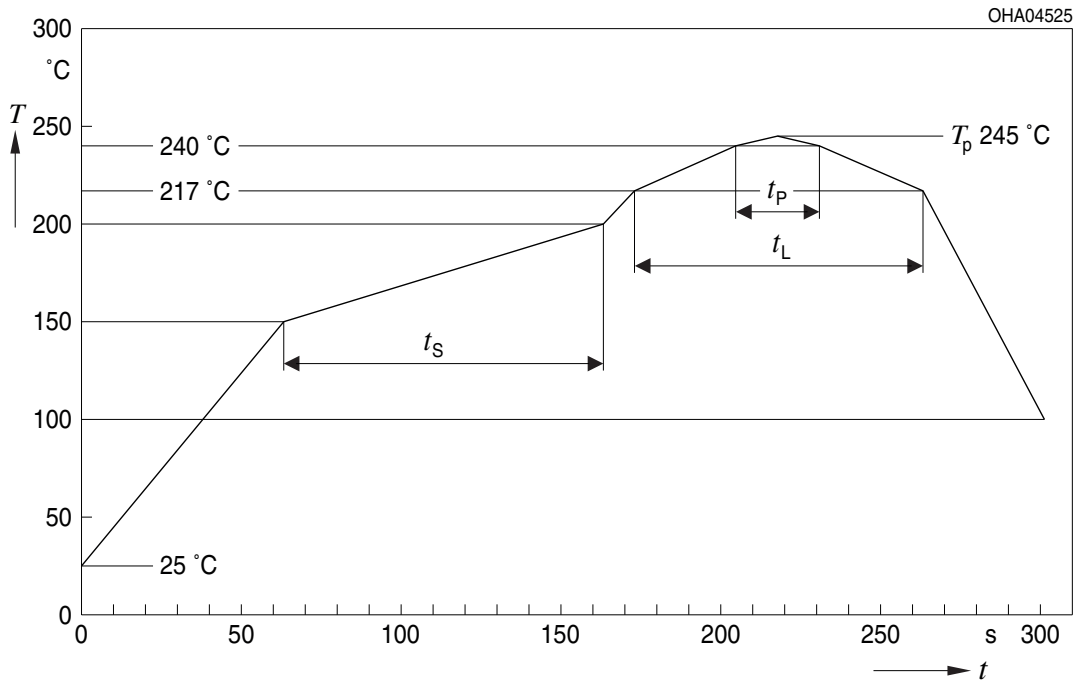

Profile Feature	Symbol	Pb-Free (SnAgCu) Assembly			Unit
		Minimum	Recommendation	Maximum	
Ramp-up rate to preheat ⁾ 25 °C to 150 °C			2	3	K/s
Time t_s T_{Smin} to T_{Smax}	t_s	60	100	120	s
Ramp-up rate to peak ⁾ T_{Smax} to T_p			2	3	K/s
Liquidus temperature	T_L		217		°C
Time above liquidus temperature	t_L		80	100	s
Peak temperature	T_p		245	260	°C
Time within 5 °C of the specified peak temperature $T_p - 5$ K	t_p	10	20	30	s
Ramp-down rate* T_p to 100 °C			3	6	K/s
Time 25 °C to T_p				480	s

All temperatures refer to the center of the package, measured on the top of the component

* slope calculation DT/Dt : Dt max. 5 s; fulfillment for the whole T-range

Taping ⁹⁾

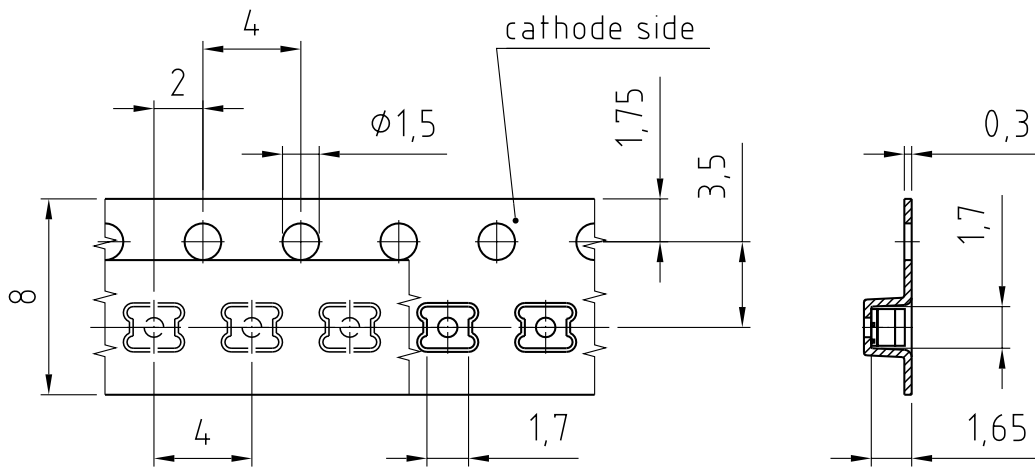

C63062-A4411-B8-03

Tape and Reel ¹⁰⁾

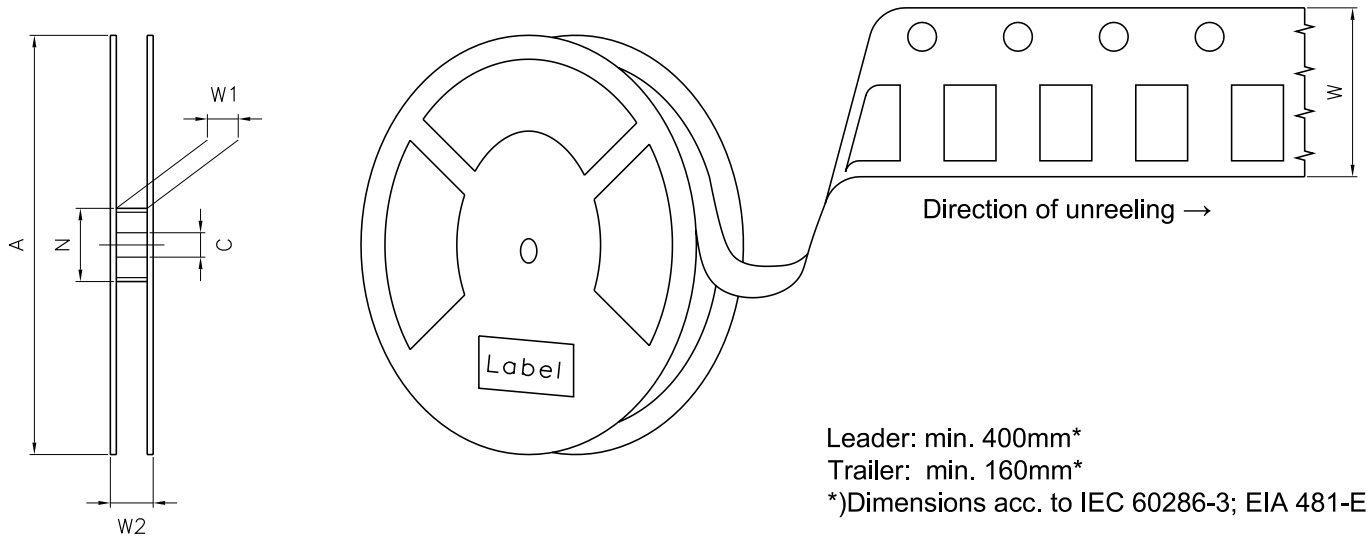

Reel Dimensions

A	W	N _{min}	W ₁	W _{2 max}	Pieces per PU
180 mm	8 + 0.3 / - 0.1 mm	60 mm	8.4 + 2 mm	14.4 mm	2500

Barcode-Product-Label (BPL)

OSRAM Opto Semiconductors LX XXXX BIN1: XX-XX-X-XXX-X

RoHS Compliant

(6P) BATCH NO: 1234567890

(1T) LOT NO: 1234567890 (9D) D/C: 1234

(X) PROD NO: 123456789(Q)QTY: 9999 (G) GROUP: XX-XX-X-X

ML Temp ST
X XXX °C X

Pack: RXX
DEMY XXX
X_X123_1234.1234 X

OHA04563

Dry Packing Process and Materials ⁹⁾

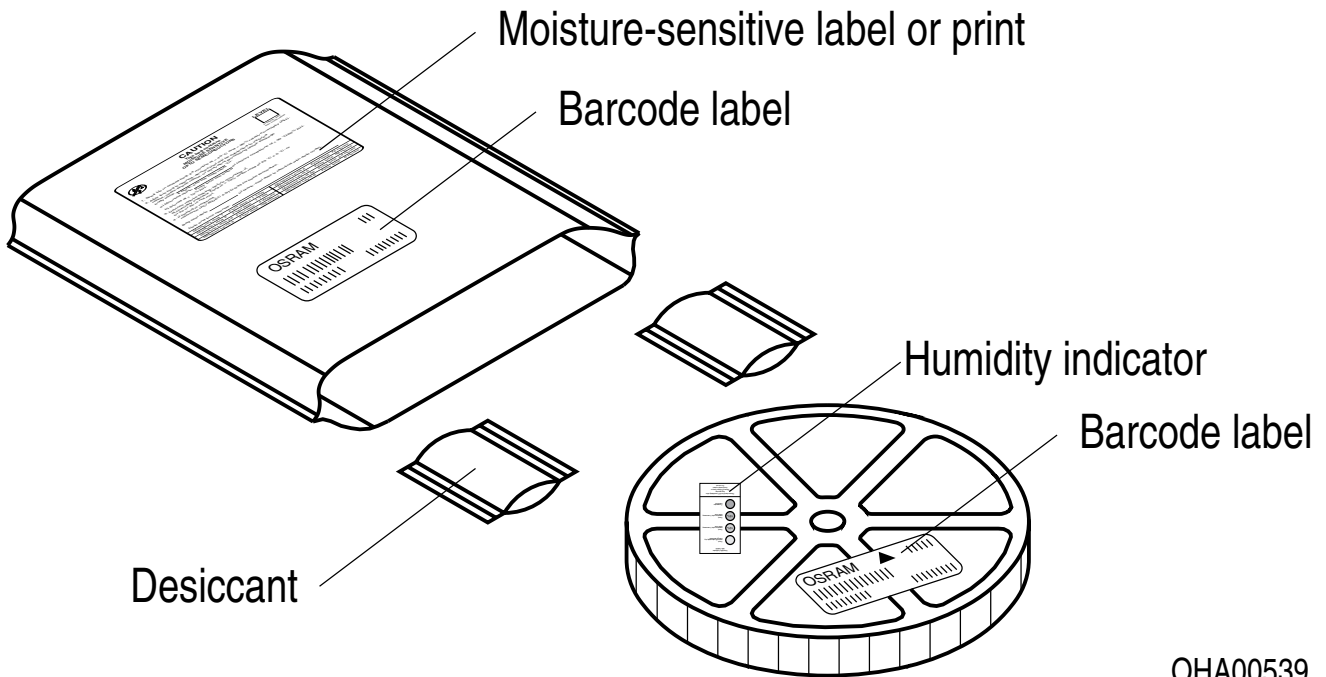

OHA00539

Moisture-sensitive product is packed in a dry bag containing desiccant and a humidity card according JEDEC-STD-033.

Type Designation System

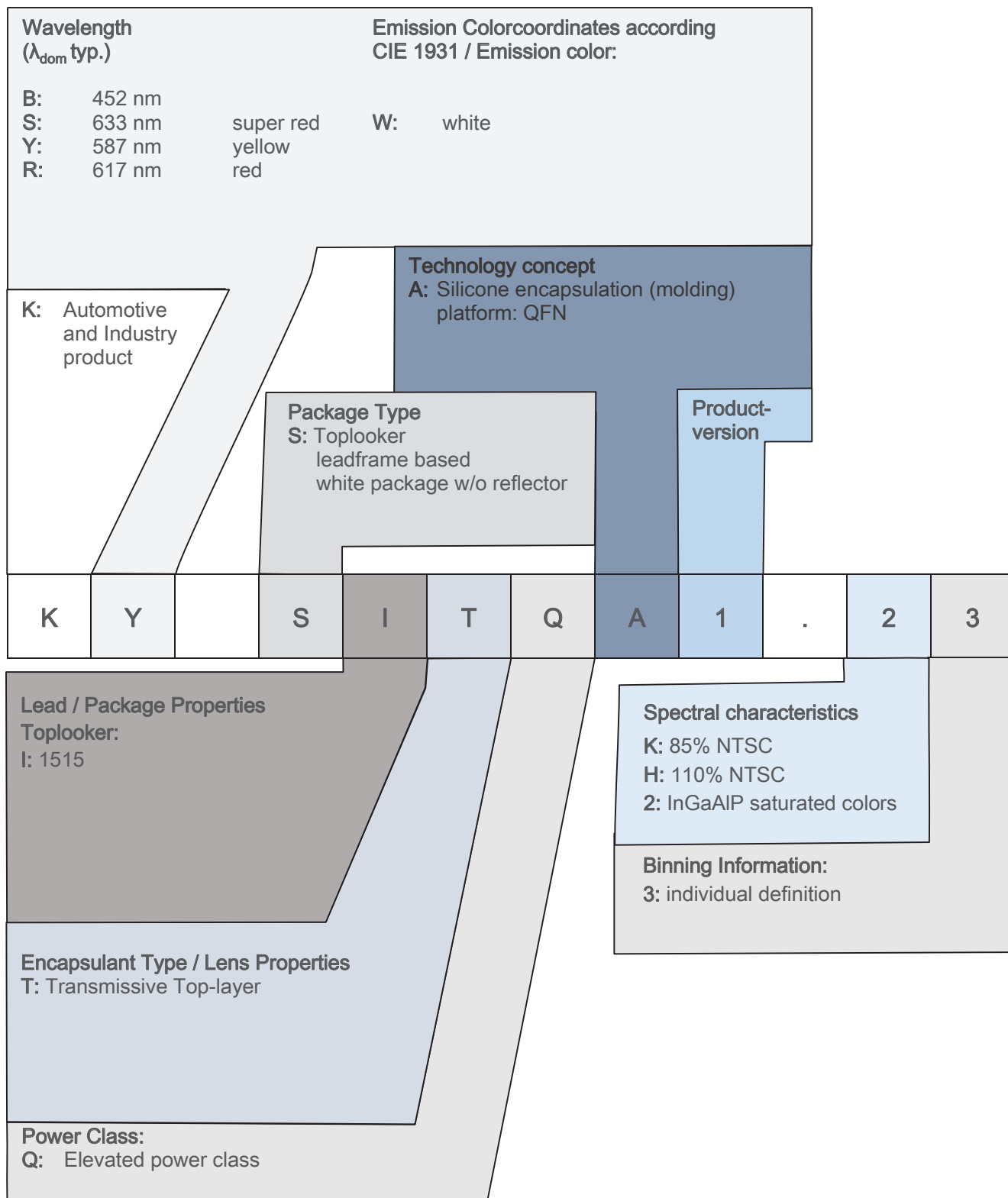

Notes

The evaluation of eye safety occurs according to the standard IEC 62471:2006 (photo biological safety of lamps and lamp systems). Within the risk grouping system of this IEC standard, the device specified in this data sheet fall into the class **exempt group (exposure time 10000 s)**. Under real circumstances (for exposure time, conditions of the eye pupils, observation distance), it is assumed that no endangerment to the eye exists from these devices. As a matter of principle, however, it should be mentioned that intense light sources have a high secondary exposure potential due to their blinding effect. When looking at bright light sources (e.g. headlights), temporary reduction in visual acuity and afterimages can occur, leading to irritation, annoyance, visual impairment, and even accidents, depending on the situation.

Subcomponents of this device contain, in addition to other substances, metal filled materials including silver. Metal filled materials can be affected by environments that contain traces of aggressive substances. Therefore, we recommend that customers minimize device exposure to aggressive substances during storage, production, and use. Devices that showed visible discoloration when tested using the described tests above did show no performance deviations within failure limits during the stated test duration. Respective failure limits are described in the IEC60810.

For further application related information please visit www.osram-os.com/appnotes

Disclaimer

Attention please!

The information describes the type of component and shall not be considered as assured characteristics. Terms of delivery and rights to change design reserved. Due to technical requirements components may contain dangerous substances.

For information on the types in question please contact our Sales Organization.

If printed or downloaded, please find the latest version on our website.

Packing

Please use the recycling operators known to you. We can also help you – get in touch with your nearest sales office. By agreement we will take packing material back, if it is sorted. You must bear the costs of transport. For packing material that is returned to us unsorted or which we are not obliged to accept, we shall have to invoice you for any costs incurred.

Product and functional safety devices/applications or medical devices/applications

Our components are not developed, constructed or tested for the application as safety relevant component or for the application in medical devices.

Our products are not qualified at module and system level for such application.

In case buyer – or customer supplied by buyer – considers using our components in product safety devices/ applications or medical devices/applications, buyer and/or customer has to inform our local sales partner immediately and we and buyer and /or customer will analyze and coordinate the customer-specific request between us and buyer and/or customer.

Glossary

- 1) **Brightness:** Brightness values are measured during a current pulse of typically 60 ms, with an internal reproducibility of $\pm 8\%$ and an expanded uncertainty of $\pm 11\%$ (acc. to GUM with a coverage factor of $k = 3$).
- 2) **Reverse Operation:** This product is intended to be operated applying a forward current within the specified range. Applying any continuous reverse bias or forward bias below the voltage range of light emission shall be avoided because it may cause migration which can change the electro-optical characteristics or damage the LED.
- 3) **Chromaticity coordinate groups:** Chromaticity coordinates are measured during a current pulse of typically 60 ms, with an internal reproducibility of ± 0.005 and an expanded uncertainty of ± 0.01 (acc. to GUM with a coverage factor of $k = 3$).
- 4) **Forward Voltage:** The forward voltage is measured during a current pulse of typically 43 ms, with an internal reproducibility of $\pm 0.05\text{ V}$ and an expanded uncertainty of $\pm 0.1\text{ V}$ (acc. to GUM with a coverage factor of $k = 3$).
- 5) **Thermal Resistance:** $R_{th\ max}$ is based on statistic values (6σ).
- 6) **Typical Values:** Due to the special conditions of the manufacturing processes of semiconductor devices, the typical data or calculated correlations of technical parameters can only reflect statistical figures. These do not necessarily correspond to the actual parameters of each single product, which could differ from the typical data and calculated correlations or the typical characteristic line. If requested, e.g. because of technical improvements, these typ. data will be changed without any further notice.
- 7) **Luminescence:** The red conversion material used in this LED has a significantly slower response time compared to the green conversion material and the blue emitter.
The red converter will fluoresce with a rise and decay time of about 8ms. This may result in a visible red sparkling effect if operated in pulse-width-modulation mode. In order to mitigate such effect please consider DC mode operation or apply appropriate timing in combination with circuit design.
- 8) **Characteristic curve:** In the range where the line of the graph is broken, you must expect higher differences between single devices within one packing unit.
- 9) **Tolerance of Measure:** Unless otherwise noted in drawing, tolerances are specified with ± 0.1 and dimensions are specified in mm.
- 10) **Tape and Reel:** All dimensions and tolerances are specified acc. IEC 60286-3 and specified in mm.

Revision History

Version	Date	Change
1.0	2021-09-23	Initial Version
1.1	2021-10-05	Electro - Optical Characteristics (Diagrams)
1.2	2022-11-22	Maximum Ratings Recommended Solder Pad New Layout Applications



EU RoHS and China RoHS compliant product

此产品符合欧盟 RoHS 指令的要求；
按照中国的相关法规和标准，
不含有毒有害物质或元素。

Published by ams-OSRAM AG

Tobelbader Strasse 30, 8141 Premstaetten, Austria

Phone +43 3136 500-0

ams-osram.com

© All rights reserved

am 

OSRAM