



2.5GHz, 22dBm/20dBm Power Amplifiers with Analog Closed-Loop Power Control

General Description

The MAX2244/MAX2245/MAX2246 single-supply, low-voltage power amplifiers (PAs) are designed for 20dBm Bluetooth™ Class 1 applications in the 2.4GHz to 2.5GHz band. The MAX2244/MAX2245 deliver a peak output power of 22dBm with greater than 20dB output-power control range. The 22dBm output power compensates for the filter loss between the PA and the antenna, allowing 20dBm to be delivered to the antenna. The MAX2246 provides a peak output power of 20dBm for a 30% reduction in supply current.

The PAs integrate a power detector and closed-loop power-control circuitry to provide nearly constant output power over the full range of supply voltage, temperature, and input power level. The voltage at the analog control input precisely controls the output power level.

The MAX2244/MAX2245/MAX2246 feature a low-current shutdown mode through a simple logic input. Internal circuitry automatically controls the ramp-up/down of the output power level during turn-on and turn-off to meet Bluetooth spurious emissions requirements.

The devices operate from a 3V to 3.6V single supply. The MAX2244/MAX2246 have a power-control voltage range of 0.5V to 2V, and the MAX2245 has a control voltage range of 0.9V to 2.2V. The devices are packaged in a miniature ultra chip-scale package (UCSP™), significantly reducing the required board area.

Applications

- Bluetooth Class 1 Radios
- 802.11 FHSS/HomeRF™ Radios
- 2.4GHz Cordless Phones

Features

- ◆ 2.4GHz to 2.5GHz Operation
- ◆ Accurate Closed-Loop Output Power Control Over Full Temperature, Supply, and Input Power Range
- ◆ Convenient Analog Power-Control Interface
- ◆ 22dBm Peak Output Power (MAX2244/MAX2245)
- ◆ 20dBm Peak Output with 30% Reduced Supply Current (MAX2246)
- ◆ Internal Bandwidth-Limited Power Ramping
- ◆ 50Ω Integrated Input Match
- ◆ 0.5μA Shutdown Supply Current
- ◆ Ultra Chip-Scale Package (1.56mm × 1.56mm)

Ordering Information

PART	TEMP RANGE	BUMP PACKAGE	TOP MARK
MAX2244EBL-T	-40°C to +85°C	9 UCSP*-9	AAP
MAX2245EBL-T	-40°C to +85°C	9 UCSP*-9	AAQ
MAX2246EBL-T	-40°C to +85°C	9 UCSP*-9	AAZ

*UCSP reliability is integrally linked to the user's assembly methods, circuit board material, and environment. See the UCSP Reliability Notice in the UCSP Reliability section of this data sheet for more information.

Pin Configuration appears at end of data sheet.

Functional Diagram

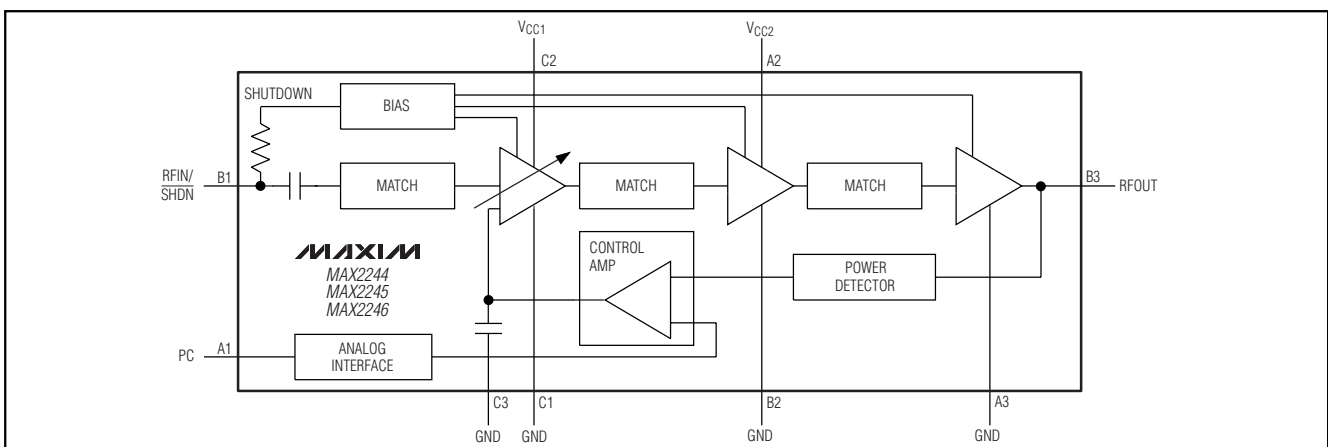

Bluetooth is a trademark of Ericsson Corp.

HomeRF is a trademark of The HomeRF Working Group.

UCSP is a trademark of Maxim Integrated Products, Inc.



For pricing, delivery, and ordering information, please contact Maxim/Dallas Direct! at 1-888-629-4642, or visit Maxim's website at www.maxim-ic.com.

MAX2244/MAX2245/MAX2246

2.5GHz, 22dBm/20dBm Power Amplifiers with Analog Closed-Loop Power Control

ABSOLUTE MAXIMUM RATINGS

V_{CC1}, V_{CC2}, RFOUT to GND-0.3V to +6.0V
 RFIN/SHDN, PC to GND.....-0.3V to (V_{CC} + 0.3V)
 RF Input Power (RFIN).....+10dBm
 Load Mismatch (VSWR) Without Damage6:1
 Continuous Power Dissipation (T_A = +85°C)
 9-Pin UCSF (derate 8.8mW/°C above T_A = +85°C).....700mW

Operating Temperature Range-40°C to +85°C
 Junction Temperature+150°C
 Storage Temperature Range-65°C to +150°C
 Continuous Operating Lifetime.....10 years x 0.935^(T_A - 65°C)
 (for operating temperature 65°C < T_A < 85°C)

Stresses beyond those listed under "Absolute Maximum Ratings" may cause permanent damage to the device. These are stress ratings only, and functional operation of the device at these or any other conditions beyond those indicated in the operational sections of the specifications is not implied. Exposure to absolute maximum rating conditions for extended periods may affect device reliability.

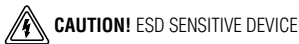

DC ELECTRICAL CHARACTERISTICS

(Typical Application Circuit, V_{CC} = 3V to 3.6V, no RF signals applied, V_{SHDN} ≥ 2V, V_{PC} = 0, T_A = -40°C to +85°C, unless otherwise noted. Typical values are at V_{CC} = 3V, T_A = +25°C, unless otherwise noted.) (Note 1)

PARAMETER	CONDITIONS		MIN	TYP	MAX	UNITS
Supply Voltage			3.0		3.6	V
Supply Current (Note 2)	MAX2244 P _{RFIN} = 0 to 4dBm, 2.45GHz	V _{PC} = 0.5V, T _A = +25°C		65	83	mA
		V _{PC} = 0.5V, T _A = -40°C to +85°C			98	
		V _{PC} = 2V, T _A = +25°C		172	200	
		V _{PC} = 2V, T _A = -40°C to +85°C			205	
	MAX2245 P _{RFIN} = 0 to 4dBm, 2.45GHz	V _{PC} = 0.9V, T _A = +25°C		65	87	
		V _{PC} = 0.9V, T _A = -40°C to +85°C			93	
		V _{PC} = 2.2V, T _A = +25°C		179	195	
		V _{PC} = 2.2V, T _A = -40°C to +85°C			208	
	MAX2246 P _{RFIN} = 0 to 4dBm, 2.45GHz	V _{PC} = 0.5V, T _A = +25°C		42	55	
		V _{PC} = 0.5V, T _A = -40°C to +85°C			61	
		V _{PC} = 2V, T _A = +25°C		118	140	
		V _{PC} = 2V, T _A = -40°C to +85°C			144	
Shutdown Supply Current	SHDN = GND			0.5	10	μA
SHDN Input Voltage High			2.0			V
SHDN Input Voltage Low					0.6	V
SHDN Input Current			-1		1	μA
PC Input Voltage Range	Active control range	MAX2244/MAX2246	0.5		2.0	V
		MAX2245	0.9		2.5	
PC Input Current	MAX2244/MAX2246, V _{PC} = 0 to 2.5V		-15		5	μA
	MAX2245, V _{PC} = 0 to 3V		-20		10	

2.5GHz, 22dBm/20dBm Power Amplifiers with Analog Closed-Loop Power Control

MAX2244/MAX2245/MAX2246

AC ELECTRICAL CHARACTERISTICS

(Typical Application Circuit, $V_{CC} = 3V$, $P_{RFIN} = 0$ to 4dBm, $f_{RFIN} = 2.45GHz$, 50Ω system, $V_{SHDN} \geq 2V$, $T_A = +25^\circ C$, unless otherwise noted. Typical values are at $V_{CC} = 3V$, $P_{RFIN} = 2dBm$, $f_{RFIN} = 2.45GHz$, $T_A = +25^\circ C$, unless otherwise noted.)

PARAMETER	CONDITIONS		MIN	TYP	MAX	UNITS
Frequency Range (Note 3)			2.4		2.5	GHz
Input Power			0		4	dBm
Output Power (Note 2)	MAX2244, $V_{PC} = 0.5V$	$T_A = +25^\circ C$	0	4	7	dBm
	MAX2244, $V_{PC} = 2V$	$T_A = +25^\circ C$	20.5	22.0	23.5	
		$T_A = -40^\circ C$ to $+85^\circ C$	20		24	
	MAX2245, $V_{PC} = 0.9V$	$T_A = +25^\circ C$	0	4	7	
	MAX2245, $V_{PC} = 2.2V$	$T_A = +25^\circ C$	20.5	22.0	23.5	
		$T_A = -40^\circ C$ to $+85^\circ C$	20		24	
	MAX2246, $V_{PC} = 0.5V$	$T_A = +25^\circ C$	-4.5	0.5	5.5	
MAX2246, $V_{PC} = 2V$		$T_A = +25^\circ C$	19	20	21	
		$T_A = -40^\circ C$ to $+85^\circ C$	17		21	
Harmonic Output (Notes 2, 4)	PRFOUT at any level	MAX2244/MAX2245		-7	-1	dBm
		MAX2246		-16	-13	
Shutdown Mode Output (Note 2)	$V_{SHDN} \leq 0.6V$, $P_{RFIN} = 4dBm$				-30	dBm
In-Band Spurious (Notes 2, 3, 5)	Frequency offset = $\pm 500kHz$			-20		dBc
	Frequency offset = $\pm 1.5MHz$			-20		dBm
	Frequency offset = $\pm 2.5MHz$			-40		
Nonharmonic Spurious Output (Note 2)	All power levels, load VSWR $\leq 3:1$				-30	dBm
Power Ramp Turn-On Time (Notes 2, 6)	MAX2244/MAX2246, V_{PC} steps from 0 to 2V			4		μs
	MAX2245/MAX2246, V_{PC} steps from 0 to 2.5V			4		
Power Ramp Turn-Off Time (Notes 2, 7)	MAX2244, V_{PC} steps from 2V to 0			1.8		μs
	MAX2245, V_{PC} steps from 2.5V to 0			1.8		
Input VSWR (Note 2)	$R_S = 50\Omega$, over full P_{RFIN} range			1.5:1	2:1	

Note 1: Limits are 100% production tested at $T_A = +25^\circ C$. Limits over the entire operating temperature range are guaranteed by design and characterization, but are not production tested.

Note 2: Guaranteed by design and characterization.

Note 3: Assumes the output is optimally matched to cover the 2.4GHz to 2.5GHz band.

Note 4: Valid for the case in which the output stage is matched with a two-section transmission line, lowpass matching network to minimize the 2nd and 3rd harmonics, as shown in the *Typical Application Circuit*.

Note 5: Output measured in a 100kHz RBW. Power on/off duty cycle = 50%. Test signal: GFSK, BT = 0.5, 1 bit/symbol, 1Mbps, frequency deviation = 175kHz.

Note 6: The total turn-on and settling time required for the PA output power to settle to within $\pm 1dB$ of the final value.

Note 7: The total turn-off time for the PA output power to drop to -10dBm.

2.5GHz, 22dBm/20dBm Power Amplifiers with Analog Closed-Loop Power Control

Typical Operating Characteristics

(Typical Application Circuit, $V_{CC} = 3V$, $P_{RFIN} = 2dBm$, $f_{RFIN} = 2.45GHz$, $\overline{SHDN} = V_{CC}$, $T_A = +25^\circ C$, unless otherwise noted.)

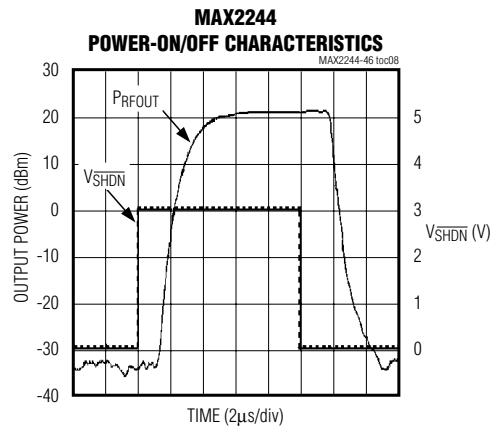
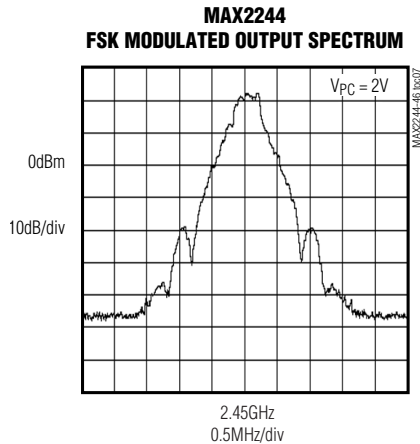
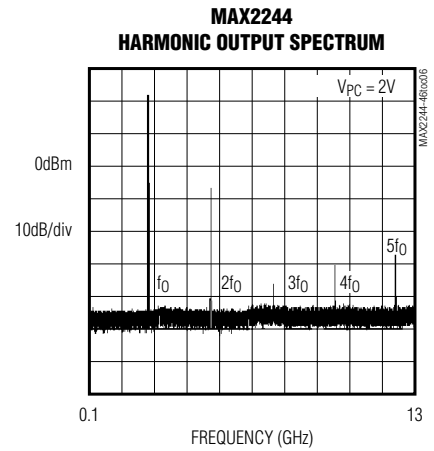
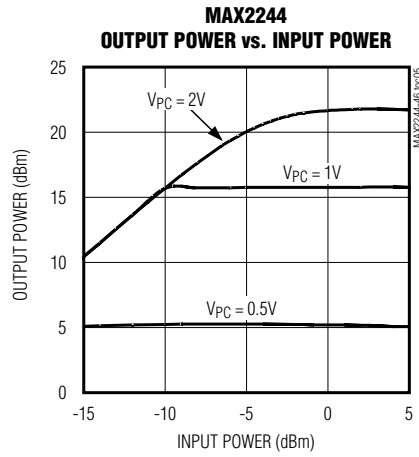
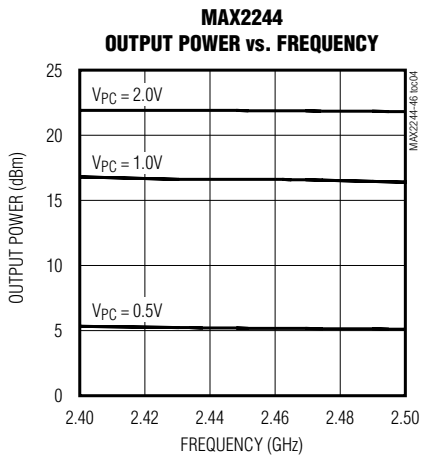
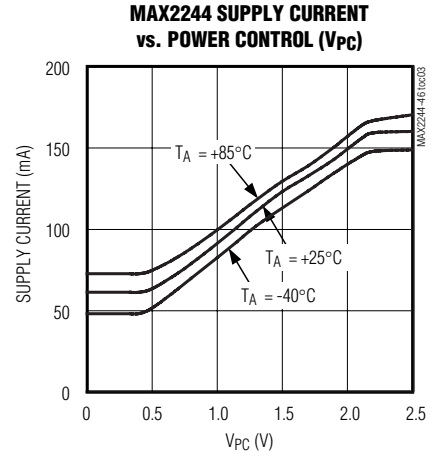
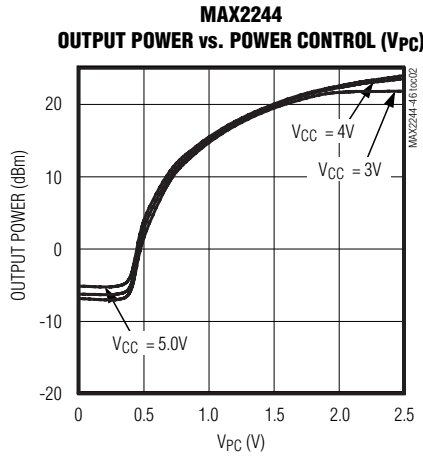
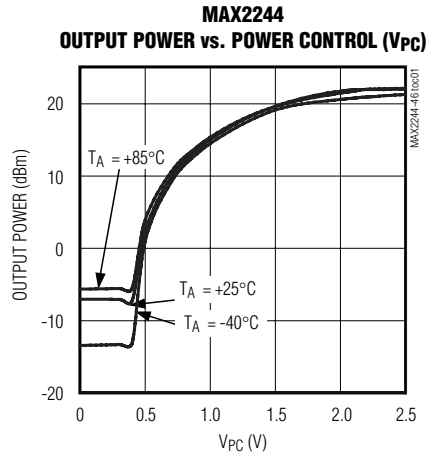

2.5GHz, 22dBm/20dBm Power Amplifiers with Analog Closed-Loop Power Control

Typical Operating Characteristics (continued)

(Typical Application Circuit, $V_{CC} = 3V$, $P_{RFIN} = 2dBm$, $f_{RFIN} = 2.45GHz$, $\overline{SHDN} = V_{CC}$, $T_A = +25^\circ C$, unless otherwise noted.)

MAX2244/MAX2245/MAX2246

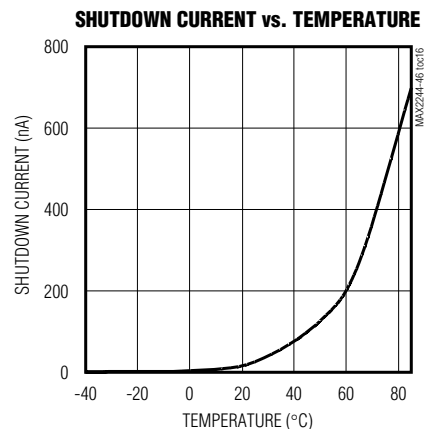
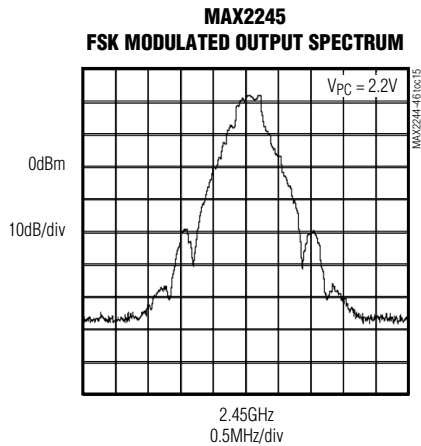
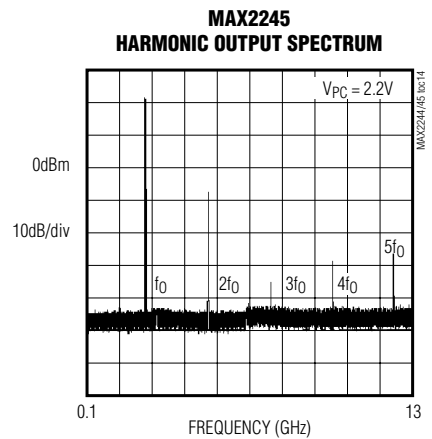
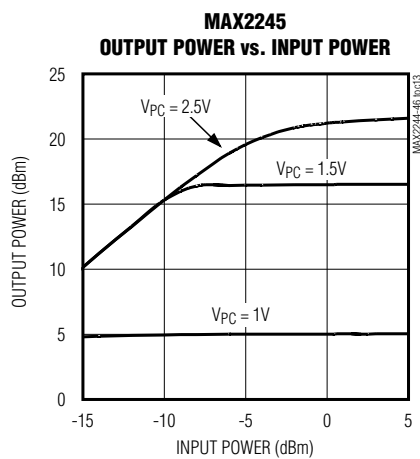
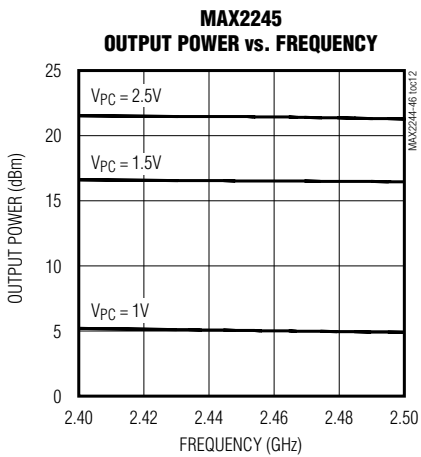
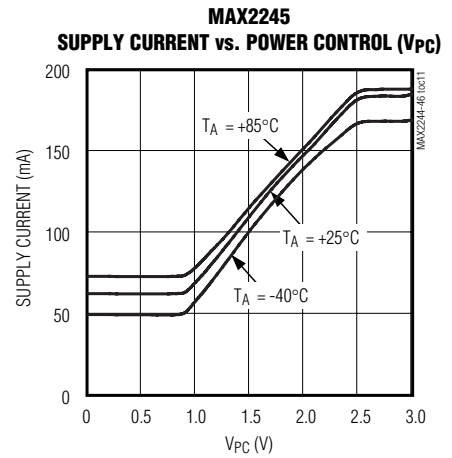
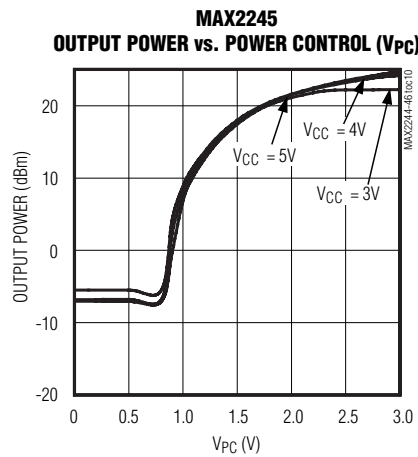
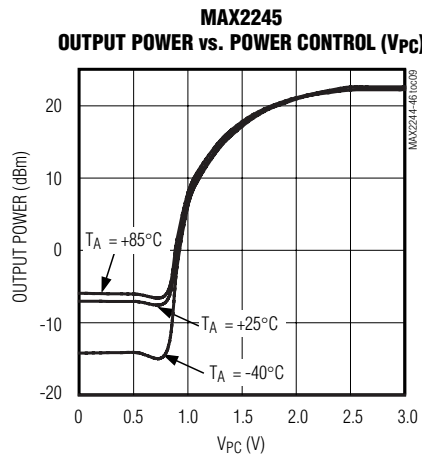

2.5GHz, 22dBm/20dBm Power Amplifiers with Analog Closed-Loop Power Control

Typical Operating Characteristics (continued)

(Typical Application Circuit, $V_{CC} = 3V$, $PR_{FIN} = 2dBm$, $f_{RFIN} = 2.45GHz$, $\overline{SHDN} = V_{CC}$, $T_A = +25^\circ C$, unless otherwise noted.)

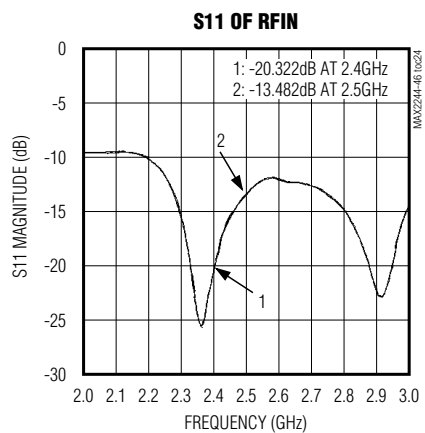
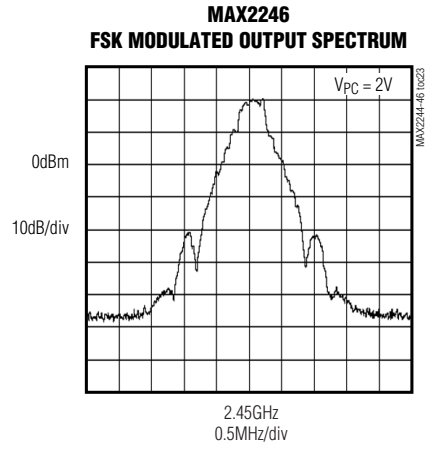
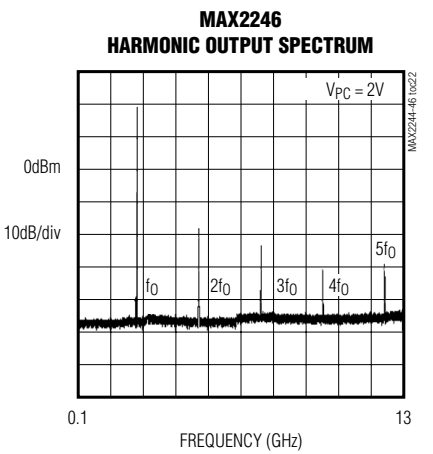
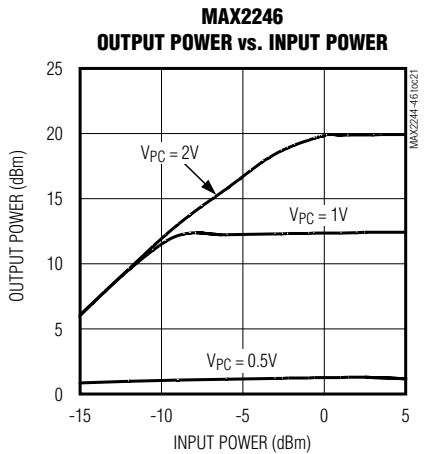
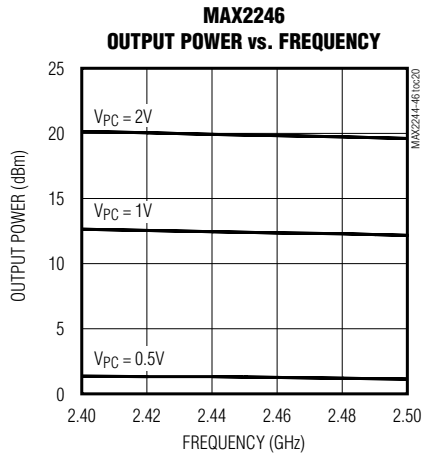
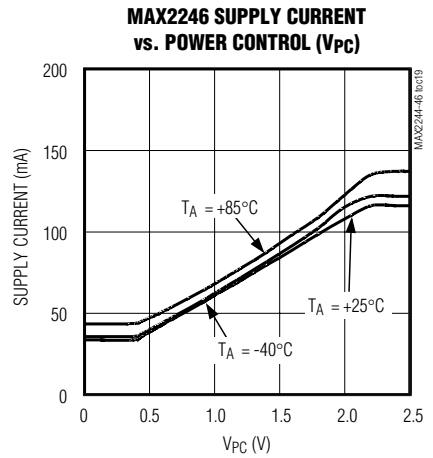
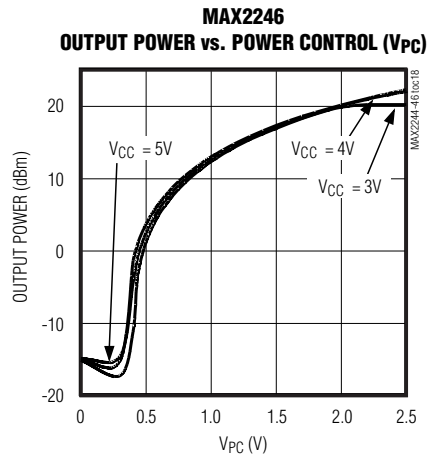
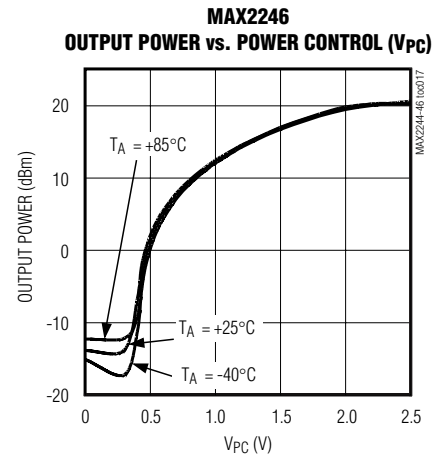

2.5GHz, 22dBm/20dBm Power Amplifiers with Analog Closed-Loop Power Control

MAX2244/MAX2245/MAX2246

Pin Description

PIN	NAME	DESCRIPTION
A1	PC	Power-Control Voltage Input. Adjust PC between 0.5V and 2V (MAX2244/MAX2246) or 0.9V to 2.2V (MAX2245) to adjust output power. Drive PC below 0.3V to shut down the control loop and put the device in standby mode.
A2	V _{CC2}	DC Supply-Voltage Connection for the 2nd Stage
A3, B2, C1, C3	GND	Ground Connection. Connect to the PC board ground plane. Provide inductance connection as low as is practical to the ground plane.
B1	RFIN/ $\overline{\text{SHDN}}$	RF Input and Digital Shutdown Control Input. RF path internally DC-blocked and matched to 50 Ω . Digital shutdown path is connected to the bias circuitry through a resistor.
B3	RFOUT	PA Open-Collector Output. Requires external pullup inductance for V _{CC} bias and external matching network for optimum output power and efficiency.
C2	V _{CC1}	DC Supply-Voltage Connection for the 1st Stage, Bias, and Control Circuitry

Detailed Description

The MAX2244/MAX2245/MAX2246 are nonlinear PAs guaranteed to operate over a 2.4GHz to 2.5GHz frequency range from a 3V to 3.6V single supply. The MAX2244/MAX2245 provide 22dBm output power, and the MAX2246 provides 20dBm output power at the highest power setting. The signal path consists of three amplifier stages: an input amplifier stage with adjustable gain, and two fixed-gain amplifier stages.

The PAs have a dual-function input (RFIN/ $\overline{\text{SHDN}}$) for the RF input signal and shutdown control. The shutdown function is controlled with CMOS level signals, with a logic low putting the PA into low-current shutdown. The RF input is internally matched to 50 Ω , eliminating the need for external matching.

The MAX2244/MAX2245/MAX2246 have interstage matching to optimize output power and efficiency. The last amplifier stage is open collector using an external pullup inductor or RF choke. The output match for the PAs also acts as a lowpass filter that attenuates harmonics.

These PAs provide closed-loop power control to provide a stable output power with variations in temperature, V_{CC}, and RF input power. The control amplifier varies the gain of the first stage to equalize the power-control voltage and the internal power-detector output. The MAX2244/MAX2246 have a 0.5V to 2V power-control voltage range, and the MAX2245 has a 0.9V to 2.2V power-control voltage range.

The internal bias circuit provides separate bias voltages and currents to the amplifier stages. An internal lowpass RC filter isolates the bias currents, preventing them from being corrupted by the RF signals. The bias circuit design also ensures the stability of the PA when connected to high VSWR loads over all power levels.

Applications Information

Power-Supply Connections

The MAX2244/MAX2245/MAX2246 are designed to operate from a single, positive supply voltage (V_{CC}) with three connections made to V_{CC}: V_{CC1}, V_{CC2}, and RFOUT bias. Join the V_{CC} traces together using a star layout, which reduces crosstalk and promotes stable operation. At the common point of the star, connect 10 μ F and 10nF decoupling capacitors to ground to reduce noise and handle current transients. Additionally, each leg requires a high-frequency bypass capacitor and a 1nF power-supply decoupling capacitor near the IC.

High-frequency bypass capacitors are required close to the IC. For V_{CC1}, connect a capacitor approximately 1mm from the V_{CC1} pad. The distance of the capacitor from the pad affects the impedance at V_{CC1}, which affects output power of the first stage. For optimal output power from stage 1, V_{CC1} requires 0.3nH to 0.4nH inductance.

The output power of the second stage is affected by the impedance presented to V_{CC2}, which is controlled by the distance between the V_{CC2} pad and its bypass capacitor. For optimal electrical distance, see Figure 1 and Table 1.

RFOUT must be pulled up to V_{CC} through an inductor or an inductive transmission line. If using a transmission line, a high-frequency bypass capacitor from V_{CC} to ground is necessary to terminate the transmission line and set its electrical length. The inductance formed by the length of the transmission line is part of the output-matching network, and therefore is critical. See the *Output Matching* section for more information on RFOUT requirements.

2.5GHz, 22dBm/20dBm Power Amplifiers with Analog Closed-Loop Power Control

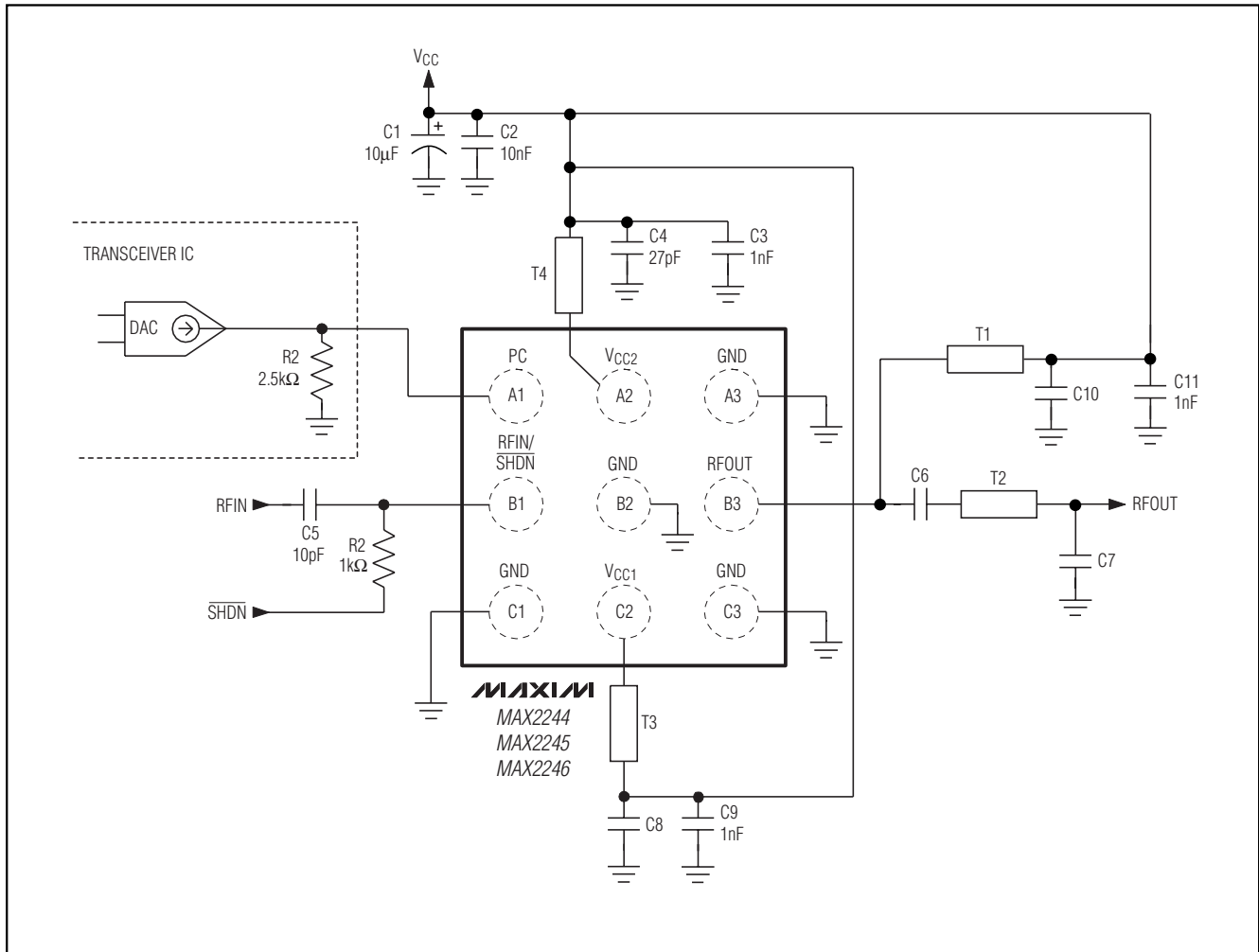

Figure 1. MAX2244/MAX2245/MAX2246 Typical Application Circuit

Table 1. Typical Application Circuit Component Values

COMPONENT	MAX2244	MAX2245	MAX2246
C6	10pF	5.6pF	10pF
C7	1.2pF	1.2pF	1.3pF
C8	5pF	5pF	27pF
C10	100pF	100pF	27pF
T1	50Ω, 17.6°	50Ω, 18°	50Ω, 25°
T2	50Ω, 50°	50Ω, 53°	50Ω, 50°
T3	50Ω, 5.3°	50Ω, 5.3°	50Ω, 5.3°
T4	50Ω, 5.3°	50Ω, 5.9°	50Ω, 8.9°

Note: Electrical lengths given for 2.4GHz.

Place the 1nF power-supply decoupling capacitors between the star connection and the smaller bypass capacitors and close to the IC. Larger trace lengths between the decoupling capacitors and the IC increase the parasitic trace inductance, which, when combined with the capacitors on VCC1 and VCC2, can form an LC tank and introduce instability in the MHz range. If this happens, you can add a small-value resistor (~10Ω), between the 1nF capacitor and ground to de-Q the capacitor and dampen the oscillation.

2.5GHz, 22dBm/20dBm Power Amplifiers with Analog Closed-Loop Power Control

MAX2244/MAX2245/MAX2246

RF Input/SHDN

RFIN/SHDN is a dual-function input for a 2.4GHz to 2.5GHz RF signal and a DC-coupled shutdown function. The input port is internally matched to 50Ω, making it simple to interface the PAs to a 50Ω source without external matching components. The PAs are designed to amplify input signal levels of 0 to 4dBm and, although the PAs function for input signals outside this range, output power and efficiency degrade. **Note:** Ensure that the RF signal is present at the input when the PA is enabled. If the RF signal is not present at startup, the PA functions like any closed-loop control system and automatically goes into a high-gain state, amplifying and transmitting noise. Avoid this mode of operation.

The second function of the RFIN/SHDN is shutdown control. A DC voltage at the input port digitally controls the on/off state with standard CMOS levels. The PA is in low-current shutdown when the DC voltage is a valid logic low and is active for a valid logic high. Connect the SHDN signal to the RFIN/SHDN through a 1kΩ resistor. Connect the RF signal to the RFIN/SHDN with a 10pF capacitor in series to block any DC from corrupting the SHDN signal.

Output Matching

The output structure of these nonlinear PAs is an open-collector transistor that requires external impedance matching and pullup inductance for biasing. The recommended output matching network is shown in the *Typical Application Circuits* (Figure 1). The impedance presented to the RFOUT pin is shown in Figure 2 and Table 2. This impedance is specified relative to a reference plane at the amplifier output into the matching network and load.

The matching network is for impedance transformation that transforms 6Ω to 50Ω with the specified maximum output power. The network also forms a lowpass filter that provides attenuation for the 2nd and 3rd harmonics. A shunt capacitor (C7) is needed to perform the transformation, and the inductive 50Ω transmission line (T2) is needed to match that capacitance. A larger capacitor can be used to increase the maximum output power, but the transmission line also must be increased to maintain a match with C7. A DC-blocking capacitor (C6) of 5pF to 10pF is necessary between the PA output and the transmission line.

The pullup inductance from RFOUT to VCC serves three main purposes: it resonates out the capacitive PA output, provides biasing for the output stage, and becomes a high-frequency choke to reduce RF energy from coupling into VCC. The pullup inductance normally is a 50Ω transmission line (T1); however, chip inductors can be used instead. The typical application circuit terminates the transmission line with a capacitor (C6).

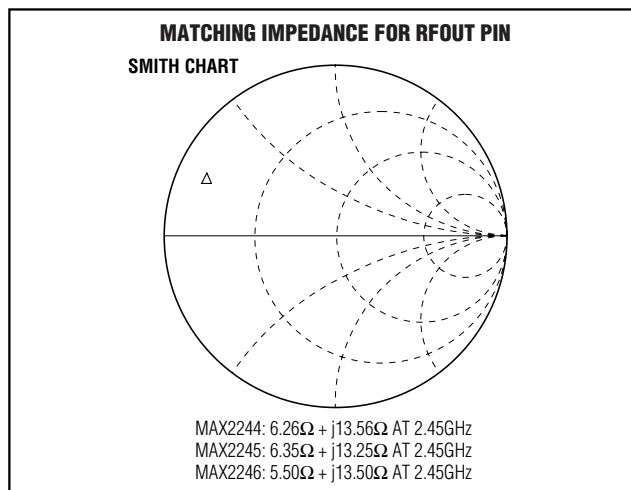

Figure 2. Impedance of Matching Network at RFOUT Pin

Table 2. Matching Network Impedance

FREQUENCY GHz	MAX2244		MAX2245		MAX2246	
	REAL (Ω)	IMAG (Ω)	REAL (Ω)	IMAG (Ω)	REAL (Ω)	IMAG (Ω)
2.40	6.47	13.2	6.61	12.94	5.73	13.01
2.45	6.26	13.5	6.35	13.25	5.50	13.50
2.50	6.06	13.9	6.11	13.59	5.27	14.02

Analog Power Control (PC)

The PAs use a closed-loop power-control system for consistent output power across input power, supply voltage, and temperature. Output power is internally monitored and compared to the desired setting on PC. The control amplifier then adjusts the first-stage variable-gain amplifier until the output power matches the desired setting. The result is that the output power is controlled by the voltage applied to PC.

The power-control voltage range at PC for the MAX2244/MAX2246 is 0 to 2V. Output power remains at its minimum for V_{PC} between 0 and 0.4V. At approximately 0.4V, output power increases exponentially until V_{PC} = 2V, where output power is 22dBm (MAX2244) or 20dBm (MAX2246). See Figures 3a and 3c for the relationship between V_{PC} and output power for the MAX2244 and MAX2246, respectively.

Likewise, the MAX2245 output power is controlled by V_{PC}, but with a different power-control range. The power-control voltage range of the MAX2245 is 0 to 2.2V, with output power beginning to increase when V_{PC} = 0.9V. Figure 3b shows the V_{PC} and output power relationship for the MAX2245.

2.5GHz, 22dBm/20dBm Power Amplifiers with Analog Closed-Loop Power Control

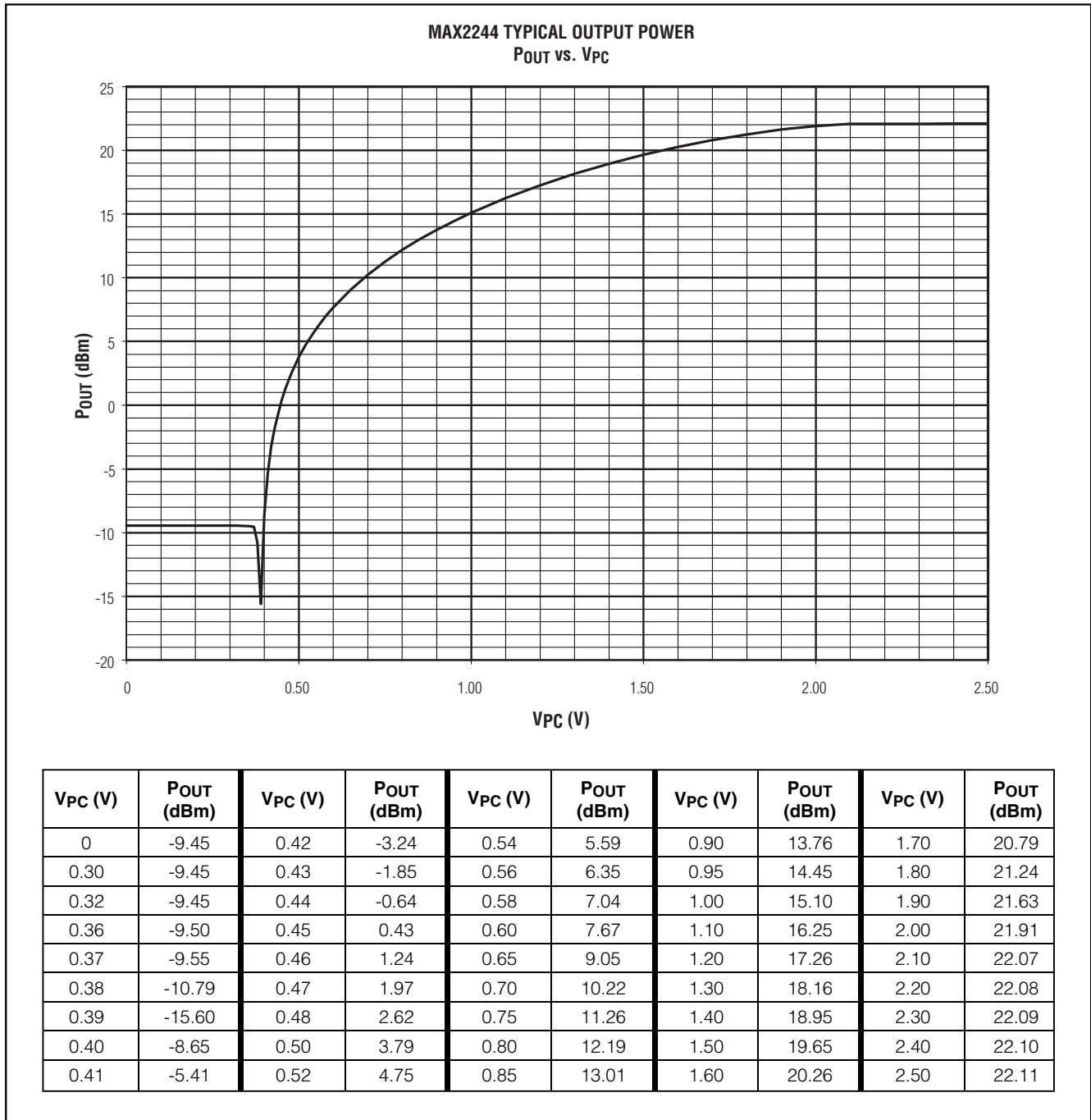

Figure 3a. MAX2244 Typical Output Power vs. Power-Control Voltage

2.5GHz, 22dBm/20dBm Power Amplifiers with Analog Closed-Loop Power Control

MAX2244/MAX2245/MAX2246

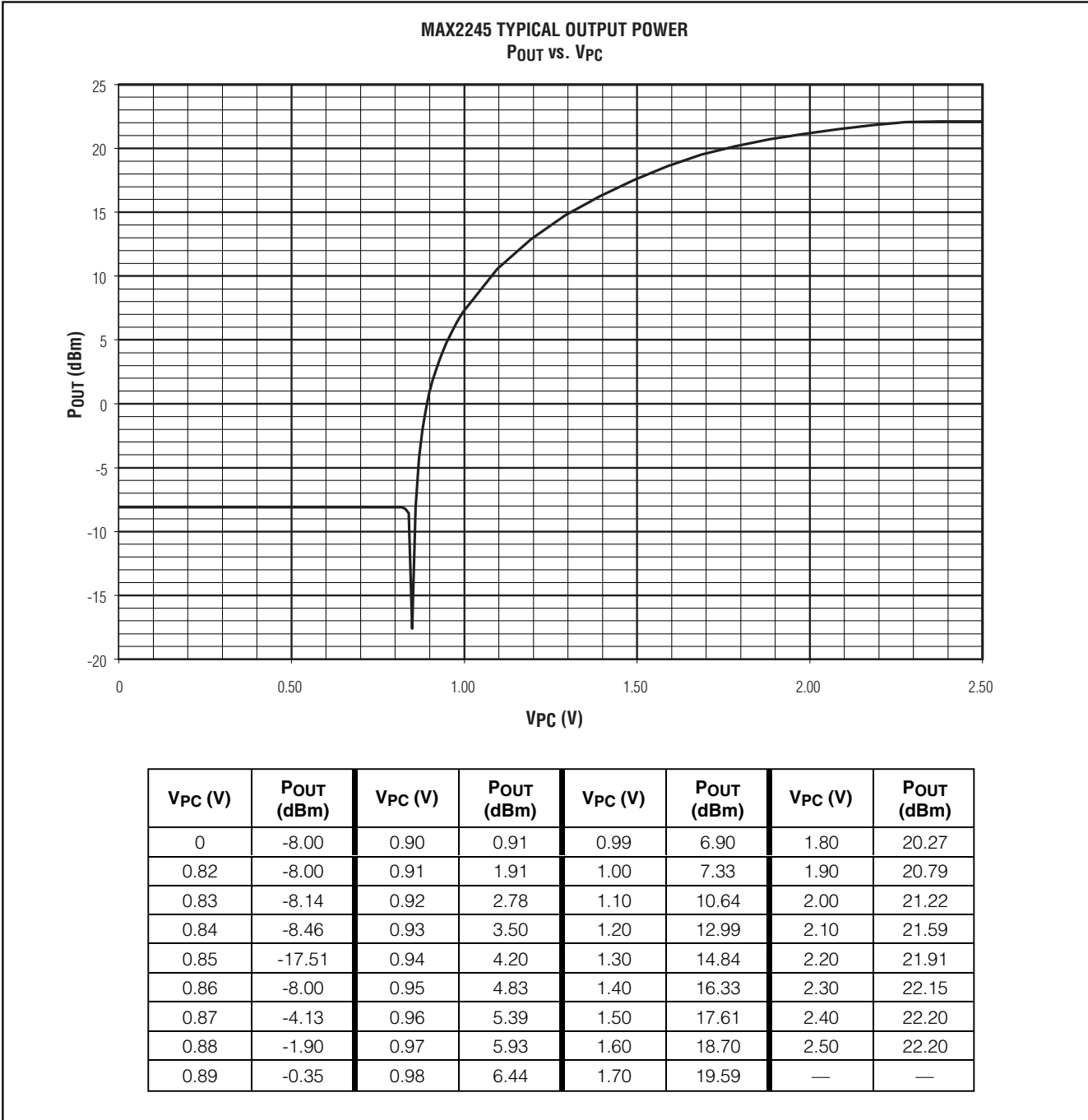

Figure 3b. MAX2245 Typical Output Power vs. Power-Control Voltage

2.5GHz, 22dBm/20dBm Power Amplifiers with Analog Closed-Loop Power Control

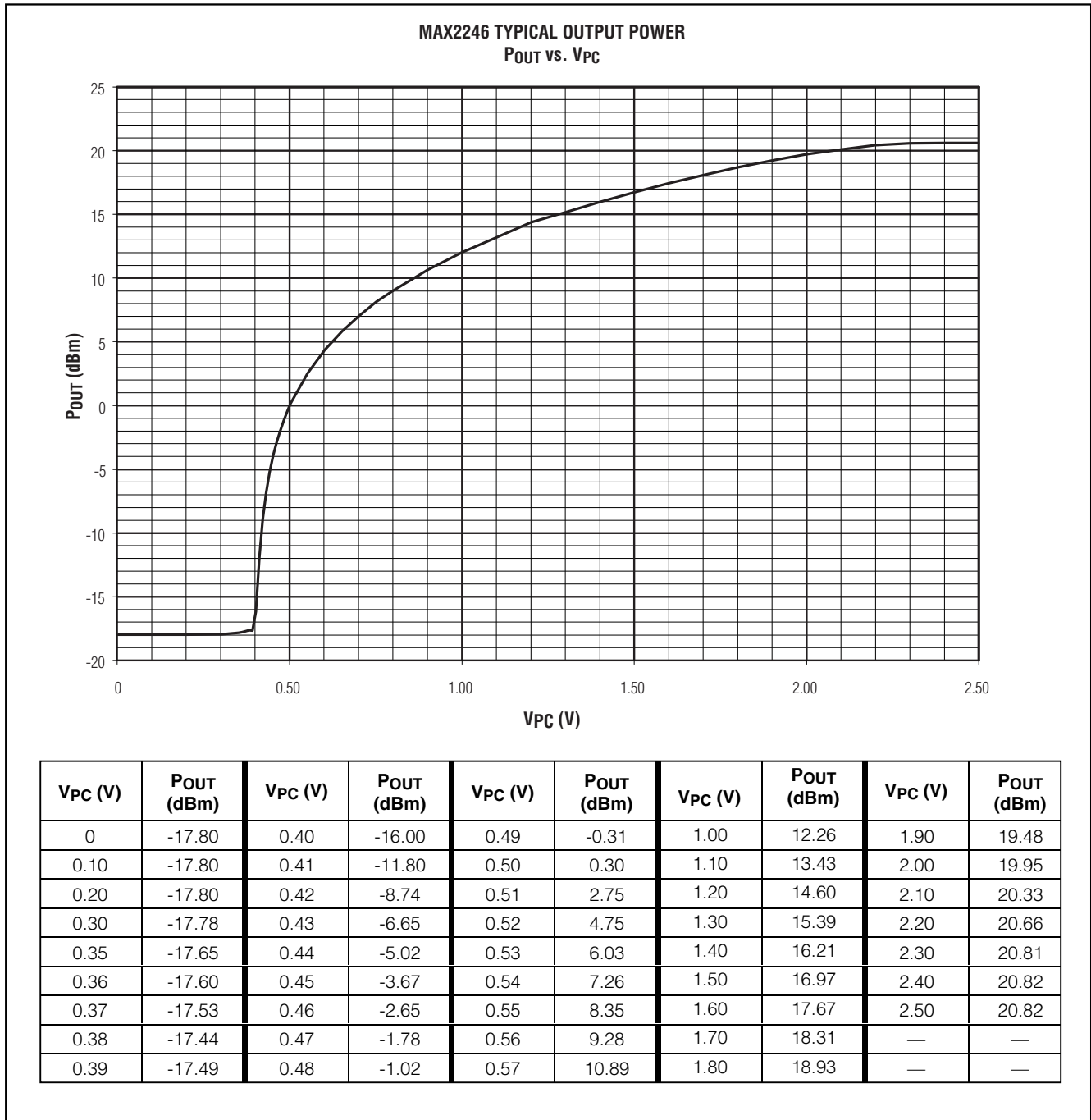

Figure 3c. MAX2246 Typical Output Power vs. Power-Control Voltage

2.5GHz, 22dBm/20dBm Power Amplifiers with Analog Closed-Loop Power Control

MAX2244/MAX2245/MAX2246

Layout

A good layout is necessary to achieve high-output power with good efficiency. A solid ground plane must be used, with any free board space also being grounded. Connect any ground planes using multiple vias and low-inductance connections. Parasitic inductance reduces output power and efficiency, so place the ground return of the chip components as close to the IC as possible. The MAX2244 EV kit and MAX2246 EV kit PC boards use via-on-pad for low-inductance connections.

Use a star connection for the power-supply traces that connect to VCC1, VCC2, and RFOUT. At a common point of the power-supply traces, connect 10nF and 10μF decoupling capacitors to ground. Place 1nF capacitors closer to the IC on each VCC trace with the small value matching capacitors closest to the IC. The distance of the matching capacitors from the IC is critical. See the *Power Supply Connections* section for more information.

The layout of the output section is important because 50Ω traces are used as part of the matching. See the *Output Matching* section for component information. The 50Ω traces can be bent, but be aware of how the characteristics of the transmission line change, and compensate for them accordingly.

Use a 50Ω line to directly connect to the input. Place one pad of the 1kΩ resistor for the SHDN signal directly on the 50Ω line or as close to the line as possible. Any trace connected to the 50Ω line changes the line's characteristic impedance, causing power loss. The layout of the trace connecting PC is noncritical.

The chip-scale IC package uses a bump pitch of 0.5mm (19.7 mil) and a bump diameter of 0.3mm (~12 mil). Therefore, lay out the solder pad spacing on 0.5mm (19.7 mil) centers. Use a pad size of 0.25mm (~10 mil) and a solder mask opening of 0.33mm (13 mil). Round or square pads are permissible. Refer to the Maxim document, *Wafer Level Ultra-ChipScale Packaging*, for detailed information on UCSP layout and handling.

Prototype Chip Installation

Alignment keys on the PC board around the chip are helpful in prototype assembly. The MAX2244 and MAX2246 EV kit PC boards have L-shaped alignment keys at the diagonal corners of the chip. Align the chip on the board before any other components are placed, and place the board on a hotplate or hot surface until the solder starts melting. Remove the board from the hotplate without disturbing the position of the chip. Let it cool to room temperature before further processing the board.

Marking Information

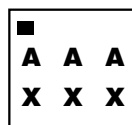

■ Pin 1 ID
 AAA: Product ID Code
 XXX: Lot Code

UCSP Reliability

The UCSP is a unique package that greatly reduces board space compared to other packages. UCSP reliability is integrally linked to the user's assembly methods, circuit board material, and usage environment. Closely review these areas when considering using a UCSP.

Performance through Operating Life Test and Moisture Resistance remains uncompromised as they are primarily determined by the wafer-fabrication process. Mechanical stress performance is a greater consideration for a UCSP. UCSP solder-joint contact integrity must be considered because the package is attached through direct solder contact to the user's PC board. Testing to characterize the UCSP reliability performance shows that it is capable of performing reliably through environmental stresses. Results of environmental stress tests and additional usage data and recommendations are detailed in the UCSP application note, available on Maxim's website, www.maxim-ic.com.

Users should also be aware that, as with any interconnect system there are electromigration-based current limits that, in this case, apply to the maximum allowable current in the bumps. Reliability is a function of this current, the duty cycle, lifetime, and bump temperature. See the *Absolute Maximum Ratings* section for any specific limitations, listed under Continuous Operating Lifetime.

Chip Information

TRANSISTOR COUNT: 727

PROCESS: Bipolar

Pin Configuration

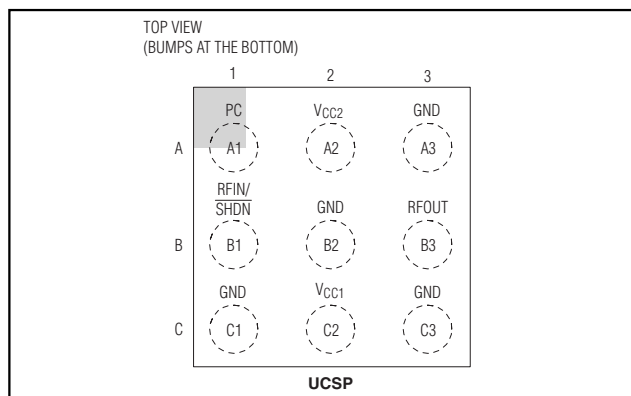

2.5GHz, 22dBm/20dBm Power Amplifiers with Analog Closed-Loop Power Control

Package Information

(The package drawing(s) in this data sheet may not reflect the most current specifications. For the latest package outline information, go to www.maxim-ic.com/packages.)

TOP VIEW

COMMON DIMENSIONS		VARIABLE DIMENSIONS		DEPOPULATED SOLDER BALLS	
		D	E		
A	0.62±0.05-0.08				
A1	0.29±0.02	B9-1	1.52±0.05	1.52±0.05	NONE
A2	0.33 REF.	B9-2	1.52±0.05	1.52±0.05	B2
b	∅0.35±0.03	B9-3	1.52±0.05	1.52±0.05	B1, B2, B3
D1	1.00 BASIC	B9-4	1.60±0.05	1.60±0.05	NONE
E1	1.00 BASIC	B9-5	1.60±0.05	1.60±0.05	B2
e	0.50 BASIC	B9-6	1.60±0.05	1.60±0.05	B1, B2, B3
SD	0.00 BASIC				
SE	0.00 BASIC				

NOTES:
 1. ALL DIMENSIONS ARE IN MILLIMETERS.
 2. PRODUCT MARKING: NUMBER OF CHARACTERS AND LINES VARY PER PRODUCT.

BOTTOM VIEW

SIDE VIEW

PROPRIETARY INFORMATION TITLE: PACKAGE OUTLINE, 3x3 UCSP			
APPROVAL	DOCUMENT CONTROL NO. 21-0093	REV. 1	1/1

9LUCSP, 3x3EFS

Maxim cannot assume responsibility for use of any circuitry other than circuitry entirely embodied in a Maxim product. No circuit patent licenses are implied. Maxim reserves the right to change the circuitry and specifications without notice at any time.

14 Maxim Integrated Products, 120 San Gabriel Drive, Sunnyvale, CA 94086 408-737-7600

MAX2244

Part Number Table

Notes:

1. See the [MAX2244 QuickView Data Sheet](#) for further information on this product family or download the [MAX2244 full data sheet](#) (PDF, 328kB).
2. Other options and links for purchasing parts are listed at: <http://www.maxim-ic.com/sales>.
3. [Didn't Find What You Need?](#) Ask our applications engineers. Expert assistance in finding parts, usually within one business day.
4. Part number suffixes: T or T&R = tape and reel; + = RoHS/lead-free; # = RoHS/lead-exempt. More: See [full data sheet](#) or [Part Naming Conventions](#).
5. * Some packages have variations, listed on the drawing. "PkgCode/Variation" tells which variation the product uses.

Part Number	Free Sample	Buy Direct	Package: TYPE PINS SIZE DRAWING CODE/VAR *	Temp	RoHS/Lead-Free? Materials Analysis
MAX2244EBL-T10					RoHS/Lead-Free: No
MAX2244EBL			UCSP;9 pin; Dwg: 21-0093L (PDF) Use pkgcode/variation: B9-1*	0C to +70C	RoHS/Lead-Free: No Materials Analysis
MAX2244EBL-T			UCSP;9 pin; Dwg: 21-0093L (PDF) Use pkgcode/variation: B9-1*	0C to +70C	RoHS/Lead-Free: No Materials Analysis

[Didn't Find What You Need?](#)

[CONTACT US: SEND US AN EMAIL](#)

Copyright 2007 by Maxim Integrated Products, Dallas Semiconductor • [Legal Notices](#) • [Privacy Policy](#)