

FM3540/60

4/5 Bit Multiplexed, 1 Bit Latched Port with Standard 2-Wire Bus Interface and Non-Volatile Latches

General Description

The FM3540/60 multiplexes the I-port input signals with two internal non-volatile registers that can be loaded through the serial port. The multiplexer is selected via the serial port and defaults to the I-Port upon power-up. Pull-up resistors are provided on the input port to accommodate connections to open drain outputs and to eliminate the need for external resistors. The device supports a choice of either 2.5V output or Open Drain Outputs for easy interface to devices with different VDD Levels.

The serial port is an IIC compatible slave only interface and supports both 100kbps and 400kbps modes of operation. The port is used to read the I-Port, Write Data to the internal non-volatile

registers and select whether the I-Port or one of the internal non-volatile registers is output to the Y-port. The FM3540/60 is fabricated with an advanced CMOS technology to achieve high density and low power.

Features

- Extended Operating Voltage Range 3.0V-5.5V
- IIC Compatible Slave Interface.
- ESD performance: Human body model > 2000V
- Choice of 2.5V outputs or Open-Drain Outputs

Block Diagram

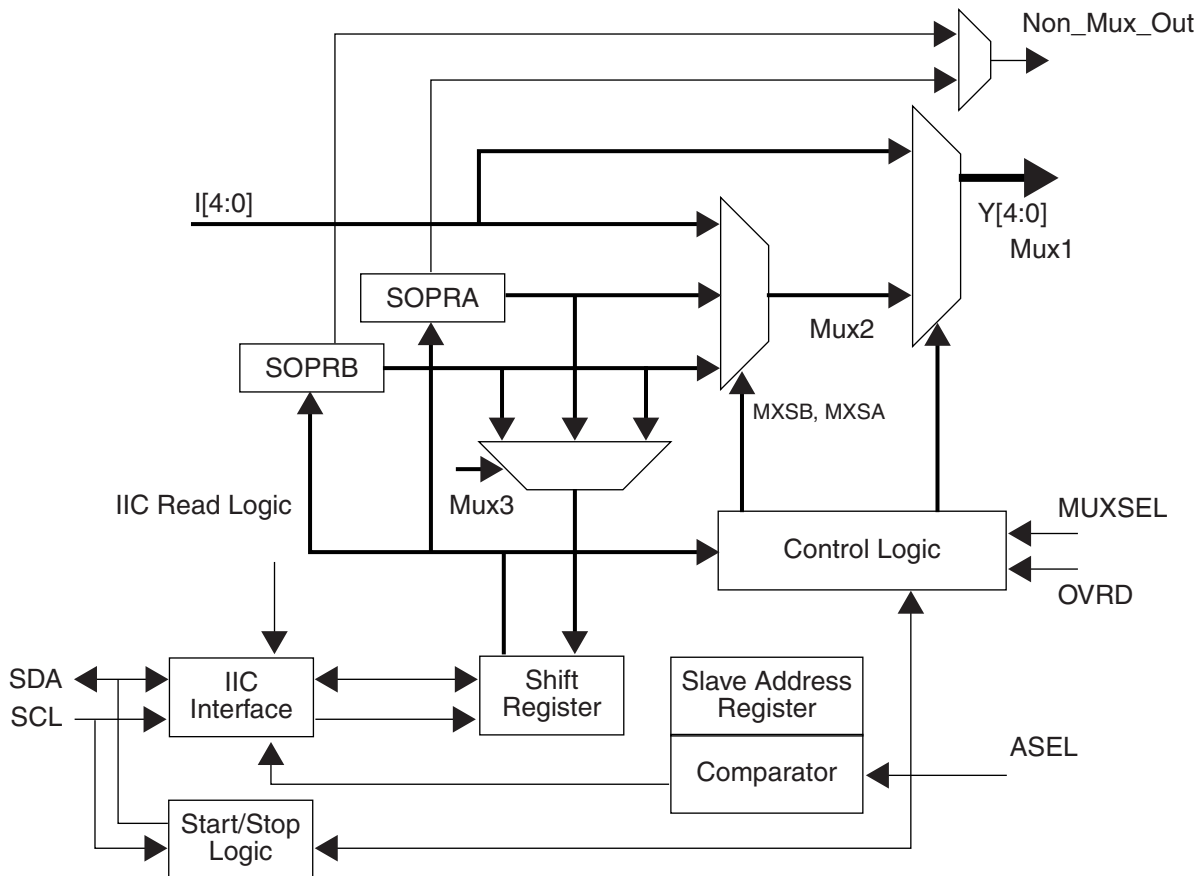

Ordering Information

Order Number	Package Number	Package Description	Packing	Y-Port Output Type	Device Address
FM3540CM14	M14A	14-Pin SO	T&R	Open-Collector	1001110
FM3540CMT14	MTC14	14-Pin TSSOP	T&R	Open-Collector	1001110
FM3540SM14	M14A	14-Pin SO	T&R	Fixed 2.5V	1001110
FM3540SMT14	MTC14	14-Pin TSSOP	T&R	Fixed 2.5V	1001110
FM3560M20	M20B	20-Pin SO	T&R	(See Note below)	(See Note below)
FM3560MT20	MTC20	20-Pin TSSOP	T&R	(See Note below)	(See Note below)

Note About Y-Port Output Type:

FM3560 device has a dedicated input pin (LEVEL) to select either "Fixed 2.5Volts" or "Open-Collector" Y-Port output type.

Note About Device Address:

- For FM3540 with an alternate device address of 0110111, contact Fairchild Marketing/Sales.
- FM3560 device has a dedicated input pin (ASEL) to select either "1001110" or "0110111" as device address.

Pin Connection Diagrams

**14-Pin Packages
FM3540**

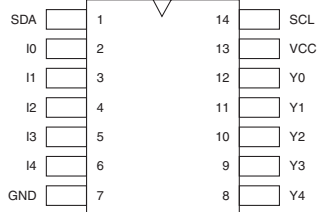

**20-Pin Packages
FM3560**

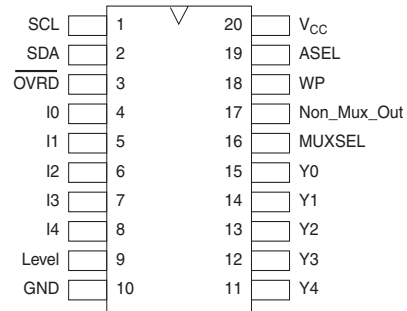

Pin Description

Pin Name	Description
I[0:4]	Data Inputs w/Pullups (10K-40K)
Y[0:4]	O/D Data Outputs
SCL	Serial Port Clock Input (120K pullup)
Override#	Override Input, sets all outputs to 0
WP	Write Protect Input
Non_Mux_Out	Non-Multiplexed Output
Mux_Sel	Mux. Select Input
Level	Level Select Input
ASEL	Address Select Input
SDA	Serial Port Data I/O (120K pullup)

Functional Description

The FM3540/60 has two primary functional modes of operation and an additional mode for programming the device.

Operational Modes

During standard operation the device will either pass an address to the Y-Port from the I-Port or from an internally programmed value. At power up the device will default to passing the I-Port value to the Y-Port.

The I-port values are generated from the motherboard of the system and may be hardwired or driven by another device. Pull-up resistors are provided on the device to accommodate this device being driven by open drain output drivers. The device expects standard CMOS input signals. The level of the output signal is determined by the Level input. If this input is connected to Vss/Ground, the output is at 2.5V on the multiplexed outputs (Y0-Y4). The non-multiplexed output is always at CMOS levels. The Level input, if left unconnected (it has an internal pullup), will cause the Y0-Y4 outputs to operate as open-drain outputs. The override# input, when set to 0, will cause all the outputs to be set to 0. The WP signal, if set to logic 1, will prevent data from being written to the non-volatile register.

The mux_sel input, when set to logic 0, will select the data from the non-volatile register to drive on the Y0-4 outputs. If set to logic 1, the data from the inputs are selected instead. The non_mux_out latch is transparent when the mux_sel signal is at logic 0, and will latch data when the mux_select is in a logic 1 state.

Output Port: Y0-Y4

The output port is an open drain output to allow for easy connection to devices running at different voltage levels. The port is always active and either passes the value on the I-Port or the value in the Serial output port Register (SOPR). Changing the Mux Path is accomplished by writing to b7, b6 of the Serial Input Port Register. SOPR-b7, b6 defaults to a value of "10" at power up and the default path is from the I-Port through to the output port. The multiplexer only updates when an IIC stop condition is observed.

Register Description

The FM3540/60 has 3 registers in total. These registers are made up of a combination of read only, write only and read write bits. The two registers are listed below.

Serial Output Port Register A(SOPRA) Address: 00H - A read/write register that contains the new value to be written to output Port-Y and the multiplexer select bit.

Serial Output Port Register B(SOPRB) Address: 01H - A read/write register that contains the new value to be written to output Port-Y and the multiplexer select bit.

Parallel Input Port Register (PIPR) Address: 02H - A read only register that is loaded with the 5 bit value of the I-Port.

Serial Output Port Register (SOPR)

(Address 000b and 001b)

MXSB	MXSA	Data Field					
0	0	I5	NMO	I3	I2	I1	I0
b7	b6	b5	b4	b3	b2	B1	b0

b7-b6 - Multiplexer Select Bits (MXSB,MXSA)

00 - Multiplexer passes the SOPR(A).

01 - Multiplexer passes the SOPR(B).

10 - Multiplexer defaults to passing the I-Port Value.

b5, b3-b0 - Data Field. New value to be output through the multiplexer.

nmo - Non multiplexed output from internal non-volatile bit

Parallel Input Port Register (PIPR)

(Address 002b)

Address Field			Data Field				
0	0	0	I4	I3	I2	I1	I0
b7	b6	b5	b4	b3	b2	B1	b0

b7-b5 - Address field. Value is always 000

b4-b0 - Data Field. Value is equal to the value on the I-Port.

The external Port Register captures the value on the I-Port. Data is latched into this register on the first clock after a start condition is seen. This insures that a valid value will always be in this register if it is read. This register is a read only register with respect to the IIC port.

Over-ride#	mux_sel	MXSB	MXSA	mux_outputs	Non_mux_output
0	0	X	X	all 0's	all 0's
0	1	X	X	Mux_inputs (see note 1)	latched NMO
1	0	1	0	Mux_inputs (see note 1)	latched NMO
1	0	0	0	From Non-volatile register (SOPRA)	From non-volatile register (SOPRA)
1	0	1	1	Do not use this combination	
1	0	0	1	From Non-volatile register (SOPRB)	From non-volatile register (SOPRB)
1	1	Note 2	Note 1	Mux_inputs	From Non-volatile register (SOPRA or SOPRB)

Note 1: Latched NMO state will be the value present on the NMO output at the time of the mux_sel input transitioning from logic 0 to logic 1 state.

Note 2: Output depends on previously selected state of MXSB and MXSA bits written to device.

Multiplexer Logic

The output multiplexer logic determines what value is actually output to the Y-port. The value that is output is dependent upon b7-b6 of the SOPRA and SOPRB registers, as well as the external mux_sel and override# inputs. There is only one set of MXS bits in the SOPRA and SOPRB registers. Regardless of whether one writes to SOPRA or SOPRB register for setting the MXS bits, the result is the same. These same bits appear in both the registers. If the mux_sel is logic 0 and OVRD is logic 1, then, if b7,b6 is "10" then the value on the I-port is passed. When b7 is "00" the value of the SOPRA register is passed on the next IIC stop condition, and .When b7 is "01" the value of the SOPRB register is passed on the next IIC stop condition. If mux_sel is logic 1 and OVRD is logic 1, the input lines I0-4 are used to drive the outputs. The above table describes all the combinations.

IIC Interface

The IIC Interface is a standard slave interface. As a slave interface the device will not generate its own clock. Data can be read from and written into the device. Commands for reading and writing the registers are generated by the IIC Master.

START and STOP Conditions

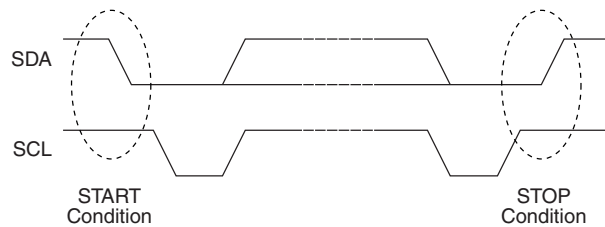

The IIC protocol uniquely defines START and STOP conditions. A START condition is defined as a HIGH to LOW transition of the SDA signal while SCL is HIGH. A STOP condition is defined as a LOW to HIGH transition of the SDA signal while SCL is HIGH. These are shown in Figure 2.

Device Addressing

The device uses 7 bit IIC addressing. The address has been defined as 1001 110 if the ASEL input is '1' and 0110 111 if the ASEL input is '0'. The address byte is the first byte of data sent after a start condition. This is the only address that this device will respond to. The device will not respond to the general call address 0000 000.

Reading from the Registers

Data can be read from both of the internal registers. All reads are non-destructive and do not change the value in the register or the internal state of the device. When a start condition is received with a read request both registers can be read out in the following sequence.

- (1) SOPRA - Serial Output Port Register A
- (2) SPORB - Serial Output Port Register B
- (3) PIPR - PORT-I Value

If so desired only the SOPRA register can be read. This is accomplished by issuing a stop command after acknowledge bit for the first byte read. If no stop is issued, the device will output the registers in the above sequence.

Writing to the Registers

Data is written to the SOPR registers through the serial port interface. When a write request is received with the Start Address it is assumed that the intent is to write the SOPR registers. The value placed in the least 6 significant bits of the register contain the new code to be placed in the SOPR A/B registers. The value of the two most significant bits must contain the address of the destination register SOPRA or SOPRB.

The internal non-volatile latch takes about 10 ms to update its data. The new data is reflected on the outputs after the internal non-volatile latch is updated, if the corresponding select bits (MXSx, OVRD and mux_sel) are set to reflect the state of the non-volatile register

Register Read Sequence

S	Slave Address	R	A	SOPRA Register	A	SOPRB Register	A	PIPR Register	A	P
S	1001110	1	A	00bbbbbb	A	00bbbbbb	A	00bbbbbb	A	P

Register Write Sequence

S	Slave Address	W	A	SOPRx Register	A	S
S	1001110	0	A	xxbbbbbb	A	S

xx = Register Selection bits (MXSB and MXSA) xx = 00 selects SOPRA, 01 selects SOPRB

Register Write Sequence using Repeated Start Condition

S	Slave Address	R	A	SOPRA Register	A	S	Slave Address	W	A	SOPRx Register	A	P
S	1001110	1	A	00bbbbbb	A	S	1001110	0	A	xxbbbbbb	A	P

Figure 4

Absolute Maximum Ratings (Note 1)

Supply Voltage (V_{CC})	-0.5V to +6.5V
DC Input Voltage (V_I)	-0.5V to +6.5V
Output Voltage (V_O)	
Outputs 3-STATED	-0.5V to +6.5V
Outputs Active (Note 2)	-0.5 to $V_{CC}+0.5V$
DC Input Diode Current (I_{IK}) $V_I < 0V$	-50mA
DC Output Diode Current (I _{OK})	
$V_O < 0V$	-50mA
$V_O > V_{CC}$	+50mA
DC Output Source/Sink Current (I_{OH}/I_{OL})	±50mA
DC V_{CC} or Ground Current per Supply Pin (I_{CC} or Ground)	±100mA
Storage Temperature Range (T_{STG})	-65°C to +150°C

Recommended Operating Conditions (Note 3)

Power Supply	3.0V to 5.5V
Input Voltage	-0.3V to 5.5V
Output Voltage (V_O)	0V TO V_{CC}
Output Current I_{OL}	3mA
Free Air Operating Temperature(TA)	-0°C to +70°C
Minimum Input Edge Rate (d_T/d_V) $V_{IN} = 0.8V$ to $2.0V$, $V_{CC} = 3.0V$	10nS/V

Note 1: The "Absolute Maximum Ratings" are those values beyond which the safety of the device cannot be guaranteed. The device should not be operated at these limits. The parametric values defined in the "Electrical Characteristics" table are not guaranteed at the Absolute Maximum Ratings. The "Recommended Operating Conditions" table will define the conditions for actual device operation.

Note 2: IO Absolute Maximum Rating must be observed.

Note 3: Floating or unused pins (inputs or I/O's) must be held HIGH or LOW.

DC Electrical Characteristics (4.5V < V_{CC} ≤ 5.5V)

Symbol	Parameter	Conditions	V_{CC} (V)	Min	Max	Units
V_{IH}	High Level Input Voltage		4.5 - 5.5	$V_{CC} \times 0.7$		V
V_{IL}	Low Level Input Voltage		4.5 - 5.5		$V_{CC} \times 0.3$	V
V_{OL}	Low Level Output Voltage	$I_{OL} = 100\mu A$ $I_{OL} = 3mA$	4.5 - 5.5		0.2 0.4	V
I_{IR}	Input Leakage Current	$V_I = V_{IL}$	5.5	-10	+10	μA
I_{CC}	Quiescent Supply Current	$V_I = V_{CC}$ or GND $V_{CC} \leq (V_{AI}, V_{OI}) \leq 3.6V$	4.5 - 5.5	300	975	μA

DC Electrical Characteristics Extended (3.0V ≤ V_{CC} ≤ 5.5V)

Symbol	Parameter	Conditions	V_{CC} (V)	Min	Max	Units
V_{IH}	High Level Input Voltage		3.0 - 5.5	$V_{CC} \times 0.7$		V
V_{IL}	Low Level Input Voltage		3.0 - 5.5		$V_{CC} \times 0.3$	V
V_{OL}	Low Level Output Voltage	$I_{OL} = 100\mu A$ $I_{OL} = 3mA$	3.0 - 5.5		0.2 0.4	V
V_{OH}	Output High Voltage	Fixed output mode, ('s' grade samples, or FM3560 with LEVEL input = logical '0') 1 TTL load, 50pf capacitance	3.0 - 5.5	2.3	2.5	V
I_{IR}	Input Leakage Current	$V_I = V_{IL}$	5.5	-10	+10	μA
I_{CC}	Quiescent Supply Current	$V_I = V_{CC}$ or GND $V_{CC} \leq (V_I, V_O) \leq 3.6V$	3.0 - 5.5	300	975	μA

AC Characteristics

Symbol	Parameter	$T_A = 0^\circ\text{C to } +70^\circ\text{C}, C_L = 30\text{pF}, R_L = 500\Omega$				Units
		$V_{CC} = 5.0\text{V} \pm 0.5\text{V}$		$V_{CC} = 3.3 \pm 0.3\text{V}$		
		Min	Max	Min	Max	
t_{PHL}	Prop Delay I to Y		50		50	ns
T_{PLH}	Prop Delay I to Y		50		50	ns
t_{PHL}	Prop Delay to Y (from OVRD' or Mux_Sel)		50		50	ns
T_{PLH}	Prop Delay to Y (from OVRD' or Mux_Sel)		50		50	ns

IIC AC Characteristics

Symbol	Parameter	$T_A = 0^\circ\text{C to } +70^\circ\text{C}, C_L = 30\text{pF}, R_L = 500\Omega$				Units
		100kHz		400kHz		
		Min	Max	Min	Max	
f_{SCL}	SCL Clock Frequency		100		400	kHz
T_1	Noise Supression Time Constant		100		50	nS
t_{AA}	SCL Low to SDA Data Out Valid	0.3	3.5	0.1	0.9	μS
t_{BUF}	Time the Bus must be free before a new Transmission can start	4.7		1.3		μS
$t_{HD:STA}$	Start Condition Hold Time	4.0		0.6		μS
t_{LOW}	Clock Low Period	4.7		0.6		μS
t_{HIGH}	Clock High Period	4.0		0.6		μS
$t_{SU:STA}$	Start Condition Setup Time (For a repeated Start Condition)	4.7		0.6		
$t_{HD:DAT}$	Data in Hold Time	0		0		μS
$t_{SU:DAT}$	Data in Setup Time	250		100		nS
t_R	SDA and SCL Rise Time		1000		300	nS
t_F	SDA and SCL Fall Time		300		300	nS
$t_{SU:STO}$	Stop Condition Setup Time	4.7		0.6		μS

Capacitance

Symbol	Parameter	Conditions	$T_A = +25^\circ\text{C}$ Typical	Units
C_{in}	Input Capacitance (I4-I0)	$V_I = 0\text{V}$ or V_{CC} , $V_{CC} = 3.3$ or 5.0	6	PF
$C_{I/O}$	Input/Output Capacitance (SDA)	$V_I = 0\text{V}$ or V_{CC} , $V_{CC} = 3.3$ or 5.0	7	PF
C_{OUT}	Output Capacitance (Y4-Y0)		7	PF

Non-Volatile Memory Characteristics

Parameter	Specification
Data Retention	10 years minimum
Number of writes	1,000,000 cycles

Physical Dimensions inches (millimeters) unless otherwise noted

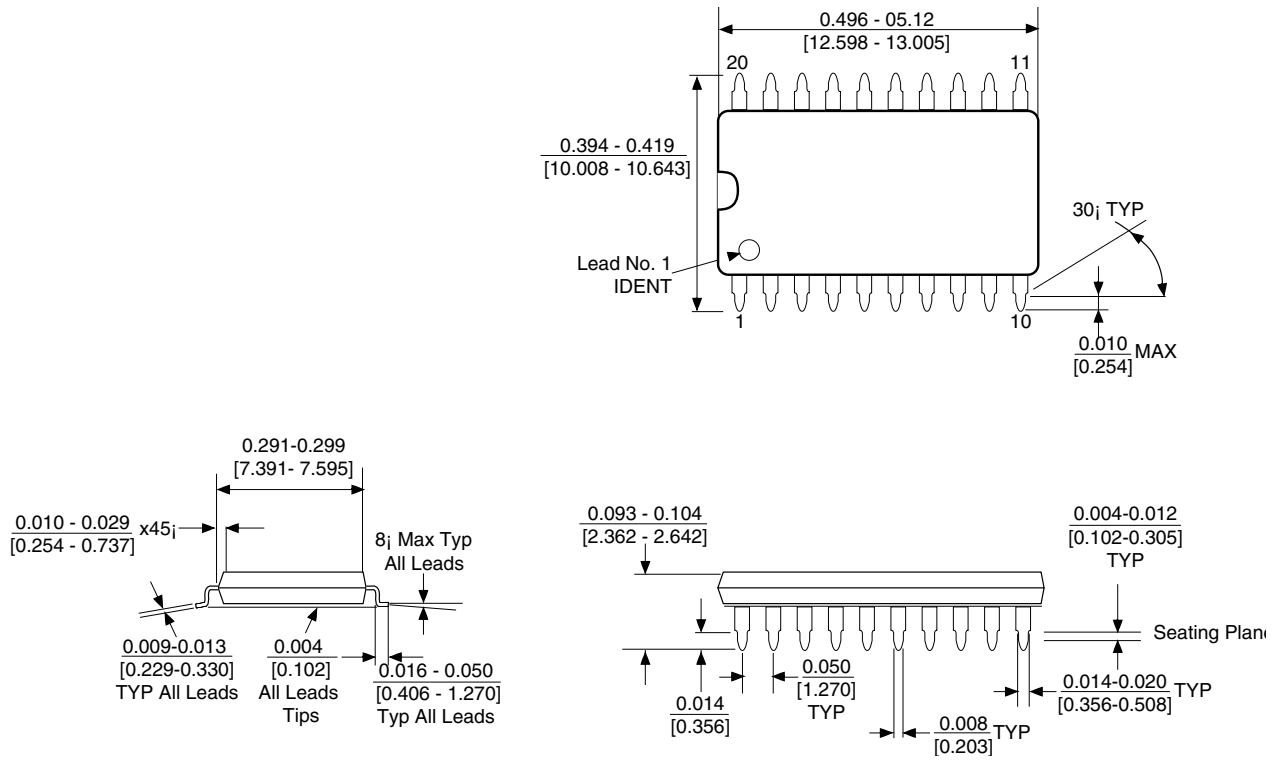

Molded Small Outline Package (M)
Order Number FM3560XM
Package Number M20B

X = C for open collector
 and X = S for 2.5V

Physical Dimensions inches (millimeters) unless otherwise noted

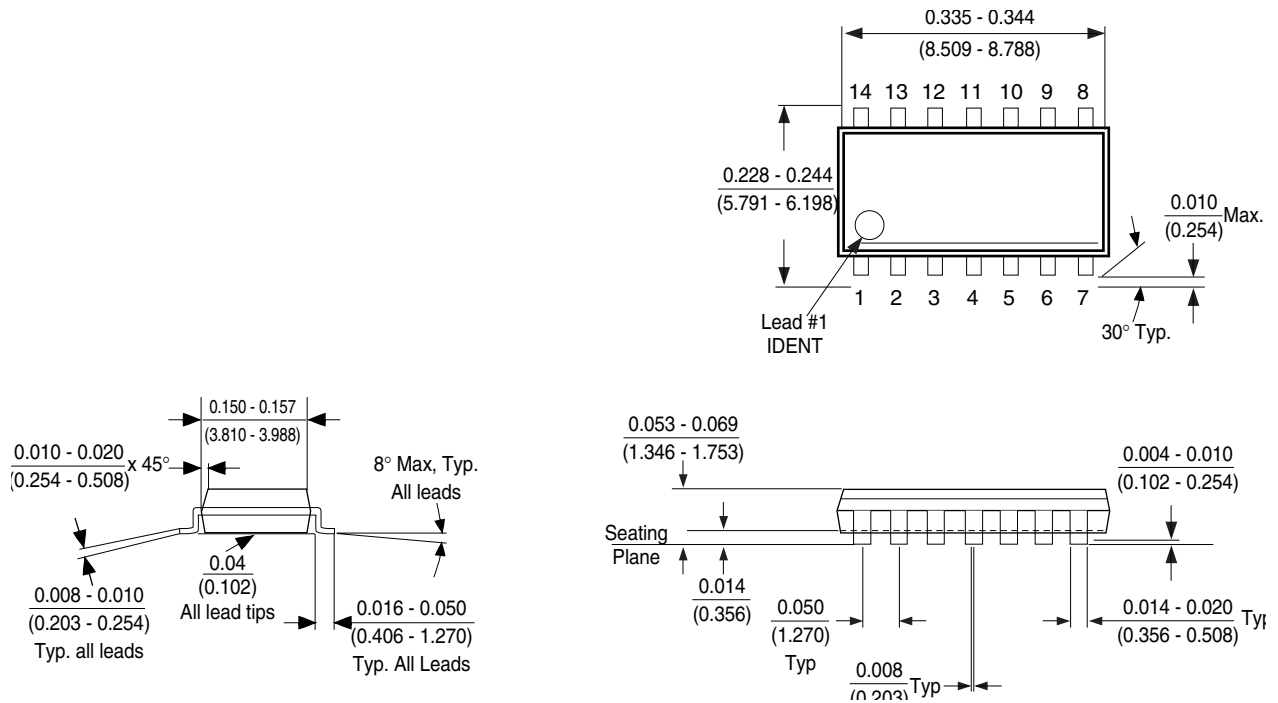

Molded Small Outline Package (M)
Order Number FM3540XM
Package Number M14A

X = C for open collector
 and X = S for 2.5V

Physical Dimensions inches (millimeters) unless otherwise noted

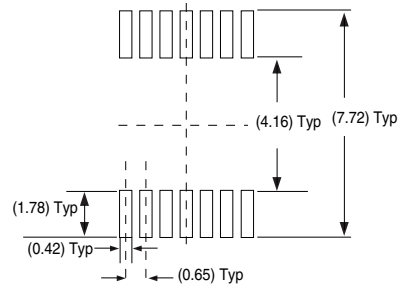
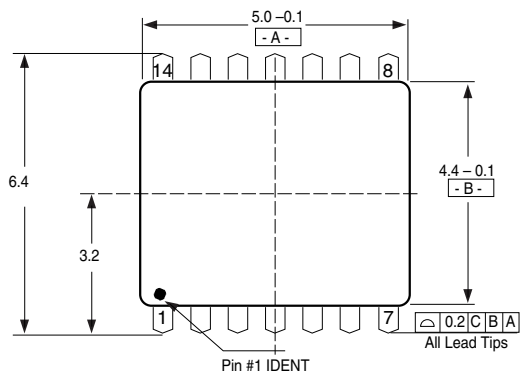

Land pattern recommendation

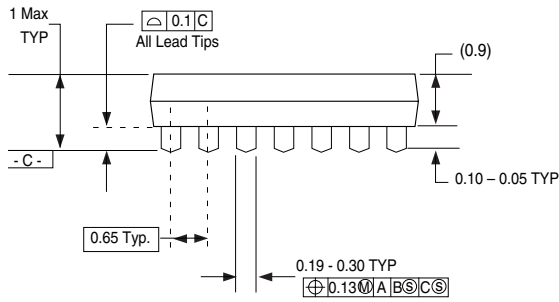

Dimensions are in millimeters

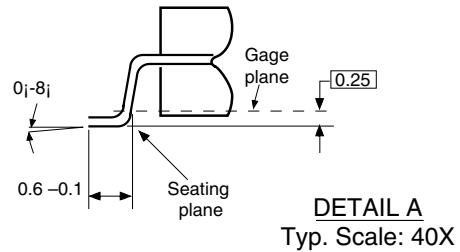
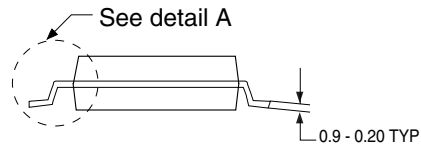

Notes: Unless otherwise specified

1. Reference JEDED registration MO153. Variation AB.
Ref. Note 6, dated 7/93

Order Number FM3540XMT
Package Number MTC14

X = C for open collector
and X = S for 2.5V

Physical Dimensions inches (millimeters) unless otherwise noted

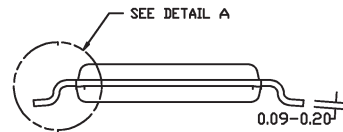
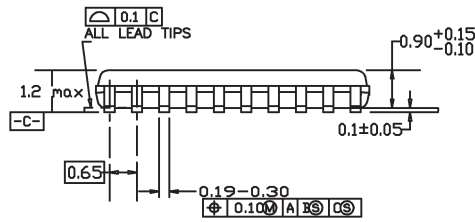
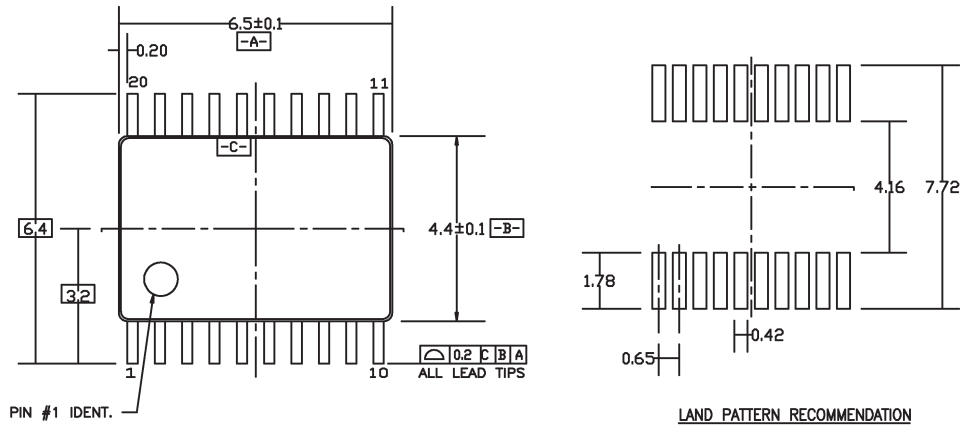

DIMENSIONS ARE IN MILLIMETERS

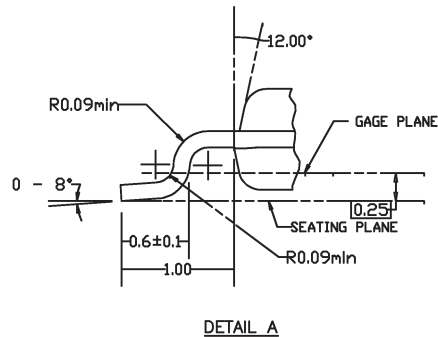

NOTES:

- A. CONFORMS TO JEDEC REGISTRATION MO-153, VARIATION AC, REF NOTE 6, DATE 7/93.
- B. DIMENSIONS ARE IN MILLIMETERS.
- C. DIMENSIONS ARE EXCLUSIVE OF BURRS, MOLDS FLASH, AND TIE BAR EXTRUSIONS.
- D. DIMENSIONS AND TOLERANCES PER ANSI Y14.5M, 1982.

**Order Number FM3560MT
Package Number MTC20**

Life Support Policy

Fairchild's products are not authorized for use as critical components in life support devices or systems without the express written approval of the President of Fairchild Semiconductor Corporation. As used herein:

1. Life support devices or systems are devices or systems which, (a) are intended for surgical implant into the body, or (b) support or sustain life, and whose failure to perform, when properly used in accordance with instructions for use provided in the labeling, can be reasonably expected to result in a significant injury to the user.
2. A critical component is any component of a life support device or system whose failure to perform can be reasonably expected to cause the failure of the life support device or system, or to affect its safety or effectiveness.

Fairchild Semiconductor
Americas
Customer Response Center
Tel. 1-888-522-5372

Fairchild Semiconductor
Europe
Deutsch Tel: +44 (0) 1793-856858
English Tel: +49 (0) 8141-6102-0
Français Tel: +44 (0) 1793-856856
Français Tel: +33 (0) 1-6930-3696
Italiano Tel: +39 (0) 2-249111-1

Fairchild Semiconductor
Hong Kong
8/F, Room 808, Empire Centre
68 Mody Road, Tsimshatsui East
Kowloon, Hong Kong
Tel: +852-2722-8338
Fax: +852-2722-8383

Fairchild Semiconductor
Japan Ltd.
4F, Natsume Bldg.
2-18-6, Yushima, Bunkyo-ku
Tokyo, 113-0034 Japan
Tel: 81-3-3818-8840
Fax: 81-3-3818-8841

find products

Home >> Find products >>

Products groups

Analog and Mixed

Signal

Discrete

Interface

Logic

Microcontrollers

Non-Volatile

Memory

Optoelectronics

Markets and

applications

New products

Product selection and
parametric search

Cross-reference
search

FM3560

4/5-Bit Multiplexed 1-Bit Latched Port with
Standard 2-Wire Bus Interface & Non-Volatile
Latches

Contents

[General description](#) | [Features](#) | [Product
status/pricing/packaging](#)

General description

The FM3540/60 multiplexes the I-port input signals with two internal non-volatile registers that can be loaded through the serial port. The multiplexer is selected via the serial port and defaults to the I-Port upon power-up. Pull-up resistors are provided on the input port to accommodate connections to open drain outputs and to eliminate the need for external resistors. The device supports a choice of either 2.5V output or Open Drain Outputs for easy interface to devices with different VDD Levels.

The serial port is an IIC compatible slave only interface and supports both 100kbits and 400kbits modes of operation. The port is used to read the I-Port, Write Data to the internal non-volatile registers and select whether the I-Port or one of the internal non-volatile registers is output to the Y-port. The FM3540/50/60 is fabricated with an advanced CMOS technology to achieve high density and low power.

[back to top](#)

Features

Related Links

[Request samples](#)

[Dotted line](#)

[How to order products](#)

[Dotted line](#)

[Product Change Notices](#)

[\(PCNs\)](#)

[Dotted line](#)

[Support](#)

[Dotted line](#)

[Distributor and field sales](#)

[representatives](#)

[Dotted line](#)

[Quality and reliability](#)

[Dotted line](#)

[Design tools](#)

Datasheet

[Download this
datasheet](#)

PDF

[e-mail this datasheet](#)

[E-]

This page [Print version](#)

technical information

buy products

technical support

my Fairchild

company

- Extended Operating Voltage Range
3.0V-5.5V
- IIC Compatible Slave Interface.
- ESD performance: Human body model
> 2000V
- Choice of 2.5V outputs or Open-Drain
Outputs

[back to top](#)

Product status/pricing/packaging

Product	Product status	Pricing*	Package type	Leads	Package marking	Packing method
FM3560M20	Full Production	\$0.94	SOIC-Wide	20	\$Y&Z&2&T 3560 M20	RAIL
FM3560M20X	Full Production	\$0.94	SOIC-Wide	20	\$Y&Z&2&T 3560 6 M20	TAPE REEL
FM3560MT20	Full Production	\$0.94	TSSOP	20	\$Y&Z&2&T 3560 6 MT20	RAIL
FM3560MT20X	Full Production	\$0.94	TSSOP	20	\$Y&Z&2&T 3560 6 MT20	TAPE REEL

* 1,000 piece Budgetary Pricing

[back to top](#)

[Home](#) | [Find products](#) | [Technical information](#) | [Buy products](#) |
[Support](#) | [Company](#) | [Contact us](#) | [Site index](#) | [Privacy policy](#)

© Copyright 2002 Fairchild Semiconductor

find products

Home >> Find products >>

Products groups

Analog and Mixed

Signal

Discrete

Interface

Logic

Microcontrollers

Non-Volatile

Memory

Optoelectronics

Markets and

applications

New products

Product selection and

parametric search

Cross-reference

search

technical information

buy products

technical support

my Fairchild

company

FM3540C

4/5-Bit Multiplexed 1-Bit Latched Port with Standard 2-Wire Bus Interface & Non-Volatile Latches

Contents

General description | Features | Product status/pricing/packageing

General description

The FM3540/60 multiplexes the I-port input signals with two internal non-volatile registers that can be loaded through the serial port. The multiplexer is selected via the serial port and defaults to the I-Port upon power-up. Pull-up resistors are provided on the input port to accommodate connections to open drain outputs and to eliminate the need for external resistors. The device supports a choice of either 2.5V output or Open Drain Outputs for easy interface to devices with different VDD Levels.

The serial port is an IIC compatible slave only interface and supports both 100kbits and 400kbits modes of operation. The port is used to read the I-Port, Write Data to the internal non-volatile registers and select whether the I-Port or one of the internal non-volatile registers is output to the Y-port. The FM3540/50/60 is fabricated with an advanced CMOS technology to achieve high density and low power.

back to top

Features

Related Links

Request samples

Dotted line

How to order products

Dotted line

Product Change Notices

(PCNs)

Dotted line

Support

Dotted line

Distributor and field sales

representatives

Dotted line

Quality and reliability

Dotted line

Design tools

Datasheet

Download this datasheet



e-mail this datasheet



This page Print version

- Extended Operating Voltage Range
3.0V-5.5V
- IIC Compatible Slave Interface.
- ESD performance: Human body model
> 2000V
- Choice of 2.5V outputs or Open-Drain
Outputs

[back to top](#)

Product status/pricing/packaging

Product	Product status	Pricing*	Package type	Leads	Package marking	Packing method
FM3540CMT14X	Lifetime Buy	\$1.00	TSSOP	14	&2&T \$Y40 &Z3540 C	TAPE REEL
FM3540CM14	Lifetime Buy	\$0.94	SOIC	14	\$Y&Z&2&T 3540C 6	RAIL
FM3540CMT14	Lifetime Buy	\$0.99	TSSOP	14	&2&T \$Y40 &Z3540 C	RAIL
FM3540CM14X	Lifetime Buy	\$0.94	SOIC	14	\$Y&Z&2&T 3540C 6	TAPE REEL

* 1,000 piece Budgetary Pricing

[back to top](#)

[Home](#) | [Find products](#) | [Technical information](#) | [Buy products](#) |
[Support](#) | [Company](#) | [Contact us](#) | [Site index](#) | [Privacy policy](#)

© Copyright 2002 Fairchild Semiconductor