

# SMT Power Inductors

Power Beads - PG2110.XXXHLT Series

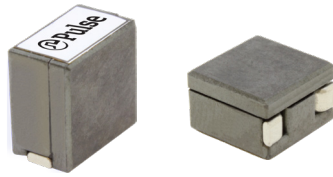

- Ⓢ **Current Rating:** Over 75A<sub>pk</sub>
- Ⓢ **Inductance Range:** 100nH to 180nH
- Ⓢ **Height:** 8mm Max
- Ⓢ **Footprint:** 8mm x 5mm Max

## Electrical Specifications @ 25°C — Operating Temperature - 40°C to +130°C<sup>7</sup>

Part Number	Inductance <sup>1</sup> @ 0A <sub>DC</sub> (nH +/- 15%)	Inductance <sup>2</sup> @ I <sub>rated</sub> <sup>3</sup> (nH TYP)	I <sub>rated</sub> <sup>3</sup> (ADC)	DCR <sup>4</sup> (mΩ ± 10%)	Saturation Current <sup>5</sup> (A TYP)		Heating Current <sup>6</sup> (A TYP)
					25°C	100°C	
PG2110.101HLT	100		53	0.22	75	60	53
PG2110.121HLT	120		53		61	49	
PG2110.151HLT	150	105	50		50	40	
PG2110.181HLT	180	126	41		41	32	

**NOTES:**

- Inductance measured at 100kHz, 100mVrms.
- Inductance at I<sub>rated</sub> is the value of the inductance at 25°C at the listed rated current.
- The rated current as listed is either the saturation current (25°C or 100°C) or the heating current depending on which value is lower.
- The nominal DCR is measured at point  $\triangle 2$ , as shown below on the mechanical drawing.
- The saturation current is the typical current which causes the inductance to drop by 20% at the stated ambient temperatures (25°C, 100°C). This current is determined by placing the component in the specified ambient environment and applying a short duration pulse current (to eliminate self-heating effects) to the component.
- The heating current is the DC current which causes the part temperature to increase by approximately 40°C when used in a typical application.
- In high volt\*time applications, additional heating in the component can occur due to core losses in the inductor which may necessitate derating the current in order to limit the temperature rise of the component. To determine the approximate total losses (or temperature rise) for a given application, the coreloss and temperature rise curves can be used.
- Parts with the HLT suffix are sold in tape and reel packaging. Pulse complies to industry standard tape and reel specification EIA-481. The tape and reel for this product has a width (W=24mm), pitch (Po=12mm) and depth (Ko=8.1mm). Samples of these parts can be ordered by removing the HLT suffix and replacing with HL.
- The temperature of the component (ambient plus temperature rise) must be within the stated operating temperature range.

### Mechanical

### Schematic

#### PG2110.XXXHLT

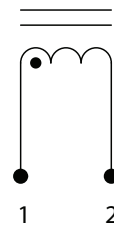
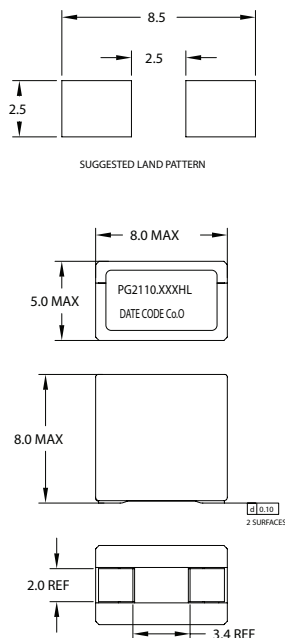

**Weight:** 2.74grms

**Tape & Reel:** 500/Reel

**Dimensions:** mm

Unless otherwise specified, all tolerances are ± 0.25

## TAPE & REEL INFO

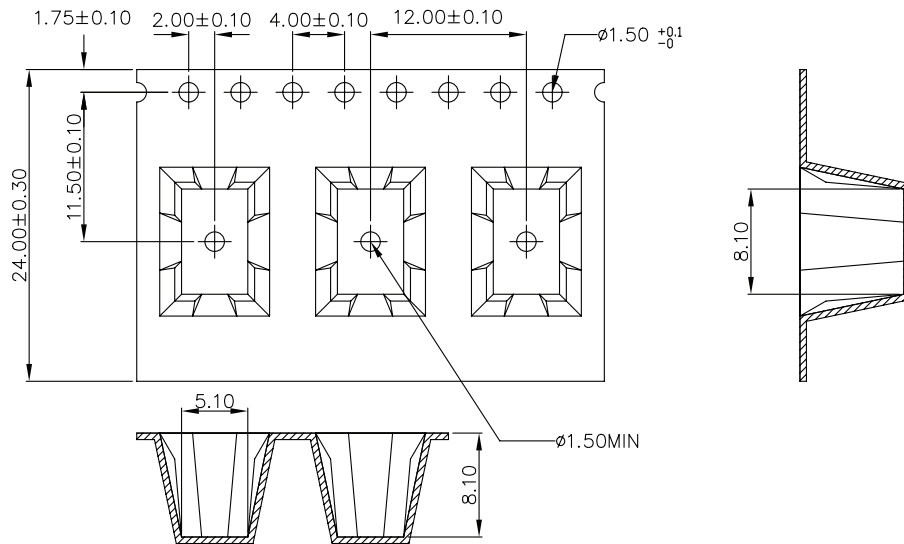

### SURFACE MOUNTING TYPE, REEL/TAPE LIST

TYPE	REEL SIZE (mm)			TAPE SIZE (mm)	QTY
	W ± 0.30	A0 ± 0.1	B0 ± 0.1	K0 ± 0.1	PCS/REEL
PG2110.XXXHLT	24.0	5.1	8.1	8.1	500

**PG2110.XXXHLT, L vs I, Curve 25C**

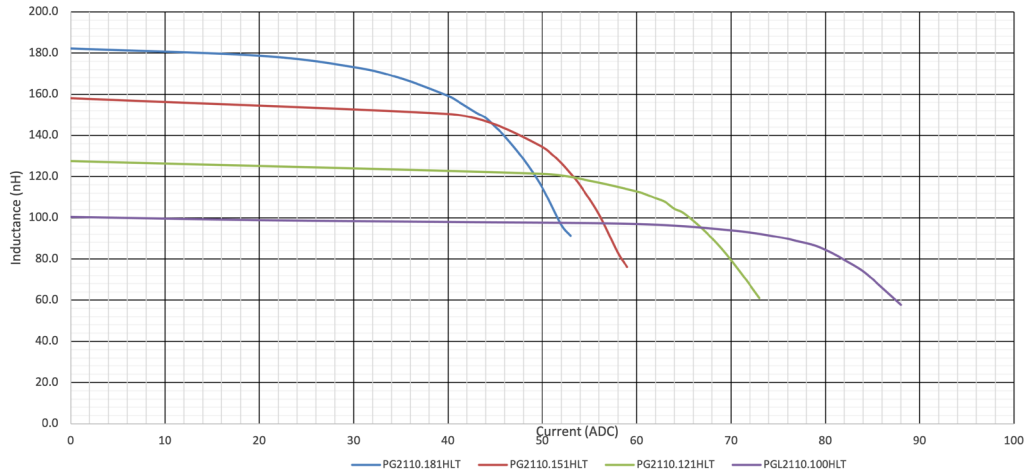

**PG2110.XXXHLT, L vs I, Curve 100C**

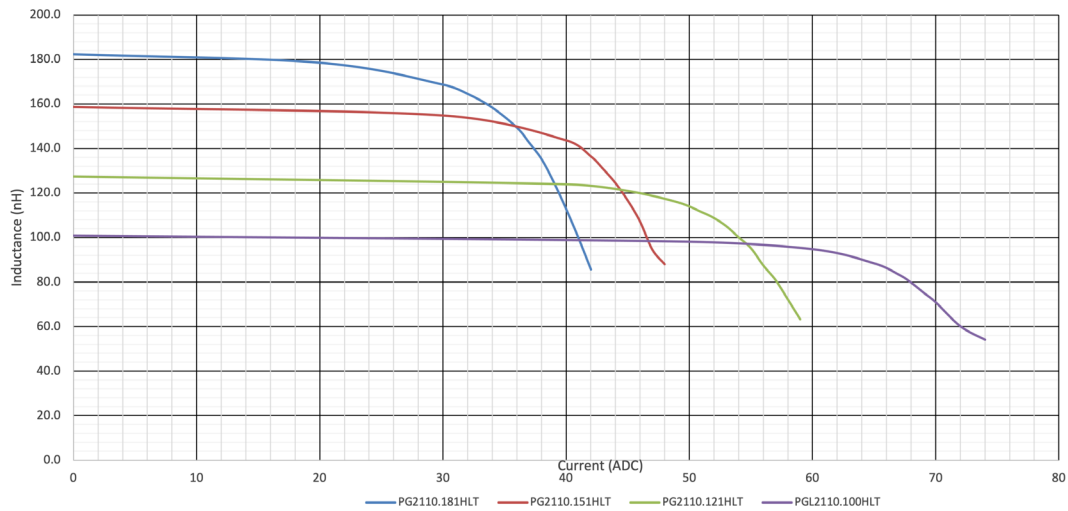

# SMT Power Inductors

Power Beads - PG2110.XXXHLT Series

## PG2110.XXHLT CoreLoss (W)

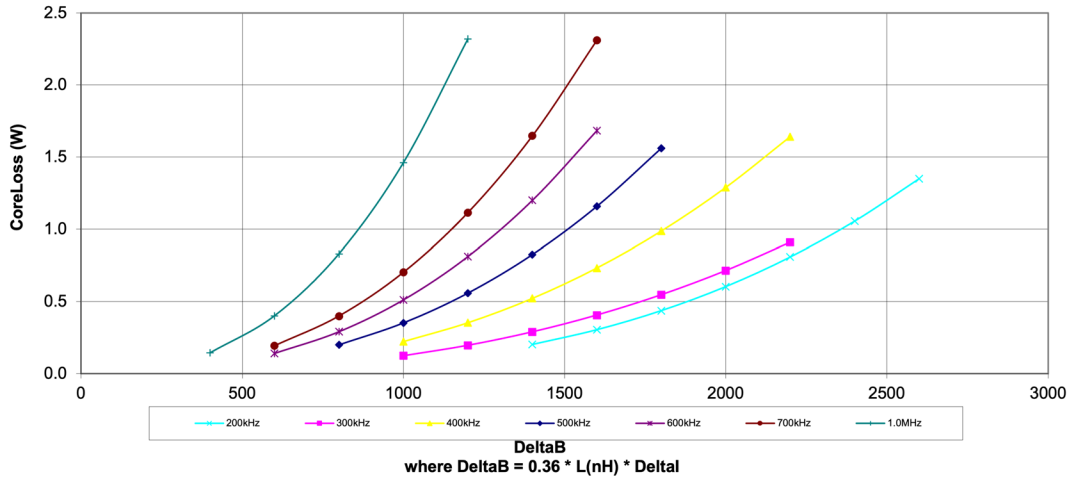

## PG2110.XXXHLT Temp Rise vs Power Dissipation

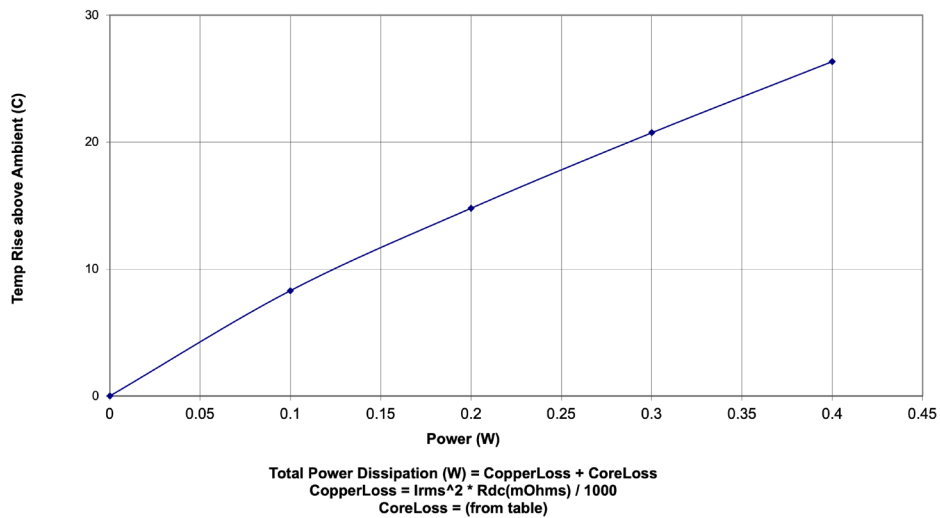

### For More Information:

Americas - [prodinfo\\_power@pulseelectronics.com](mailto:prodinfo_power@pulseelectronics.com) | Europe - [power-apps-europe@pulseelectronics.com](mailto:power-apps-europe@pulseelectronics.com) | Asia - [power-apps-asia@pulseelectronics.com](mailto:power-apps-asia@pulseelectronics.com)

Performance warranty of products offered on this data sheet is limited to the parameters specified. Data is subject to change without notice. Other brand and product names mentioned herein may be trademarks or registered trademarks of their respective owners. © Copyright, 2021. Pulse Electronics, Inc. All rights reserved.