

SDCH1V50

Semi-shielded power inductors



Product features

- High current carrying capacity
- High power density, low core losses
- Magnetically semi-shielded
- 5.2 mm x 5.2 mm surface mount package in 2.0 mm and 4.1 mm heights
- NiZn ferrite magnetic material
- Moisture sensitivity level (MSL): 1

Applications

- DC-DC converters
- Switching controllers
- Industrial IoT equipment
- Game consoles
- Portable electronics
- Laptops, notebooks, and netbooks
- Desktops and workstations
- Battery backup
- LED lighting
- HD televisions and displays

Environmental compliance and general specifications

- Storage temperature range (component): -40 °C to +125 °C
- Operating temperature range: -40 °C to +125 °C (ambient plus self-temperature rise)
- Solder reflow temperature: J-STD-020 (latest revision) compliant



Product specifications

Part number ⁵	OCL ¹ (μ H)	FLL ² (μ H) minimum	I_{rms}^3 (A)	I_{sat}^4 (A)	DCR (m Ω) @ +20 °C nominal	DCR (m Ω) @ +20 °C maximum
SDCH1V5020						
SDCH1V5020-1R0N-R	1.0 \pm 30%	0.46	4.2	4.33	23	26
SDCH1V5020-1R5N-R	1.5 \pm 30%	0.68	3.6	4.2	27	31
SDCH1V5020-2R2M-R	2.2 \pm 20%	1.14	3.0	3.8	39	45
SDCH1V5020-3R3M-R	3.3 \pm 20%	1.72	2.5	3.2	50	58
SDCH1V5020-4R7M-R	4.7 \pm 20%	2.44	2.2	2.6	68	78
SDCH1V5020-6R8M-R	6.8 \pm 20%	3.54	1.9	2.2	85	98
SDCH1V5020-100M-R	10 \pm 20%	5.2	1.5	1.6	124	143
SDCH1V5020-150M-R	15 \pm 20%	7.8	1.3	1.5	180	207
SDCH1V5020-220M-R	22 \pm 20%	11.44	1.05	1.15	280	322
SDCH1V5020-330M-R	33 \pm 20%	17.16	0.9	1.0	390	449
SDCH1V5020-470M-R	47 \pm 20%	24.44	0.75	0.82	530	610
SDCH1V5020-680M-R	68 \pm 20%	35.36	0.55	0.59	630	725
SDCH1V5020-101M-R	100 \pm 20%	52.0	0.5	0.55	1110	1277
SDCH1V5020-221M-R	220 \pm 20%	114.4	0.3	0.36	2400	2760
SDCH1V5020-331M-R	330 \pm 20%	171.6	0.25	0.27	3200	3680
SDCH1V5020-471M-R	470 \pm 20%	244.4	0.21	0.26	6400	7360
SDCH1V5020-681M-R	680 \pm 20%	353.6	0.16	0.2	9800	11270
SDCH1V5040						
SDCH1V5040-1R0N-R	1.0 \pm 30%	0.46	4.7	8.0	14	18
SDCH1V5040-1R5N-R	1.5 \pm 30%	0.68	4.5	5.3	20	24
SDCH1V5040-2R2M-R	2.2 \pm 20%	1.14	4.2	4.9	22	25
SDCH1V5040-3R3M-R	3.3 \pm 20%	1.72	4.0	4.2	28	32
SDCH1V5040-4R7M-R	4.7 \pm 20%	2.44	3.1	3.5	34	39
SDCH1V5040-6R8M-R	6.8 \pm 20%	3.54	2.8	2.9	46	53
SDCH1V5040-100M-R	10 \pm 20%	5.2	2.2	2.3	63	72
SDCH1V5040-150M-R	15 \pm 20%	7.8	1.8	2	95	109
SDCH1V5040-220M-R	22 \pm 20%	11.44	1.4	1.6	140	161
SDCH1V5040-330M-R	33 \pm 20%	17.16	1.2	1.3	190	219
SDCH1V5040-470M-R	47 \pm 20%	24.44	1.0	1.1	310	357
SDCH1V5040-680M-R	68 \pm 20%	35.36	0.75	0.85	440	506
SDCH1V5040-101M-R	100 \pm 20%	52.0	0.65	0.75	550	633
SDCH1V5040-221M-R	220 \pm 20%	114.4	0.42	0.48	1750	2013
SDCH1V5040-331M-R	330 \pm 20%	171.6	0.35	0.4	2200	2530
SDCH1V5040-471M-R	470 \pm 20%	244.4	0.3	0.33	2750	3163
SDCH1V5040-681M-R	680 \pm 20%	353.6	0.23	0.28	4850	5578

1. Open circuit inductance (OCL) test parameters: 100 kHz, 0.25 Vrms, 0.0 Adc, +25 °C

2. Full load inductance (FLL) test parameters: 100 kHz, 0.25 Vrms, I_{sat} , +25 °C

3. I_{max} : DC current for an approximate temperature rise of 40 °C without core loss. Derating is necessary for AC currents. PCB layout, trace thickness and width, air-flow, and proximity of other heat generating components will affect the temperature rise. It is recommended that the temperature of the part not exceed +125 °C under worst case operating conditions verified in the end application.

4. I_{sat} : Peak current for approximately 35% maximum rolloff @ +25 °C

5. Part number definition: SDCH1Vxxx-yyyz-R

SDCH1V = Product code

xxx= size code

yyy= Inductance value in μ H, R=decimal point

z= Inductance tolerance

-R suffix = RoHS compliant

Dimensions-mm

SDCH1V5020

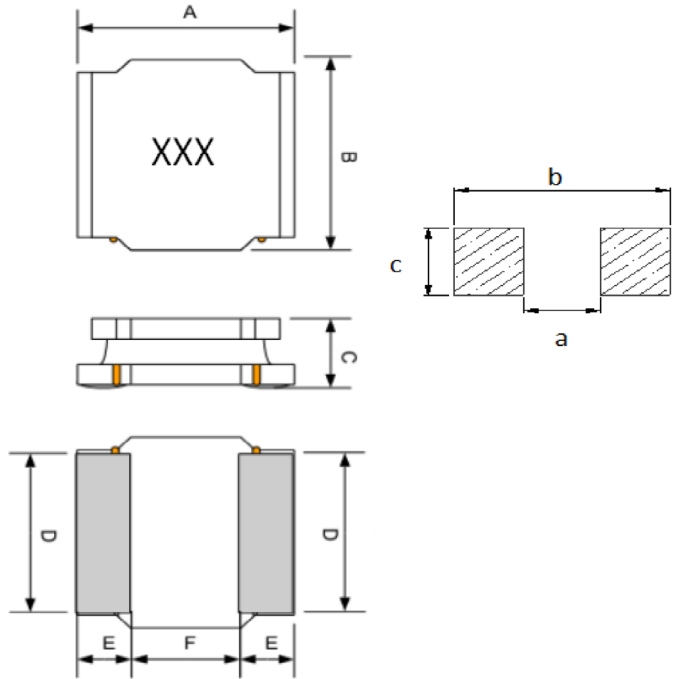

Dimension	Value
A	5.0 ± 0.2
B	5.0 ± 0.2
C	2.0 MAX
D	4.0 ± 0.2
E	1.35 ± 0.3
F	2.3 ± 0.3
a	2.0 TYP
b	5.3 TYP
c	4.3 TYP

SDCH1V5040

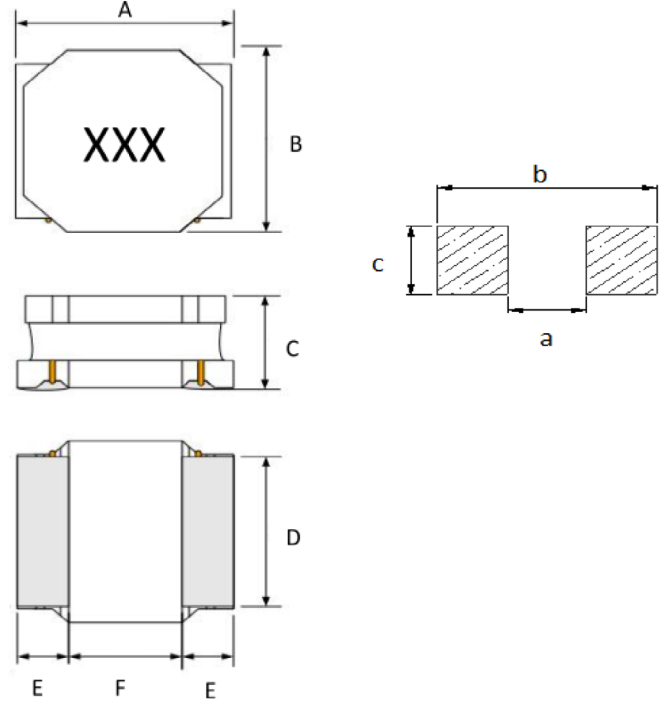

Dimension	Value
A	5.0 ± 0.2
B	5.0 ± 0.2
C	4.1 MAX
D	4.0 ± 0.2
E	1.5 ± 0.3
F	2.0 ± 0.3
a	1.7 TYP
b	5.3 TYP
c	4.3 TYP

Part marking: xxx= inductance value in uH, R= decimal point. If no R is present then last character equals number of zeros.

Tolerances are ±0.3 millimeters unless stated otherwise

All soldering surfaces to be coplanar within 0.1 millimeters

Pad layout tolerances are ±0.1 millimeters unless stated otherwise

Traces or vias underneath the inductor is not recommended

Packaging information- mm

SDCH1V5020

Supplied in tape and reel packaging, 2500 parts per 13" diameter reel (EIA-481 compliant)
Drawing not to scale

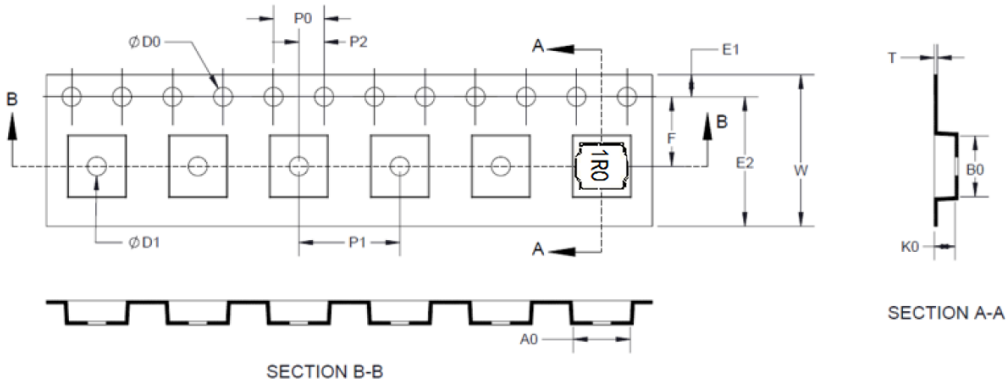

Dimension	Value
W	12.00 ± 0.30
F	5.50 ± 0.10
E1	1.75 ± 0.10
E2	N/A
P0	4.00 ± 0.10
P1	8.00 ± 0.10
P2	2.00 ± 0.10
ØD0	1.50 + 0.10/-0
ØD1	N/A
A0	5.3 ± 0.1
B0	5.3 ± 0.1
K0	2.3 ± 0.1
T	0.35 ± 0.05

Packaging information- mm

SDCH1V5040

Supplied in tape and reel packaging, 1500 parts per 13" diameter reel (EIA-481 compliant)
Drawing not to scale

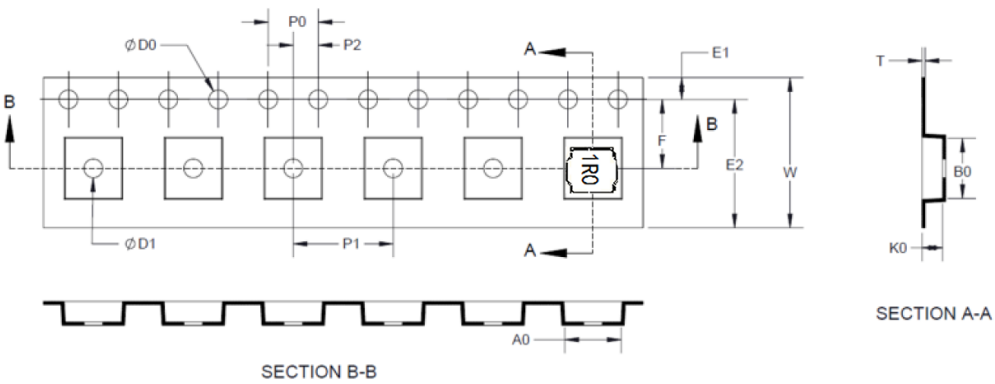

Dimension	Value
W	12.00 ± 0.30
F	5.50 ± 0.10
E1	1.75 ± 0.10
E2	N/A
P0	4.00 ± 0.10
P1	8.00 ± 0.10
P2	2.00 ± 0.10
ØD0	1.50 + 0.10/-0
ØD1	N/A
A0	5.30 ± 0.10
B0	5.30 ± 0.10
K0	4.30 ± 0.10
T	0.40 ± 0.05

Inductance and temperature rise vs current
SDCH1V5020

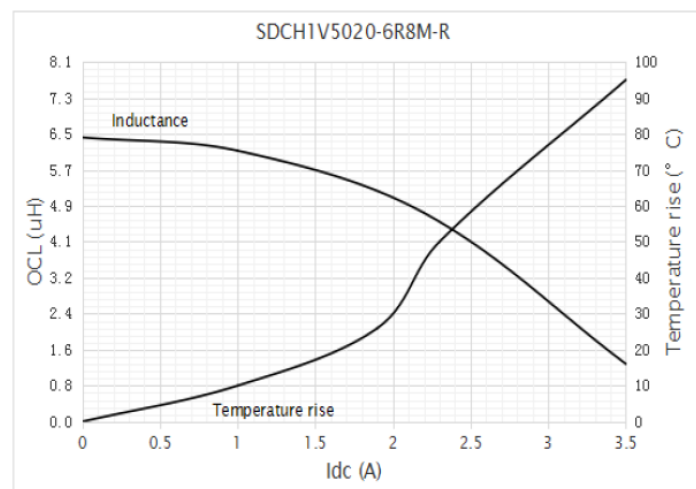
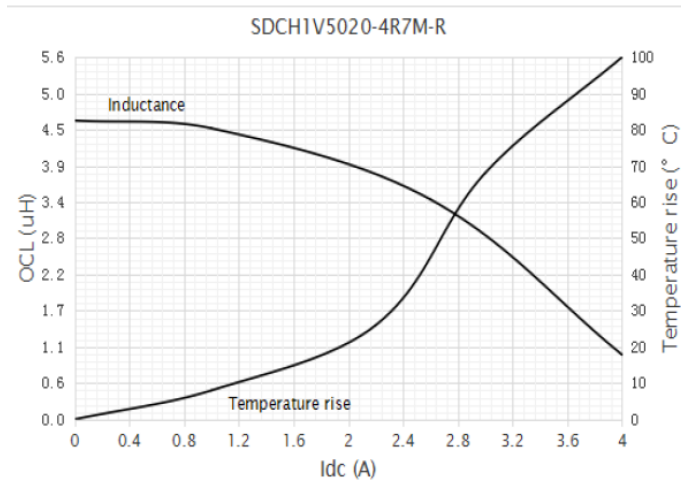
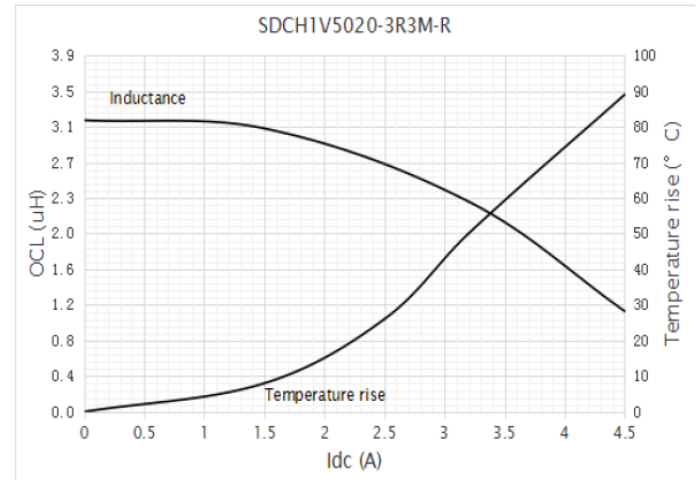
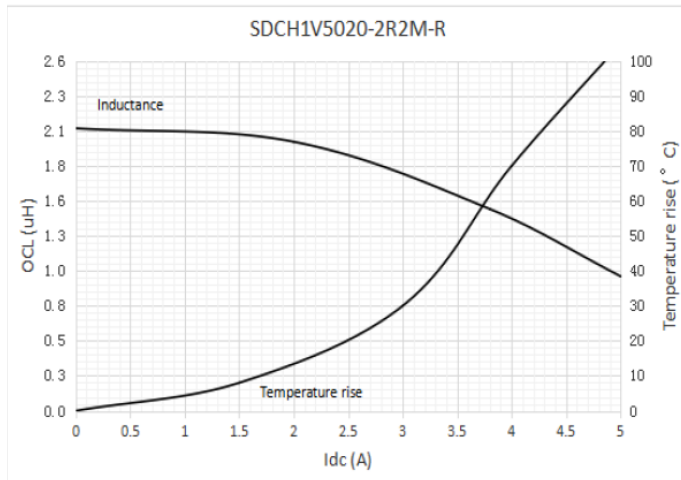
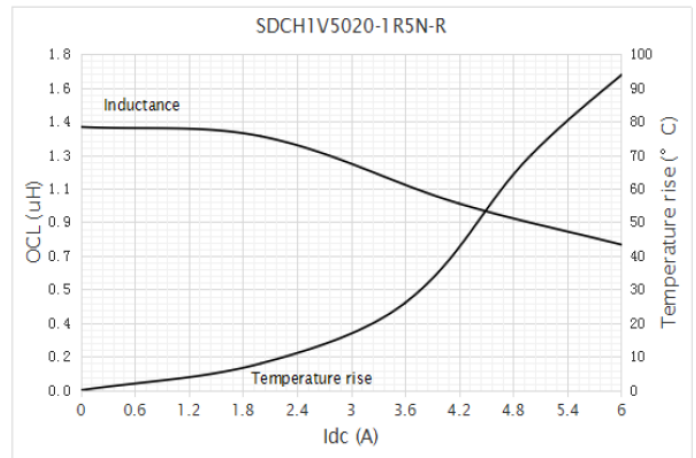
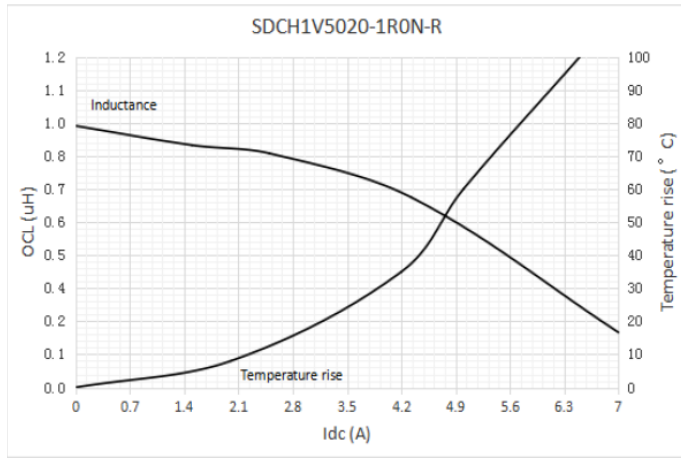

Inductance and temperature rise vs current
SDCH1V5020

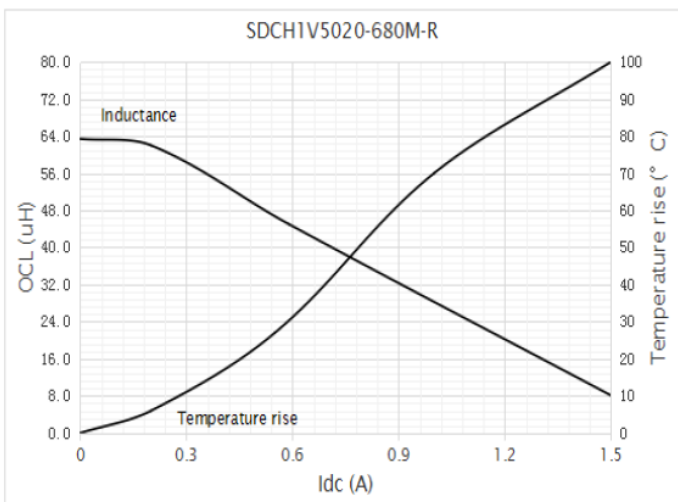
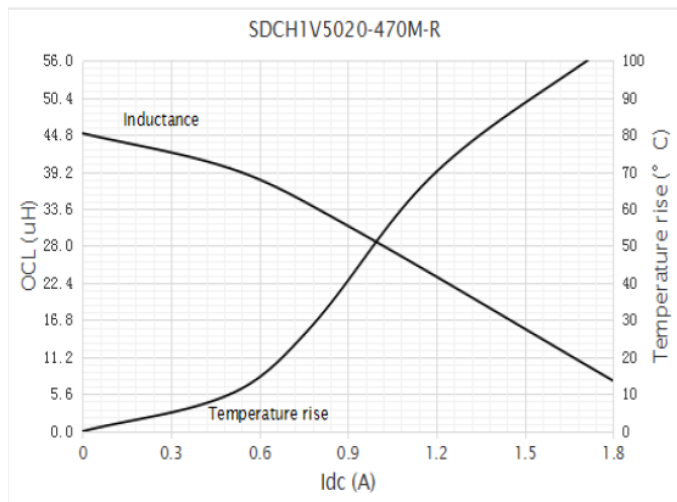
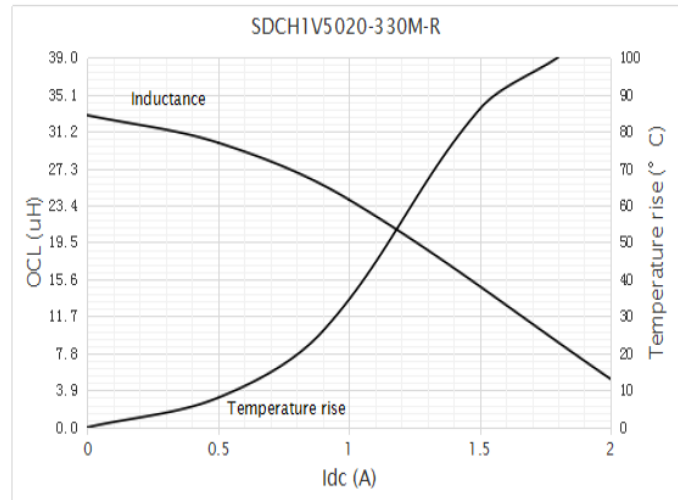
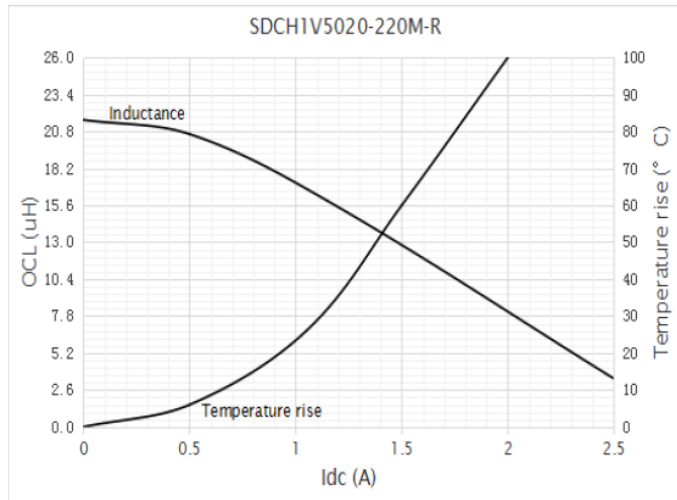
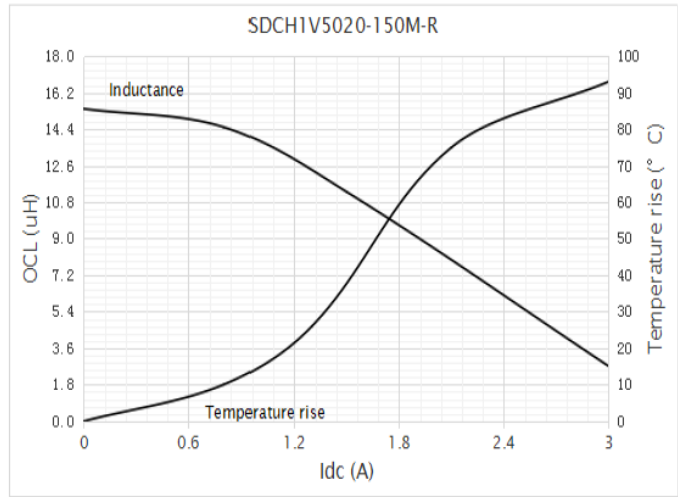
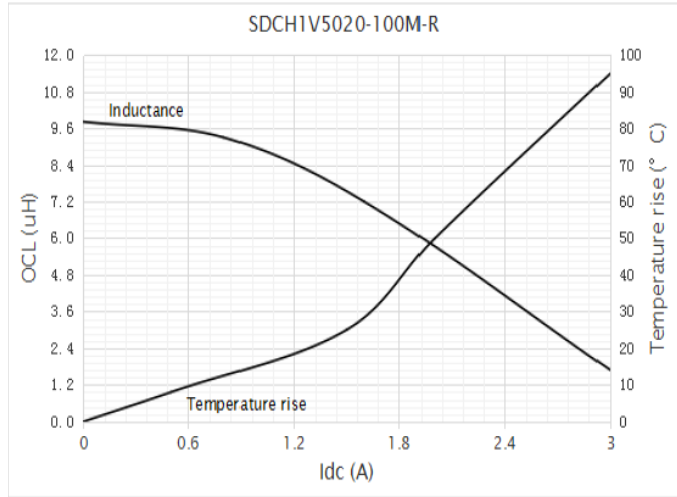

Inductance and temperature rise vs current
SDCH1V5020

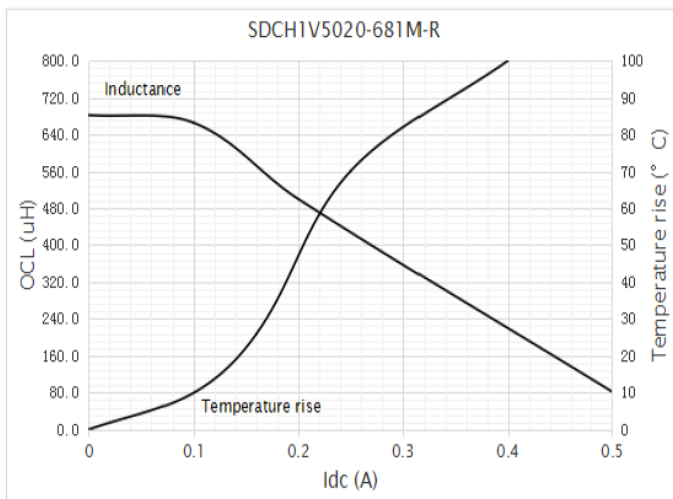
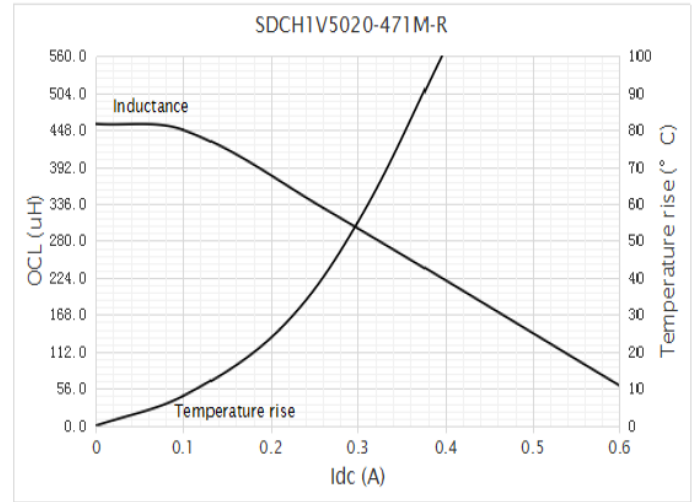
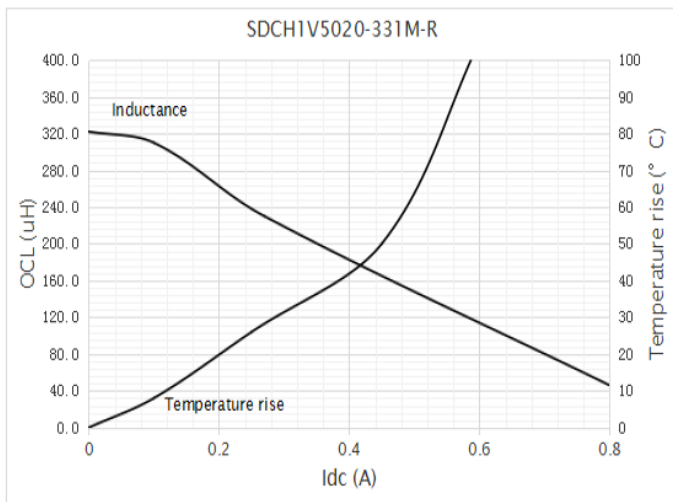
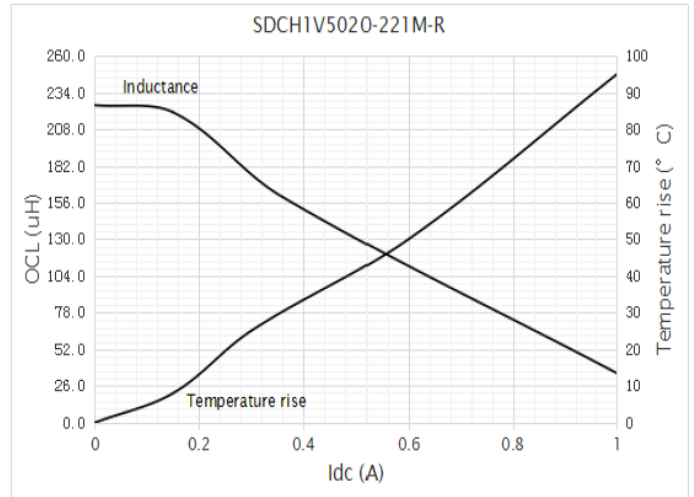
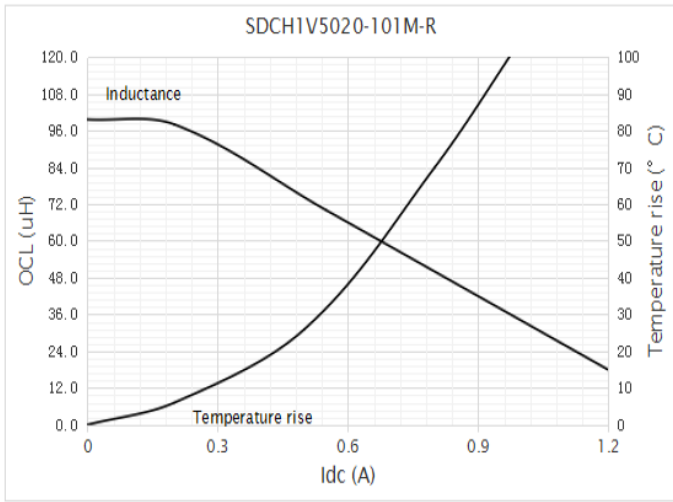

Inductance and temperature rise vs current
SDCH1V5040

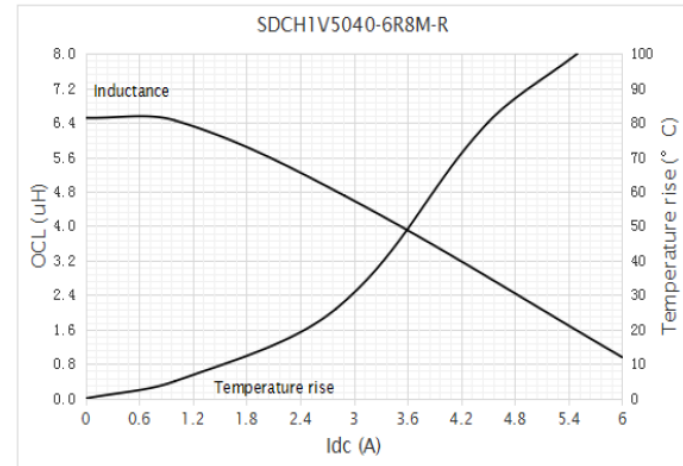
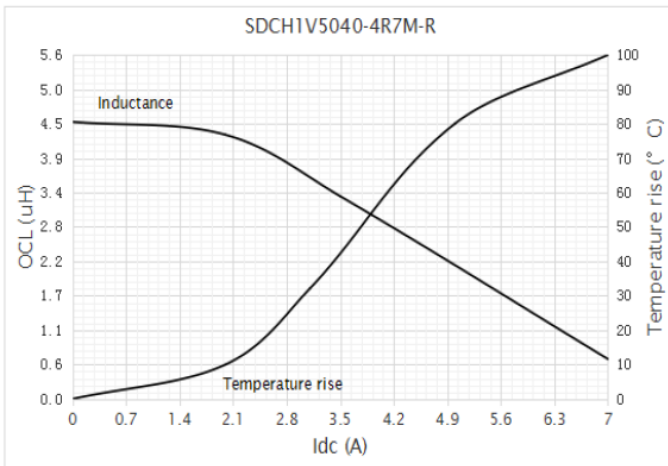
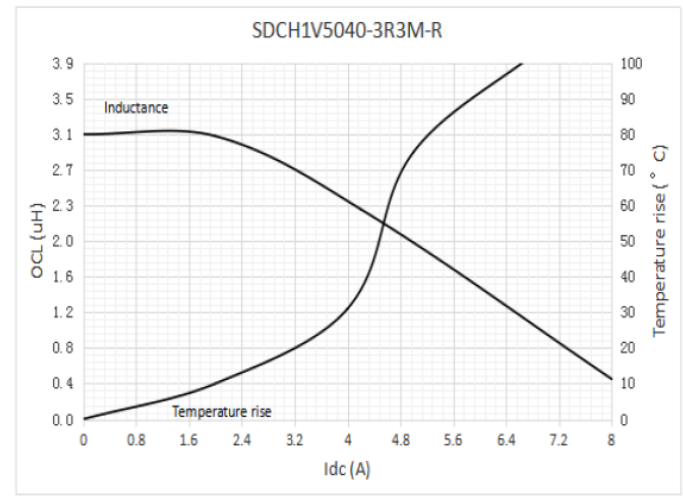
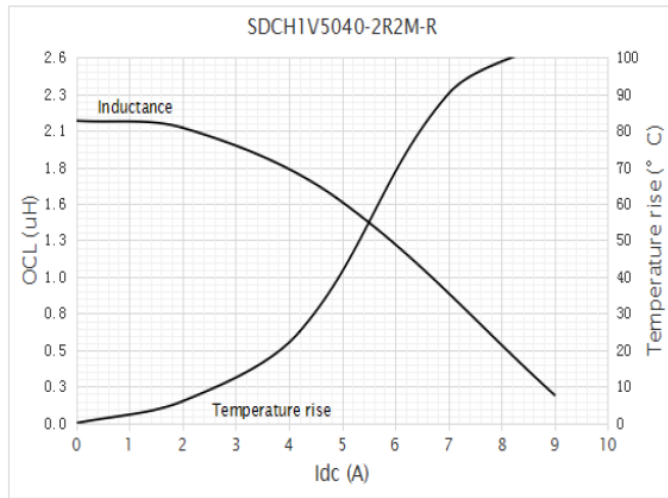
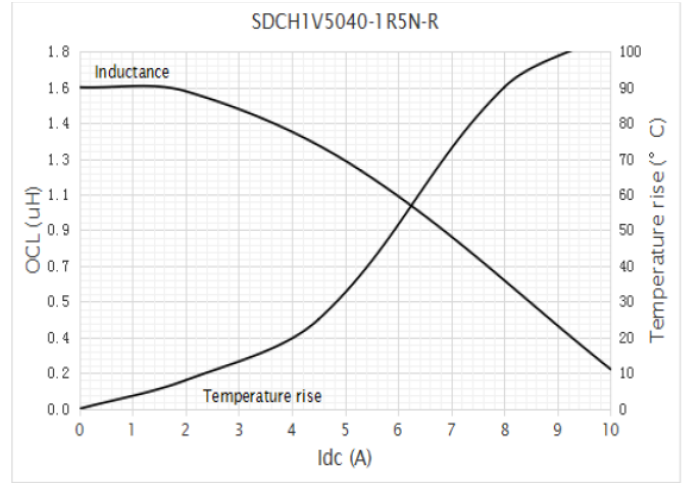
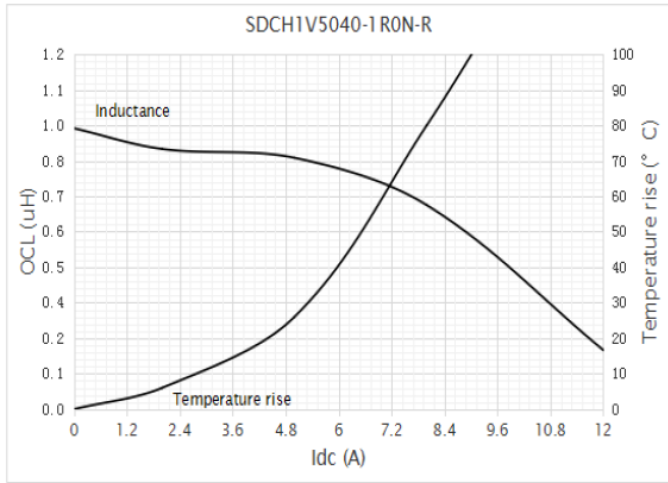

Inductance and temperature rise vs current
SDCH1V5040

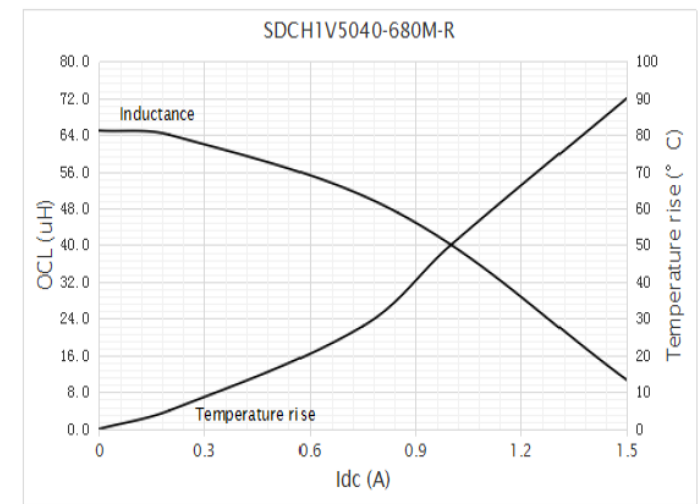
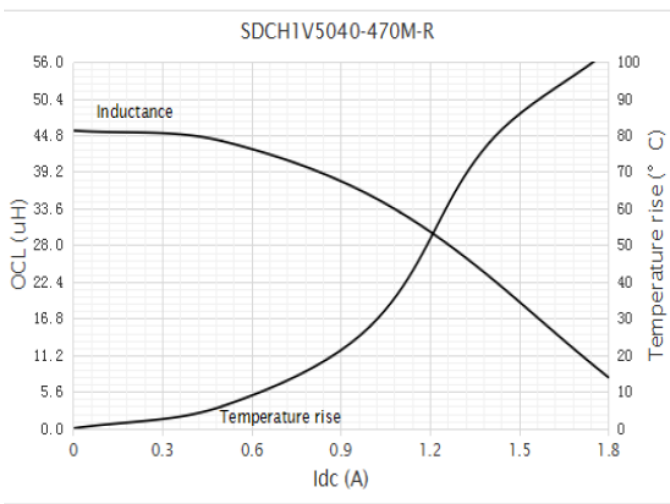
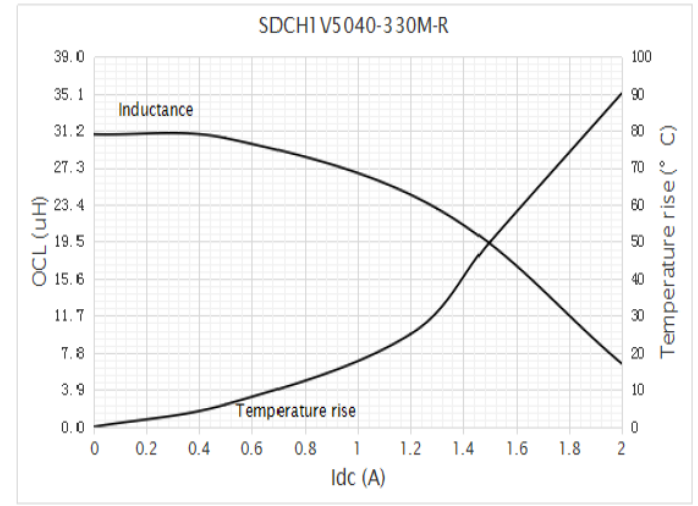
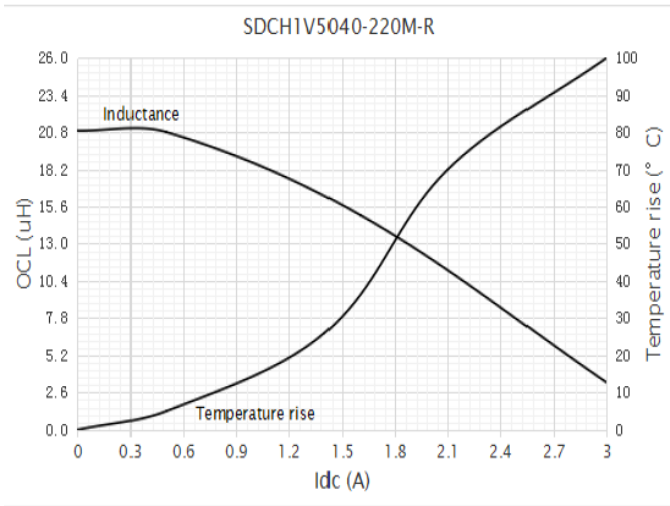
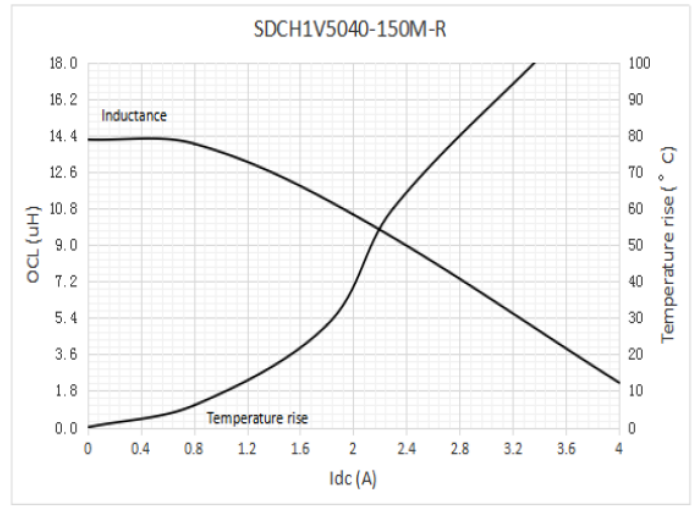
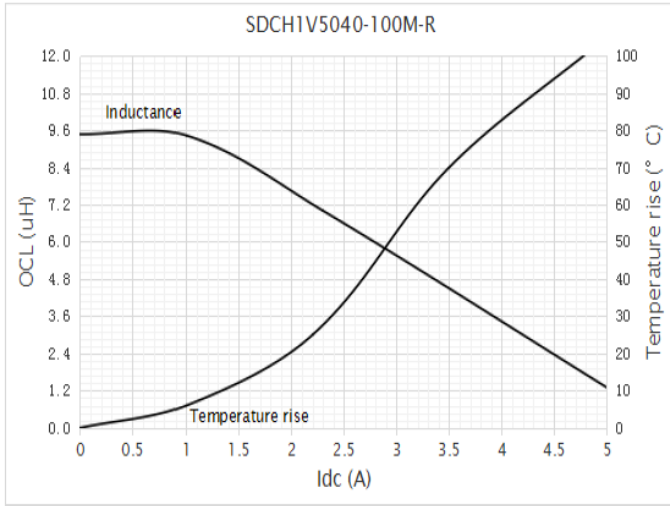

Inductance and temperature rise vs current
SDCH1V5040

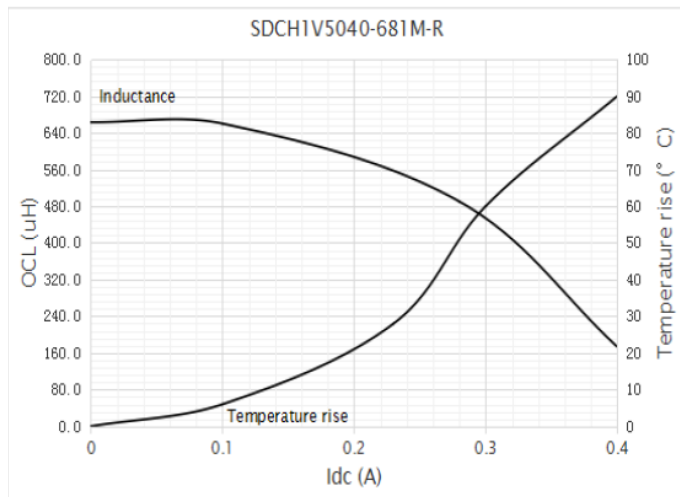
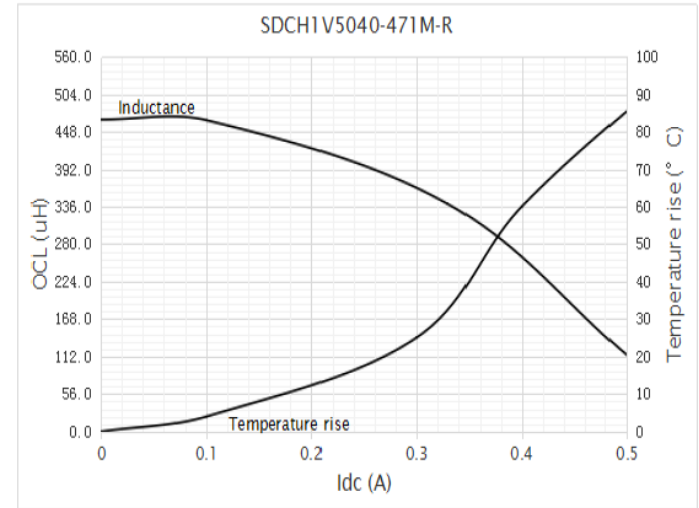
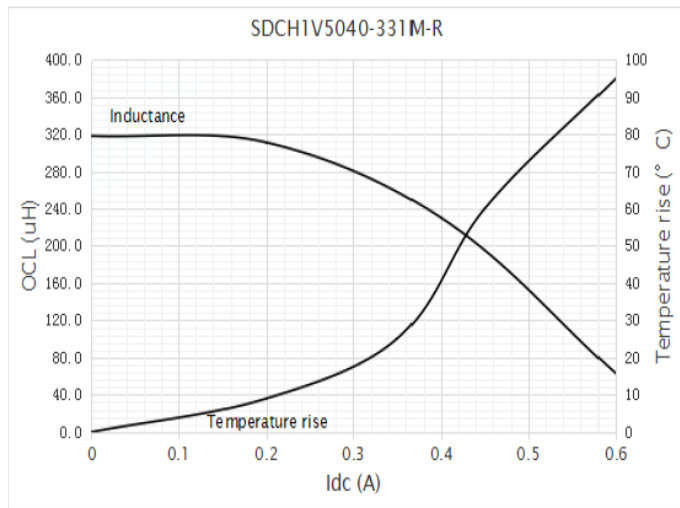
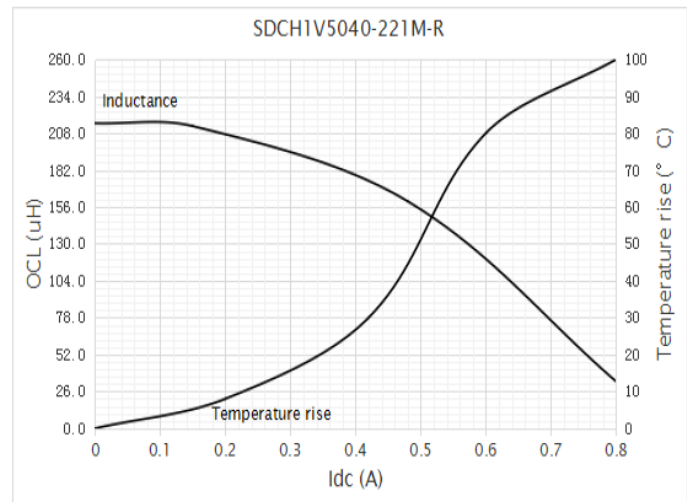
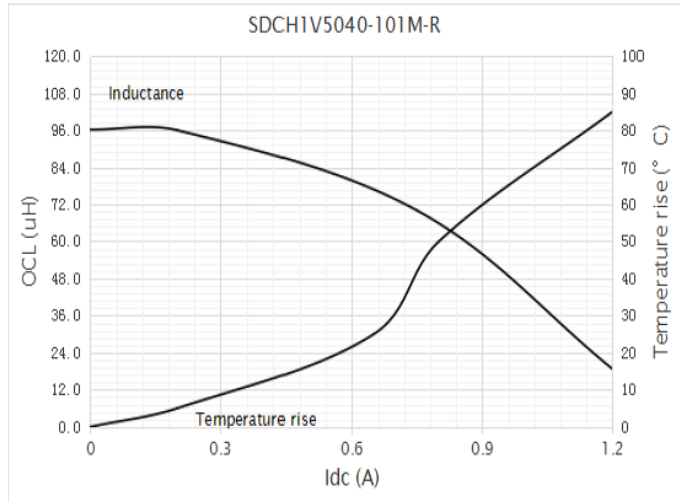

Solder reflow profile

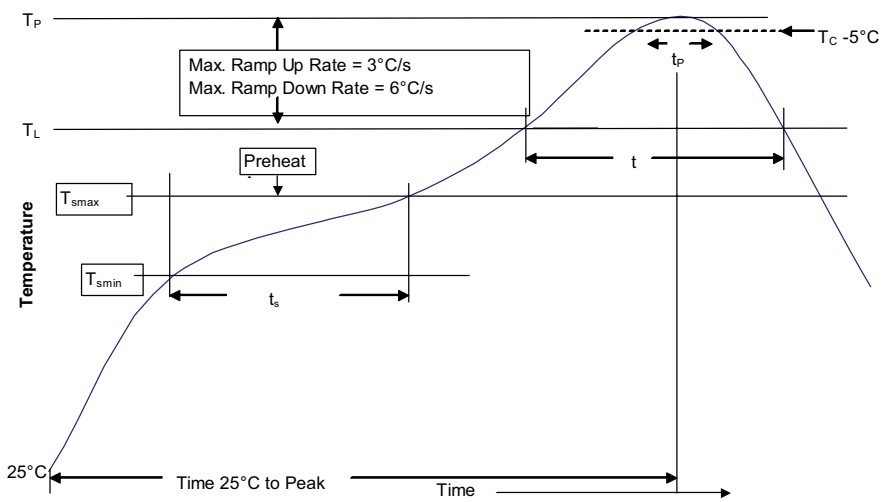

Table 1 - Standard SnPb solder (T_C)

Package thickness	Volume mm ³ <350	Volume mm ³ ≥350
<2.5 mm	235 °C	220 °C
≥2.5 mm	220 °C	220 °C

Table 2 - Lead (Pb) free solder (T_C)

Package thickness	Volume mm ³ <350	Volume mm ³ 350 - 2000	Volume mm ³ >2000
<1.6 mm	260 °C	260 °C	260 °C
1.6 – 2.5 mm	260 °C	250 °C	245 °C
>2.5 mm	250 °C	245 °C	245 °C

Reference J-STD-020

Profile feature	Standard SnPb solder	Lead (Pb) free solder
Preheat and soak		
• Temperature min. (T _{smin})	100 °C	150 °C
• Temperature max. (T _{smax})	150 °C	200 °C
• Time (T _{smin} to T _{smax}) (t _s)	60-120 seconds	60-120 seconds
Ramp up rate T _L to T _p	3 °C/ second max.	3 °C/ second max.
Liquidous temperature (T _L)	183 °C	217 °C
Time (t _L) maintained above T _L	60-150 seconds	60-150 seconds
Peak package body temperature (T _p)*	Table 1	Table 2
Time (t _p)* within 5 °C of the specified classification temperature (T _C)	20 seconds*	30 seconds*
Ramp-down rate (T _p to T _L)	6 °C/ second max.	6 °C/ second max.
Time 25 °C to peak temperature	6 minutes max.	8 minutes max.

* Tolerance for peak profile temperature (T_p) is defined as a supplier minimum and a user maximum.

Life Support Policy: Eaton does not authorize the use of any of its products for use in life support devices or systems without the express written approval of an officer of the Company. Life support systems are devices which support or sustain life, and whose failure to perform, when properly used in accordance with instructions for use provided in the labeling, can be reasonably expected to result in significant injury to the user.

Eaton reserves the right, without notice, to change design or construction of any products and to discontinue or limit distribution of any products. Eaton also reserves the right to change or update, without notice, any technical information contained in this bulletin.

Eaton
Electronics Division
1000 Eaton Boulevard
Cleveland, OH 44122
United States
Eaton.com/electronics

© 2021 Eaton
All Rights Reserved
Printed in USA
Publication No. ELX1033 BU-ELX21033
April 2021

Eaton is a registered trademark.
All other trademarks are property of their respective owners.

Follow us on social media to get the latest product and support information.

