

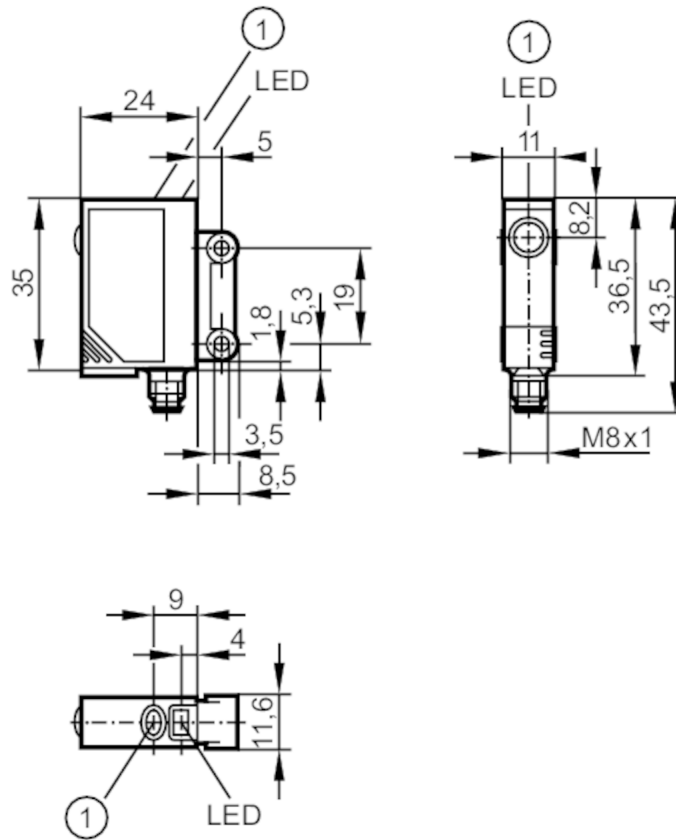

Retro-reflective sensor for the detection of transparent objects

OJPGFPKG/SO/AS



1 pushbutton



Product characteristics

Type of light	red light
Housing	rectangular

Application

Special feature	polarisation filter
Function principle	Retro-reflective sensor

Electrical data

Operating voltage	[V]	10...30 DC
Current consumption	[mA]	< 22
Protection class		III
Reverse polarity protection		yes
Type of light		red light
Wave length	[nm]	660

Outputs

Electrical design		PNP
Output function		light-on/dark-on mode; (programmable)
Max. voltage drop switching output DC	[V]	2.5



Retro-reflective sensor for the detection of transparent objects

OJPGFPKG/SO/AS

Permanent current rating of switching output DC [mA]	200
Switching frequency DC [Hz]	2000
Short-circuit protection	yes
Type of short-circuit protection	pulsed
Overload protection	yes

Detection zone

Range referred to prismatic reflector [m]	0.2...1.5; (Prismatic reflector 50 x 50 mm E20722)
Range adjustable	yes
Max. light spot diameter [mm]	64
Light spot dimensions refer to	at maximum range
Polarisation filter available	yes

Operating conditions

Ambient temperature [°C]	0...60
Protection	IP 67

Tests / approvals

EMC	EN 60947-5-2
MTTF [years]	854

Mechanical data

Weight [g]	27.3
Housing	rectangular
Dimensions [mm]	35 x 11 x 24
Materials	housing: ABS; LED window: SEPS; pushbutton: SEPS
Lens material	glass
Lens alignment	side lens

Displays / operating elements

Display	switching status	1 x LED, yellow
	operation	1 x LED, green
	function	1 x LED, red
Electronic lock	yes	

Accessories

Items supplied	screws: 2
	spring washers: 2
	Nuts: 2

Remarks

Remarks	operating voltage "supply class 2" according to cULus
Pack quantity	1 pcs.

OJ5186



Retro-reflective sensor for the detection of transparent objects

OJPGFPKG/SO/AS

Electrical connection

Connector: 1 x M8; coding: A



Connection

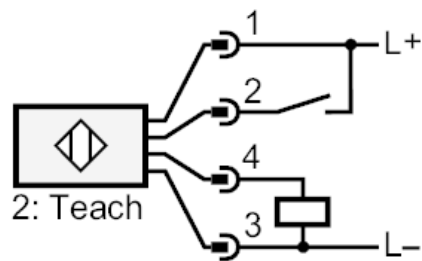

2

Teach



Retro-reflective sensor for the detection of transparent objects

OJPGFPKG/SO/AS

Diagrams and graphs

excess gain graph

