

P	LTR	DESCRIPTION	DATE	DWN	APVD
	B1	REVISED PER ECR-21-100686	10MAR2021	SK	DZ

KEYING A SHOWN FOR 6 POS

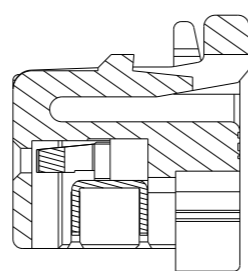

SECTION A-A FOR 2~5P

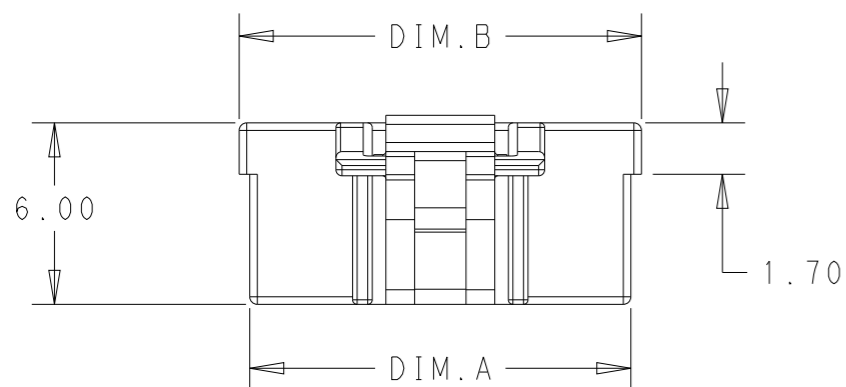
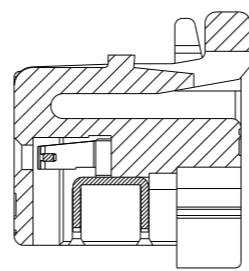

SECTION A-A FOR 6~10P

- 1 MATERIAL:
HOUSING : THERMOPLASTIC, UL94 V0;
REC. CONTACT : PHOS-BRONZE, PRE-TIN .
- 2. PRODUCT COMPLY WITH GLOW WIRE REQUIREMENTS FOR PARTS OF NON-METALLIC MATERIAL SUPPORTING A CURRENT-CARRYING CONNECTION DETAILED IN IEC 60335-1, SECTION 30 (GWT).
- 3. MATING PARTS PLEASE SEE TABLE IN PAGE1 AND PAGE2.
- 4 OBSOLETE.

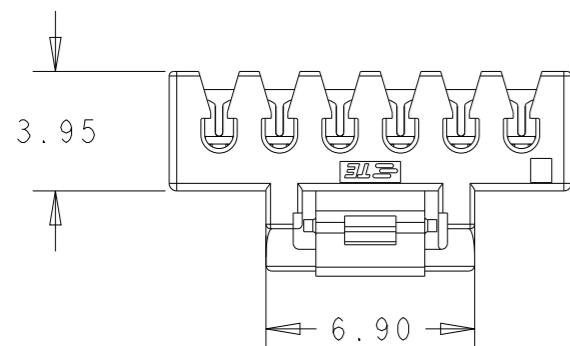
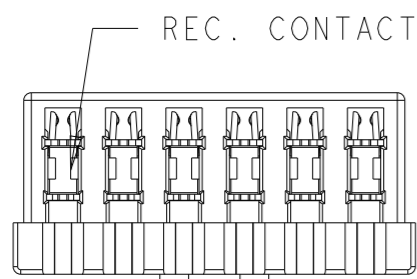
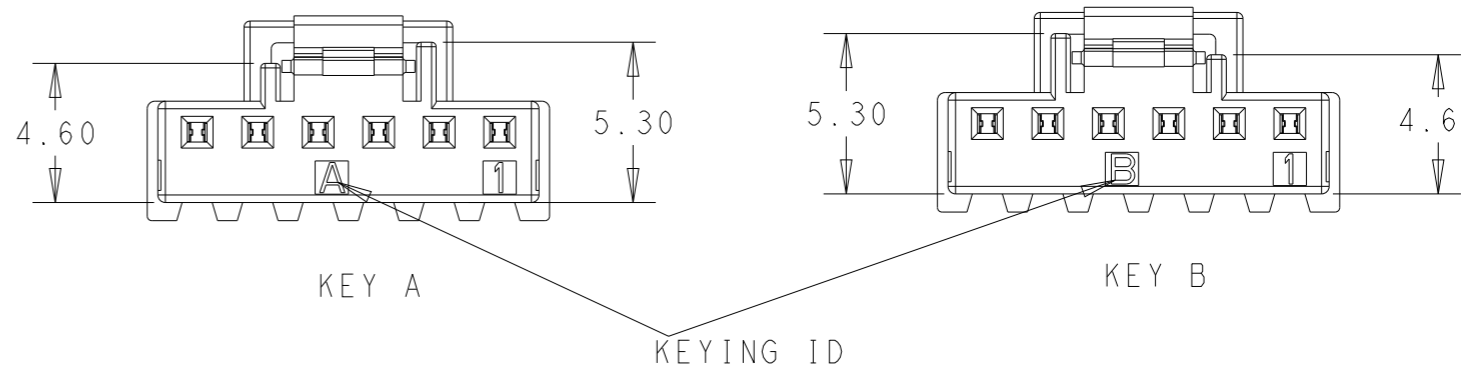
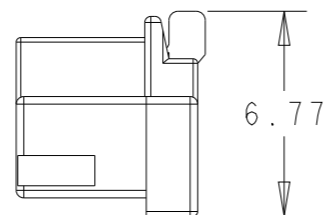
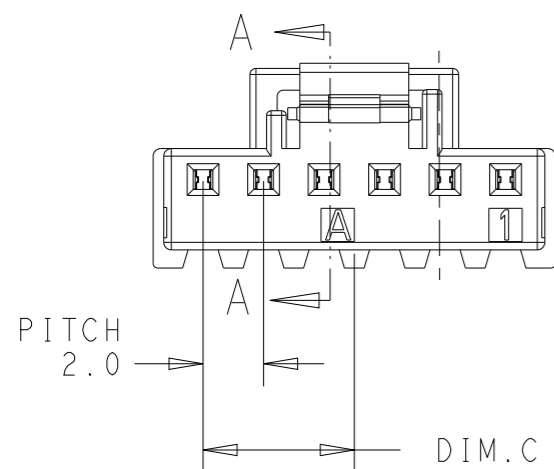

2-2232829-0	2-2232826-0	9.0	21.3	20.6	10	A	NATURAL	2-2232979-0
1-2232829-9	1-2232826-9	8.0	19.3	18.6	9			1-2232979-9
1-2232829-8	1-2232826-8	7.0	17.3	16.6	8			1-2232979-8
1-2232829-7	1-2232826-7	6.0	15.3	14.6	7			1-2232979-7
1-2232829-6	1-2232826-6	5.0	13.3	12.6	6			1-2232979-6
1-2232829-5	1-2232826-5	4.0	11.3	10.6	5			1-2232979-5
1-2232829-4	1-2232826-4	3.0	9.3	8.6	4			1-2232979-4
1-2232829-3	1-2232826-3	2.0	7.3	6.6	3			1-2232979-3
1-2232829-2	1-2232826-2	1.0	5.3	4.6	2			1-2232979-2
MATING PART_SMT	MATING PART_TH	DIM.C	DIM.B	DIM.A	POS.	KEYING	COLOR	ASSEMBLY PART NO.

THIS DRAWING IS A CONTROLLED DOCUMENT.

DWN CANDY XU 1SEP2017
 CHK DANIEL_Z 4SEP2017
 APVD DANIEL_Z 4SEP2017
 PRODUCT SPEC 108-106266
 APPLICATION SPEC 114-106266
 WEIGHT -



NAME PLUG ASSEMBLY, SGI 2.0mm

DIMENSIONS:	TOLERANCES UNLESS OTHERWISE SPECIFIED:
mm	
0 PLC	±-
1 PLC	±-
2 PLC	±0.15
3 PLC	±-
4 PLC	±-
ANGLES	±-
FINISH	±-

MATERIAL



SIZE	CAGE CODE	DRAWING NO	RESTRICTED TO
A3	00779	C-2232979	-

CUSTOMER DRAWING

SCALE 8:1 SHEET 1 OF 3 REV B1

THIS DRAWING IS UNPUBLISHED.

RELEASED FOR PUBLICATION

20

REVISIONS

© COPYRIGHT 20 BY -

ALL RIGHTS RESERVED.

P	LTR	DESCRIPTION	DATE	DWN	APVD
		SEE SHEET 1			

MATING PART_SMT	MATING PART_TH	DIM.C	DIM.B	DIM.A	POS.	KEYING	COLOR	ASSEMBLY PART NO.
3-2232829-0	3-2232826-0	9.0	21.3	20.6	10	B	NATURAL	3-2232979-0
2-2232829-9	2-2232826-9	8.0	19.3	18.6	9			2-2232979-9
2-2232829-8	2-2232826-8	7.0	17.3	16.6	8			2-2232979-8
2-2232829-7	2-2232826-7	6.0	15.3	14.6	7			2-2232979-7
2-2232829-6	2-2232826-6	5.0	13.3	12.6	6			2-2232979-6
2-2232829-5	2-2232826-5	4.0	11.3	10.6	5			2-2232979-5
2-2232829-4	2-2232826-4	3.0	9.3	8.6	4			2-2232979-4
2-2232829-3	2-2232826-3	2.0	7.3	6.6	3			2-2232979-3
2-2232829-2	2-2232826-2	1.0	5.3	4.6	2			2-2232979-2
4-2232829-0	4-2232826-0	9.0	21.3	20.6	10	A	BLACK	4-2232979-0
3-2232829-9	3-2232826-9	8.0	19.3	18.6	9			3-2232979-9
3-2232829-8	3-2232826-8	7.0	17.3	16.6	8			3-2232979-8
3-2232829-7	3-2232826-7	6.0	15.3	14.6	7			3-2232979-7
3-2232829-6	3-2232826-6	5.0	13.3	12.6	6			3-2232979-6
3-2232829-5	3-2232826-5	4.0	11.3	10.6	5			3-2232979-5
3-2232829-4	3-2232826-4	3.0	9.3	8.6	4			3-2232979-4
3-2232829-3	3-2232826-3	2.0	7.3	6.6	3			3-2232979-3
3-2232829-2	3-2232826-2	1.0	5.3	4.6	2			3-2232979-2
5-2232829-0	5-2232826-0	9.0	21.3	20.6	10	B	BLACK	5-2232979-0
4-2232829-9	4-2232826-9	8.0	19.3	18.6	9			4-2232979-9
4-2232829-8	4-2232826-8	7.0	17.3	16.6	8			4-2232979-8
4-2232829-7	4-2232826-7	6.0	15.3	14.6	7			4-2232979-7
4-2232829-6	4-2232826-6	5.0	13.3	12.6	6			4-2232979-6
4-2232829-5	4-2232826-5	4.0	11.3	10.6	5			4-2232979-5
4-2232829-4	4-2232826-4	3.0	9.3	8.6	4			4-2232979-4
4-2232829-3	4-2232826-3	2.0	7.3	6.6	3			4-2232979-3
4-2232829-2	4-2232826-2	1.0	5.3	4.6	2			4-2232979-2

THIS DRAWING IS A CONTROLLED DOCUMENT.		DWN CANDY XU 1SEP2017	TE Connectivity			
DIMENSIONS: mm		CHK DANIEL Z 4SEP2017				
TOLERANCES UNLESS OTHERWISE SPECIFIED:		APVD DANIEL Z 4SEP2017	NAME PLUG ASSEMBLY, SGI 2.0mm			
<ul style="list-style-type: none"> 0 PLC ±- 1 PLC ±- 2 PLC ±0.15 3 PLC ±- 4 PLC ±- ANGLES ±- FINISH ±- 		PRODUCT SPEC 108-106266	-			
MATERIAL		APPLICATION SPEC 114-106266	SIZE A3	CAGE CODE 00779	DRAWING NO C-2232979	RESTRICTED TO -
CUSTOMER DRAWING			SCALE 8:1	SHEET 2 OF 3	REV B1	

P	LTR	DESCRIPTION	DATE	DWN	APVD
		SEE SHEET 1 SEE SHEET 1			

KEYING A SHOWN FOR 2 THRU 10 POS.

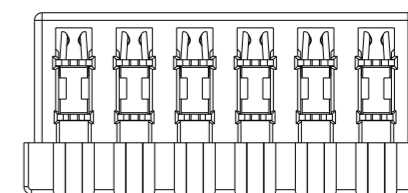
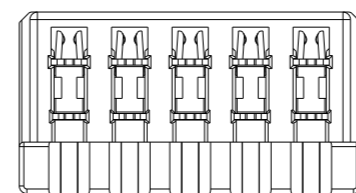
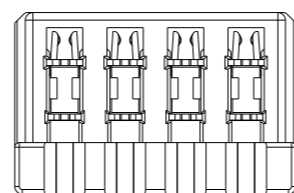
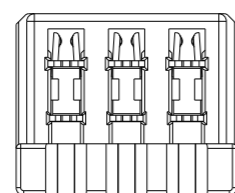
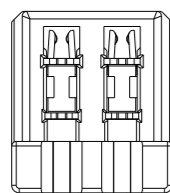
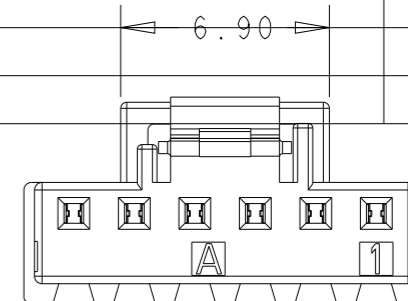
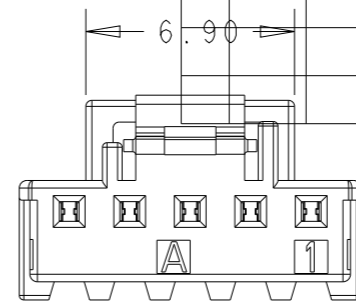
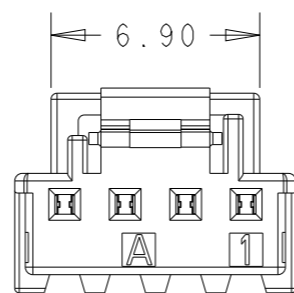
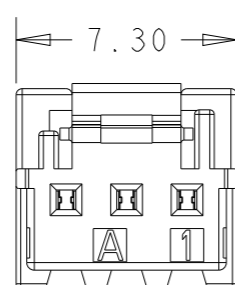
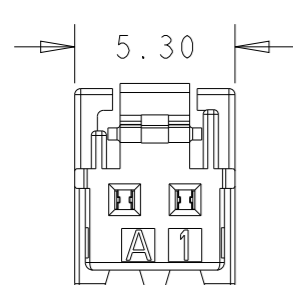

2POS.

3POS.

4POS.

5POS.

6POS.

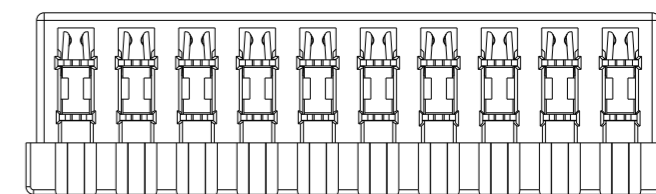
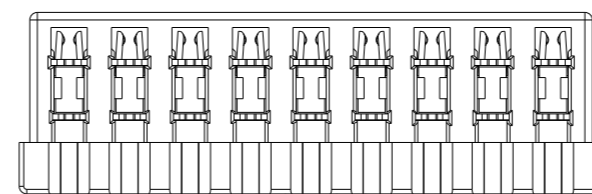
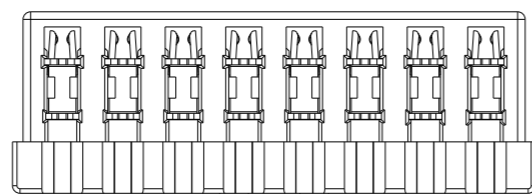
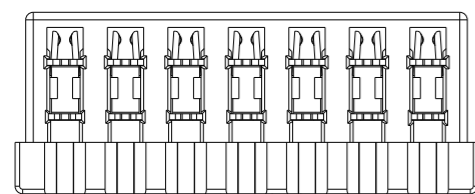
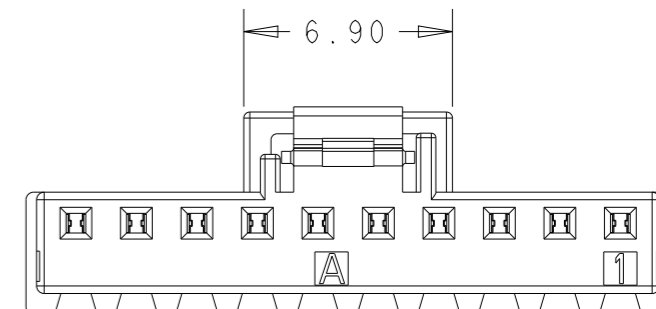
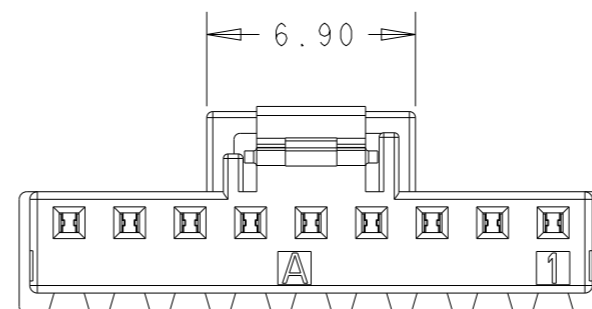
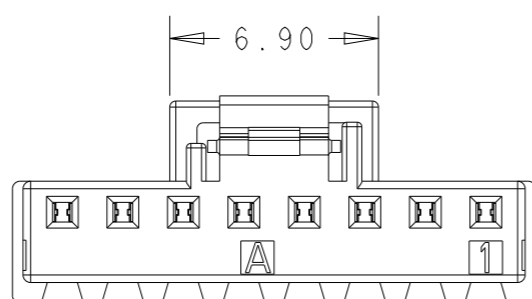
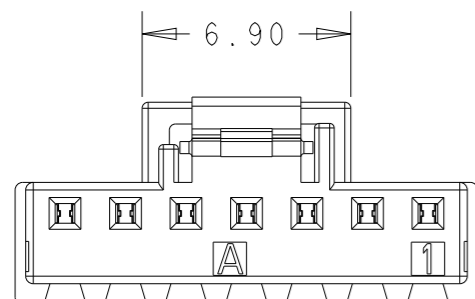

7POS.

8POS.

9POS.

10POS.

THIS DRAWING IS A CONTROLLED DOCUMENT.

DWN CANDY XU 1SEP2017

CHK DANIEL Z 4SEP2017

APVD DANIEL Z 4SEP2017

PRODUCT SPEC 108-106266

APPLICATION SPEC 114-106266

WEIGHT -

CUSTOMER DRAWING

STE TE Connectivity

NAME PLUG ASSEMBLY, SGI 2.0mm

SIZE CAGE CODE DRAWING NO RESTRICTED TO

A300779 C-2232979

SCALE 8:1 SHEET 3 OF 3 REV B1

DIMENSIONS: mm

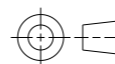

TOLERANCES UNLESS OTHERWISE SPECIFIED:

- 0 PLC ±-
- 1 PLC ±-
- 2 PLC ±0.15
- 3 PLC ±-
- 4 PLC ±-
- ANGLES ±-
- FINISH ±-

