

SDCHA1V60

Automotive grade semi-shielded power inductors



Product features

- AEC-Q200 qualified
- High current carrying capacity
- High power density, low core losses
- Magnetically semi-shielded
- Inductance range from 1 μH to 100 μH
- Current range from 0.92 A to 13.5 A
- 6.3 mm x 6.3 mm surface mount package in a maximum 4.5 mm height
- NiZn ferrite magnetic material
- Moisture sensitivity level (MSL): 1

Applications

- LED lighting
- Advanced driver assistance systems (ADAS)
- Adaptive cruise control (ACC)
- Collision avoidance
- Infotainment and cluster electronics
- Electronic control unit (ECU)

Environmental compliance and general specifications

- Storage temperature range (component): -55 °C to +125 °C
- Operating temperature range: -55 °C to +125 °C (ambient plus self-temperature rise)
- Solder reflow temperature: J-STD-020 (latest revision) compliant



Product specifications

Part number ⁵	OCL ¹ (μ H)	Tolerance	FLL ² (μ H) minimum	I _{DC} ³ (A)	I _{sat} ⁴ (A)	DCR (m Ω) \pm 20% @ +25 °C	SRF (MHz) typical
SDCHA1V6045-1R0-R	1.0	\pm 20%	0.56	8.0	13.5	10	110
SDCHA1V6045-1R2-R	1.2	\pm 20%	0.67	7.5	12.5	10.5	90
SDCHA1V6045-1R5-R	1.5	\pm 20%	0.84	7.0	12.0	11.7	75
SDCHA1V6045-1R8-R	1.8	\pm 20%	1.01	6.8	11.0	12	70
SDCHA1V6045-2R2-R	2.2	\pm 20%	1.23	6.0	9.5	15	55
SDCHA1V6045-3R3-R	3.3	\pm 20%	1.85	5.0	7.8	21	45
SDCHA1V6045-3R6-R	3.6	\pm 20%	2.02	4.9	7.4	22.5	42
SDCHA1V6045-4R7-R	4.7	\pm 20%	2.63	4.5	6.8	26	40
SDCHA1V6045-5R6-R	5.6	\pm 20%	3.14	4.1	6.4	31	35
SDCHA1V6045-6R8-R	6.8	\pm 20%	3.81	3.6	5.7	34	30
SDCHA1V6045-8R2-R	8.2	\pm 20%	4.59	3.4	5.1	46	27
SDCHA1V6045-100-R	10	\pm 20%	5.60	3.2	4.6	52	25
SDCHA1V6045-150-R	15	\pm 20%	8.40	2.8	3.8	71	20
SDCHA1V6045-220-R	22	\pm 20%	12.32	2.3	3.3	96	17
SDCHA1V6045-330-R	33	\pm 20%	18.48	1.8	2.5	145	13
SDCHA1V6045-470-R	47	\pm 20%	26.32	1.6	2.0	200	12
SDCHA1V6045-560-R	56	\pm 20%	31.36	1.4	1.8	230	11
SDCHA1V6045-680-R	68	\pm 20%	38.08	1.1	1.6	305	10
SDCHA1V6045-820-R	82	\pm 20%	45.92	0.98	1.5	365	9
SDCHA1V6045-101-R	100	\pm 20%	56.00	0.92	1.33	456	8.5

1. Open circuit inductance (OCL) test parameters: 100 kHz, 1.0 Vrms, 0.0 Adc, +25 °C

2. Full load inductance (FLL) test parameters: 100 kHz, 1.0 Vrms, I_{DC}, +25 °C

3. I_{DC}: DC current for an approximate temperature rise of 40 °C without core loss. Derating is necessary for AC currents.

PCB layout, trace thickness and width, air-flow, and proximity of other heat generating components will affect the temperature rise. It is recommended that the temperature of the part not exceed +125 °C under worst case operating conditions verified in the end application.

4. I_{sat}: Peak current for approximately 30% maximum rolloff @ +25 °C

5. Part number definition: SDCHA1V6045-xxx-R

SDCHA1V6045 = Product code and size

xxx= Inductance value in μ H, R=decimal point, If no R is present last digit indicates number of zeros

-R suffix = RoHS compliant

6. Rated operating voltage (across inductor) 20 V ref.

Dimensions-mm

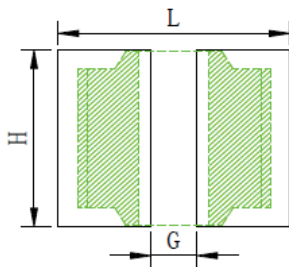
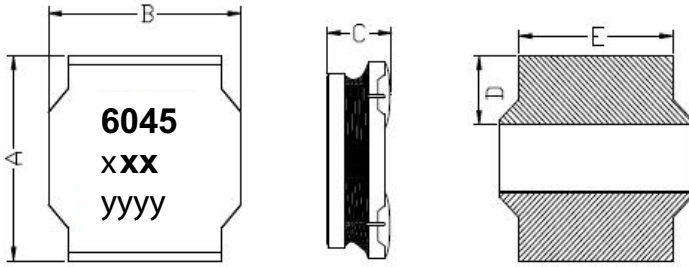

Recommended PCB Layout

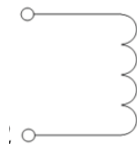

Schematic

Dimension	SDCHA1V6045-xxx-R
A	6.0 ± 0.3
B	6.0 ± 0.3
C	4.2 ± 0.3
D	1.9 ± 0.3
E	4.8 ± 0.3
L	7.22
G	1.42
H	6.12

Part marking: 6045, xxx= inductance value in uH, R= decimal point. If no R is present then last character equals number of zeros, yyyy= lot code

All soldering surfaces to be coplanar within 0.1 millimeters

PCB layout reference only

Recommend solder paste thickness at 0.15 mm and above

Traces or vias underneath the inductor is not recommended

Packaging information- mm

SDCHA1V6045

Supplied in tape and reel packaging, 1000 parts per 13" diameter reel (EIA-481 compliant)

Drawing not to scale

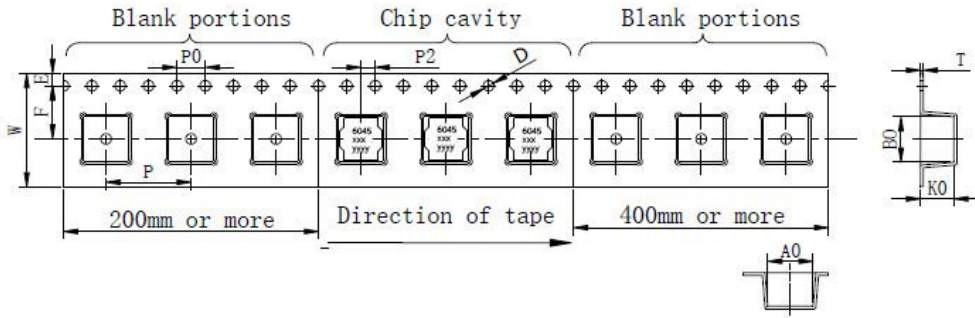

Dimension	Value
W	16.0 ± 0.3
F	7.5 ± 0.1
E	1.75 ± 0.1
P0	4.0 ± 0.1
P	12.0 ± 0.1
P2	2.0 ± 0.1
D	1.5 ± 0.1
A0	6.4 ± 0.1
B0	6.4 ± 0.1
K0	4.7 ± 0.1
T	0.4 ± 0.1

Inductance and temperature rise vs current
SDCHA1V6045

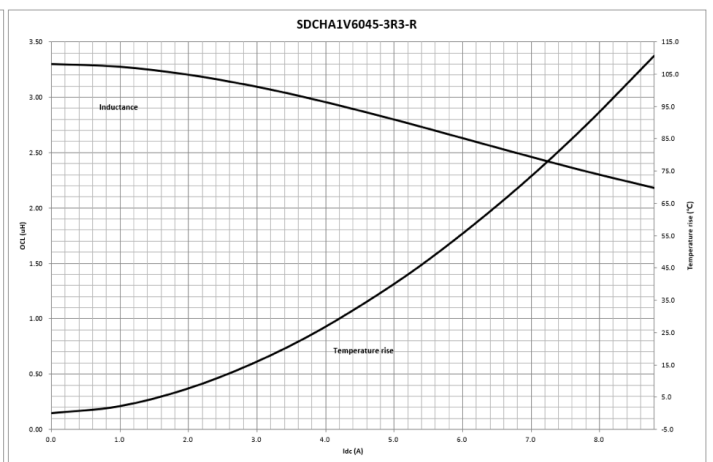
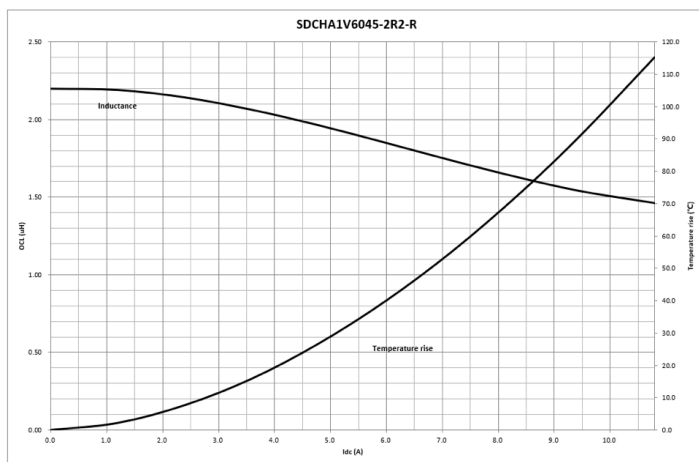
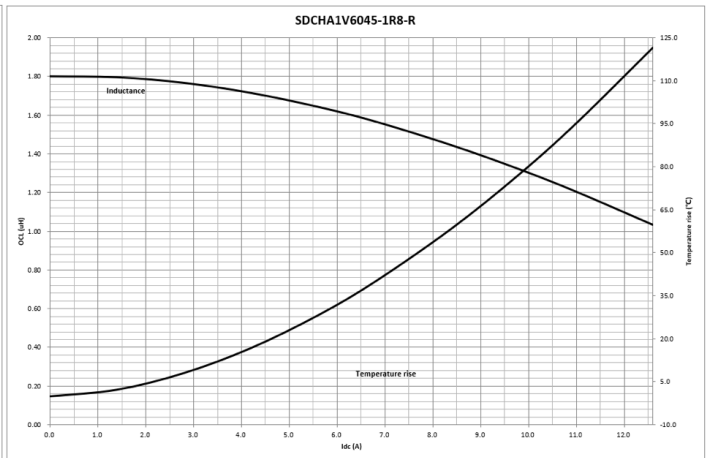
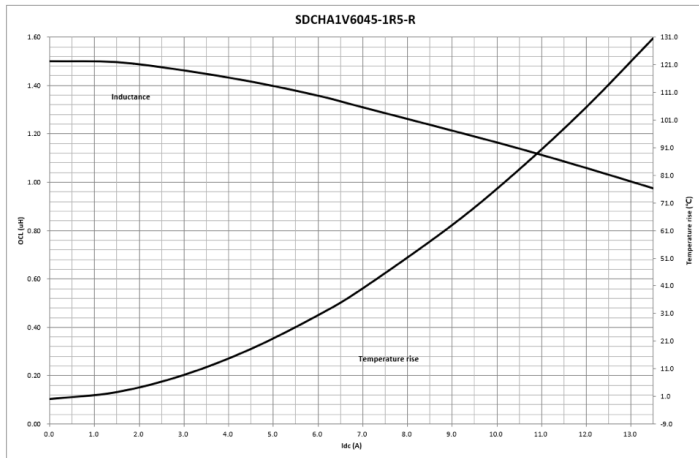
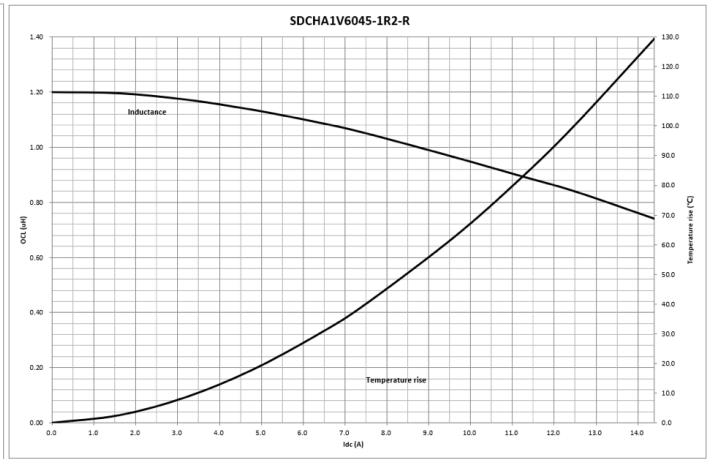
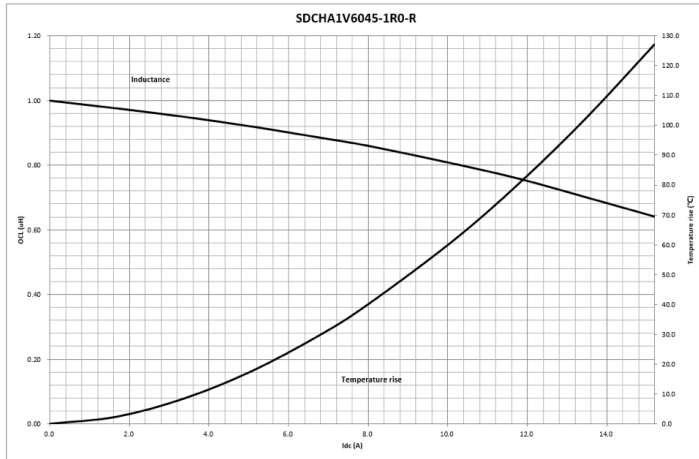

Inductance and temperature rise vs current

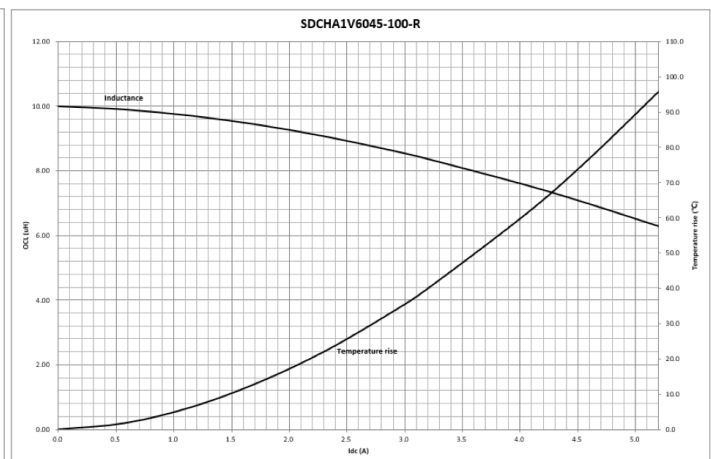
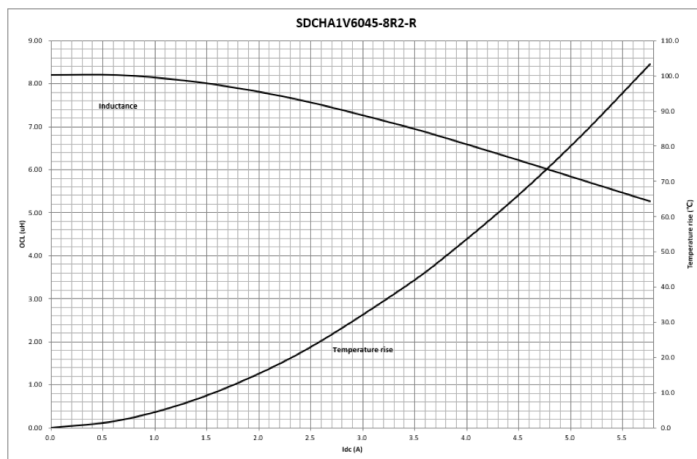
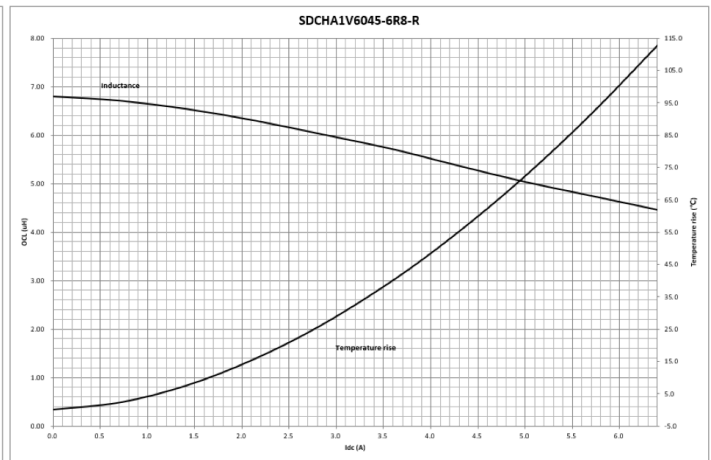
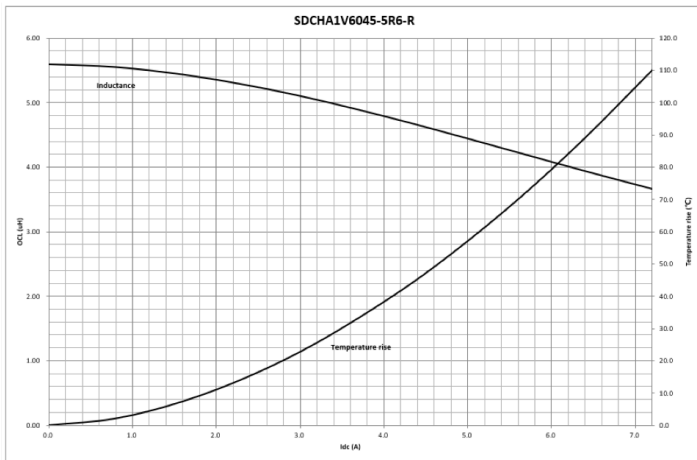
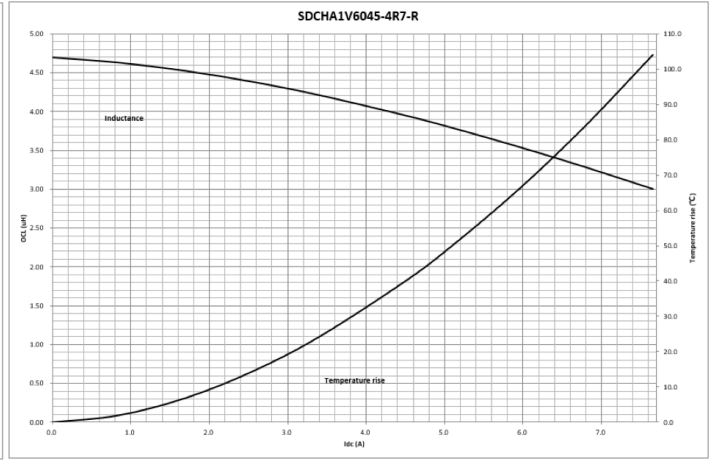
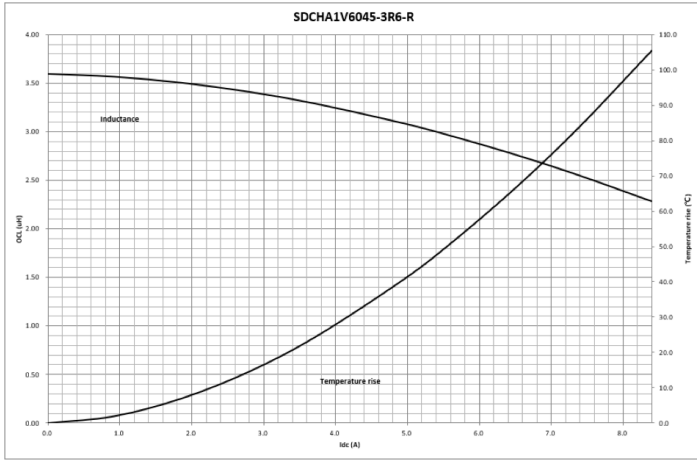

Inductance and temperature rise vs current

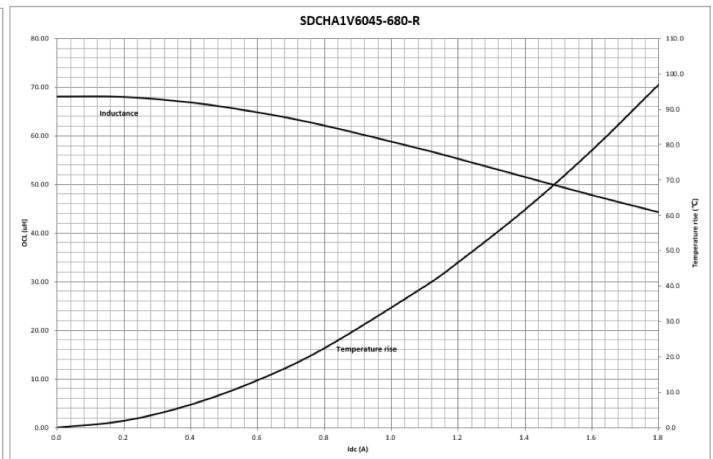
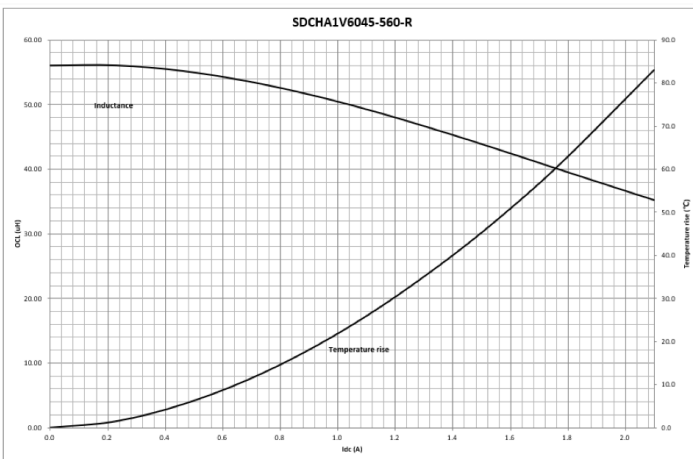
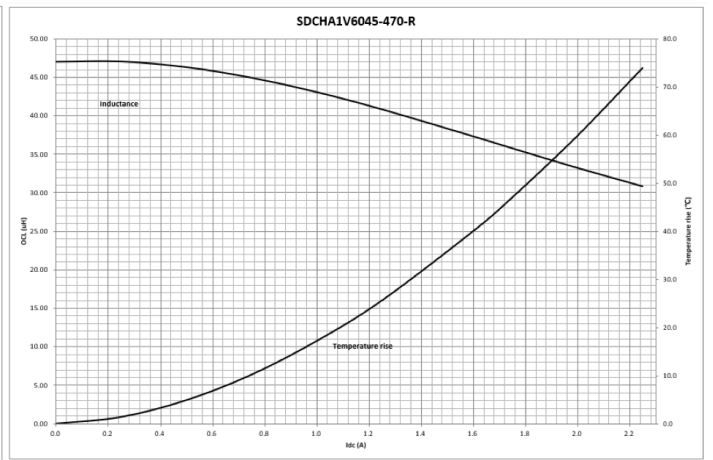
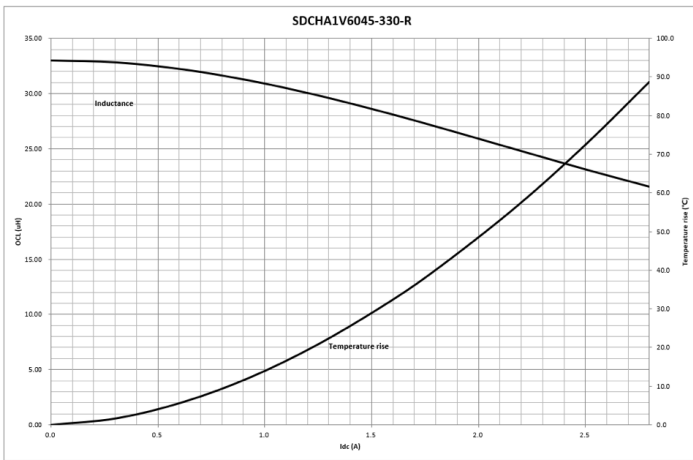
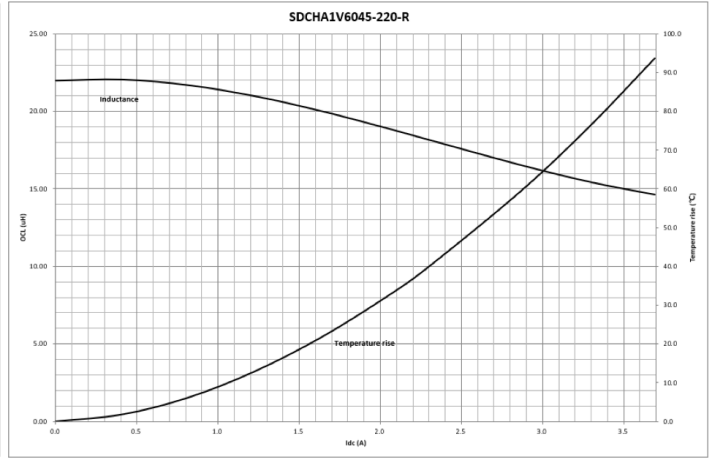
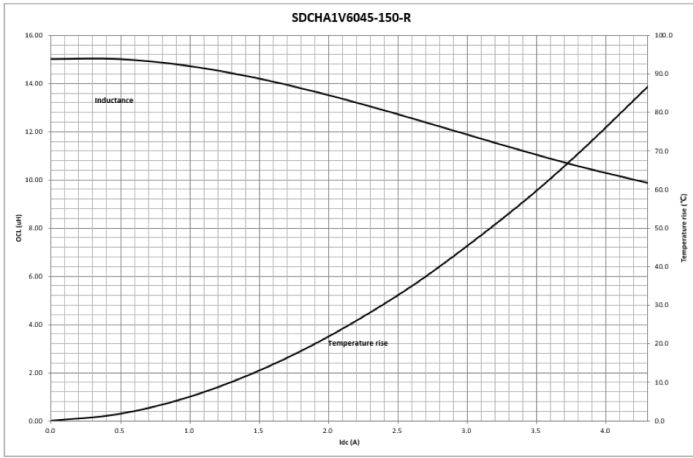

Inductance and temperature rise vs current

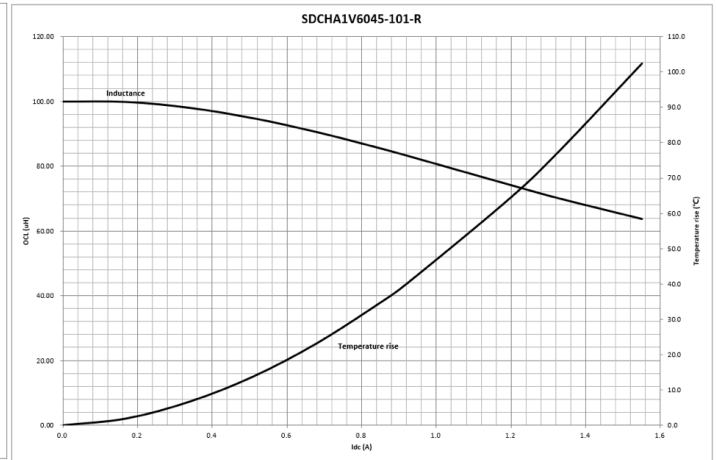
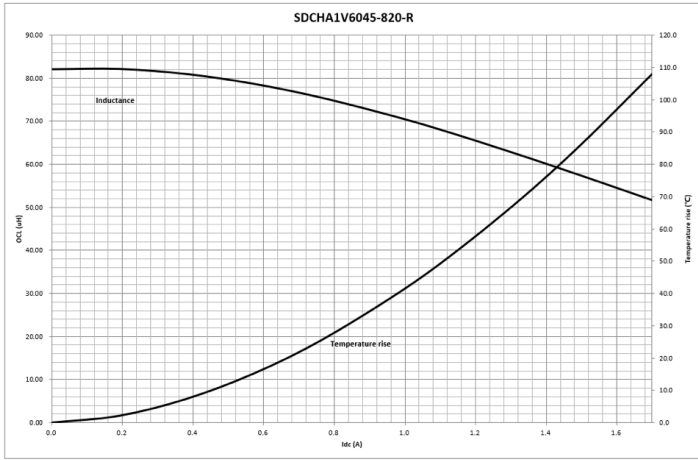

Inductance and impedance vs. frequency curve

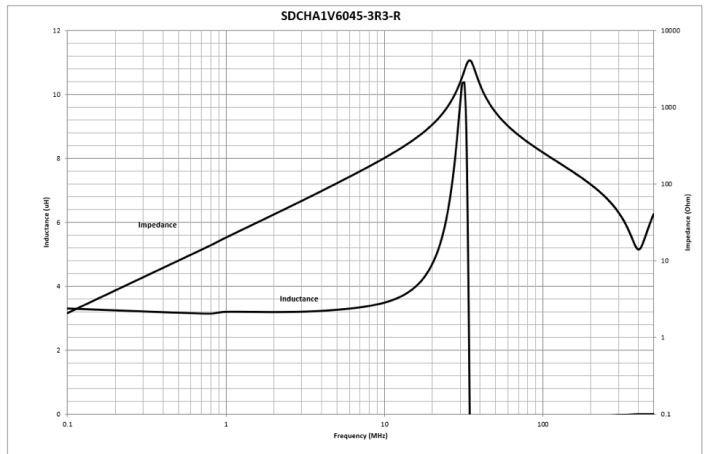
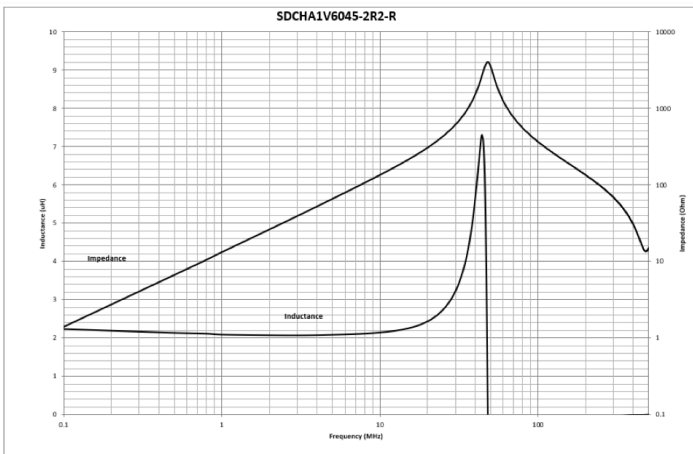
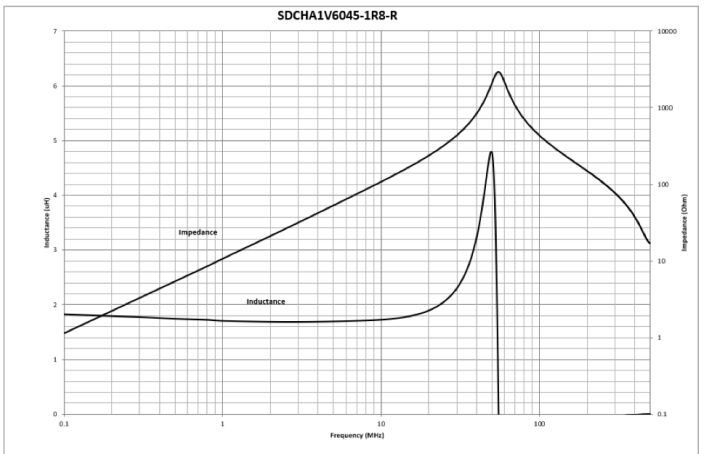
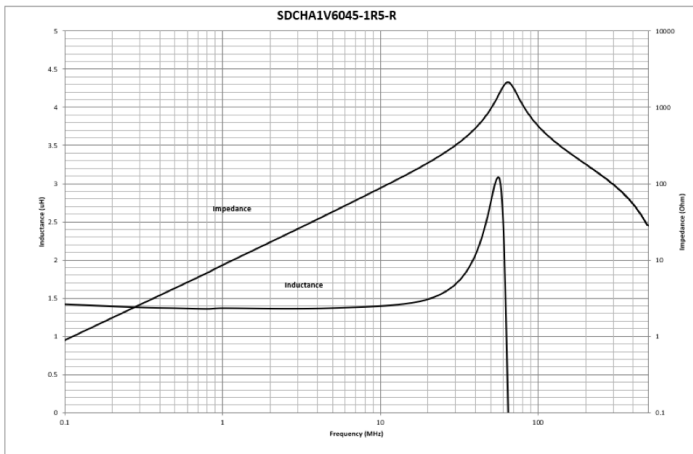
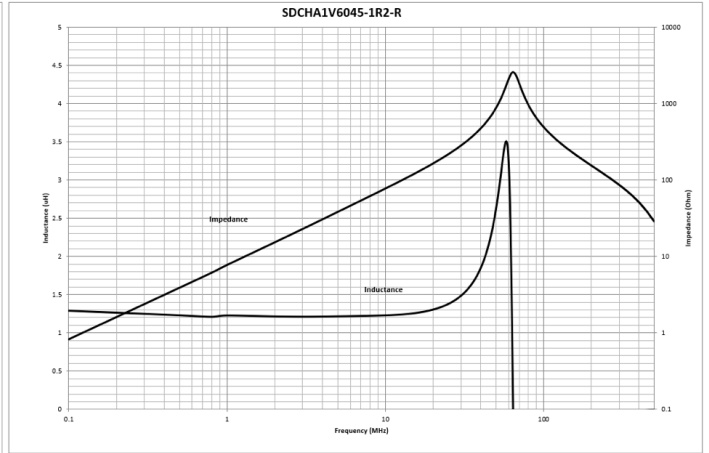
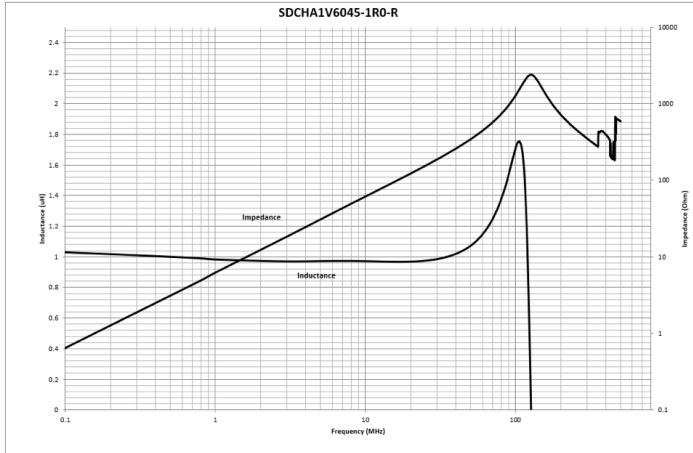

Inductance and impedance vs. frequency curve

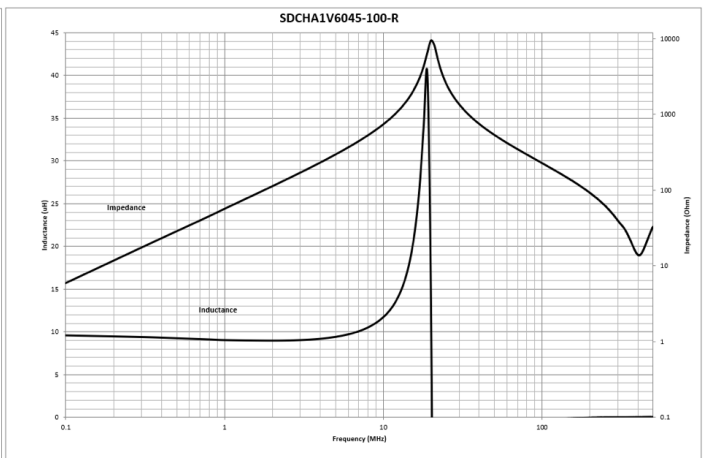
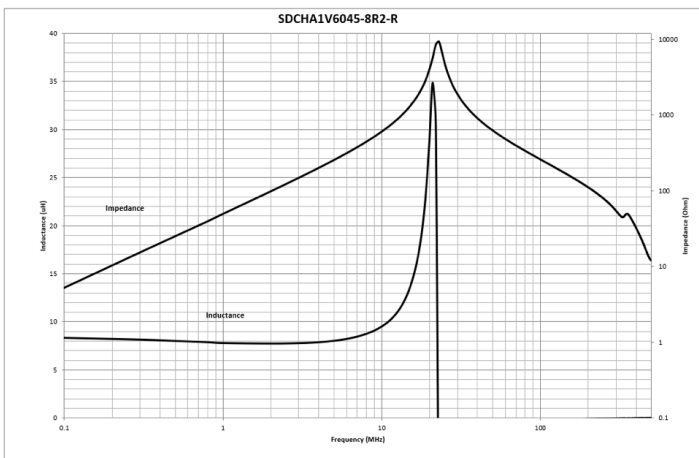
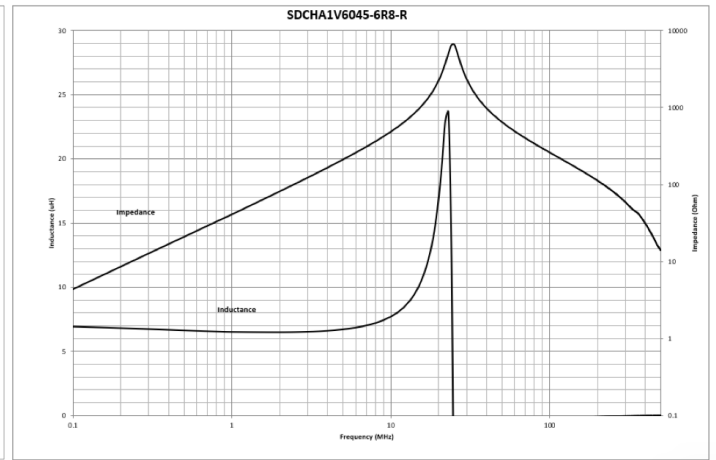
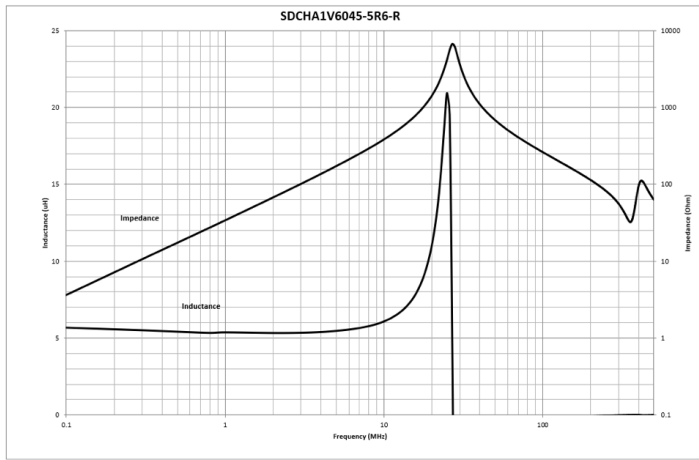
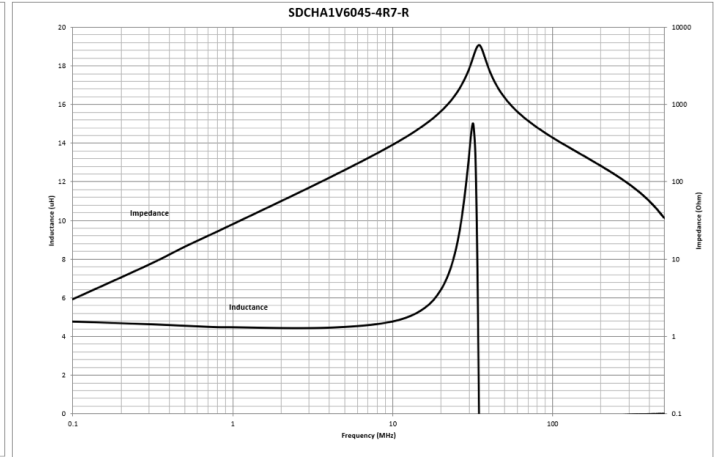
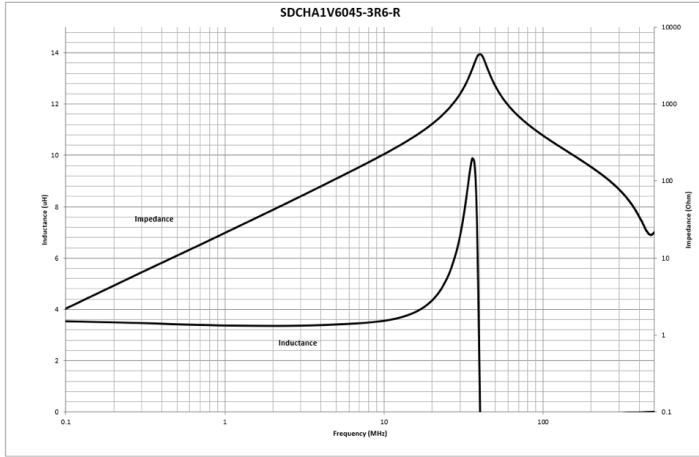

Inductance and impedance vs. frequency curve

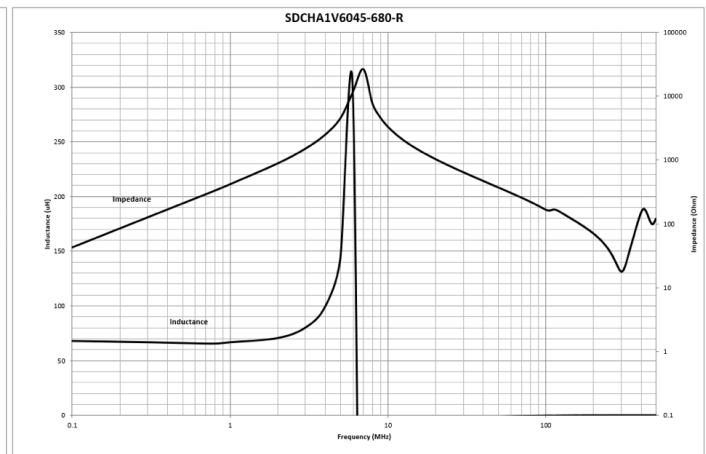
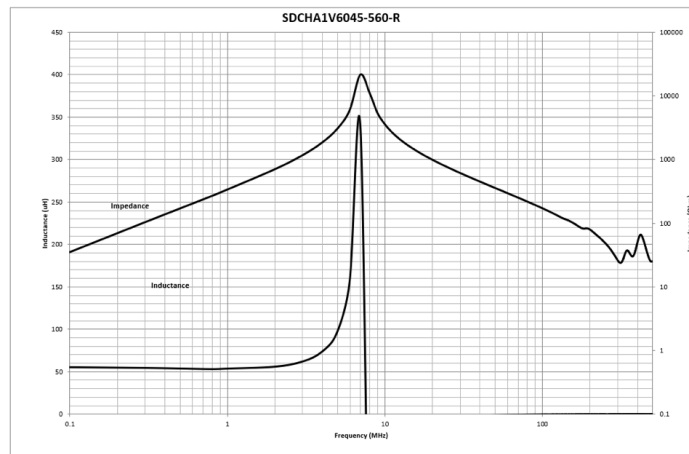
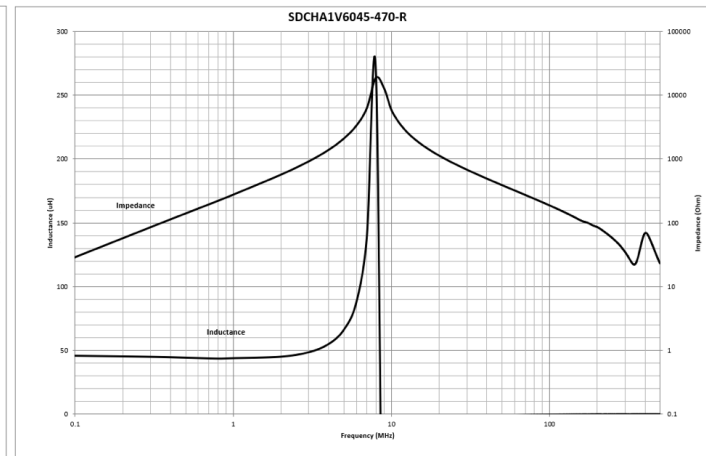
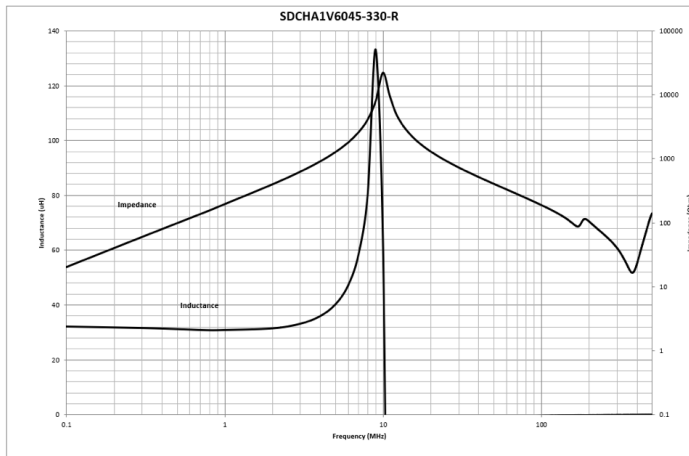
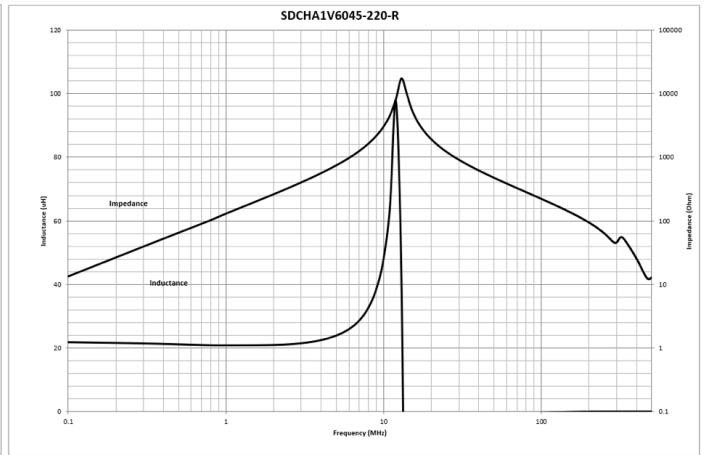
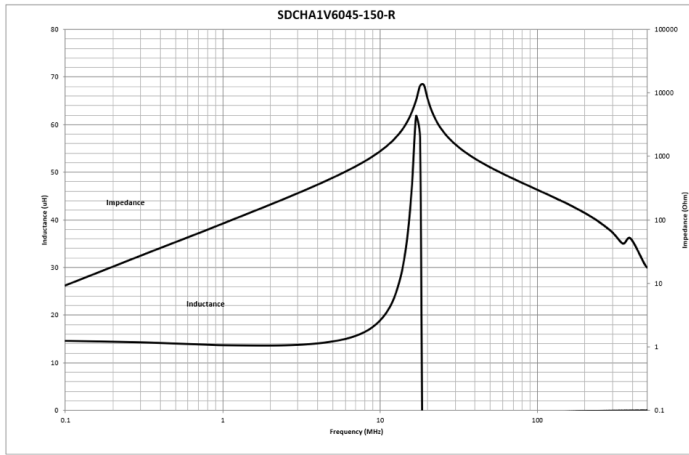

Inductance and impedance vs. frequency curve

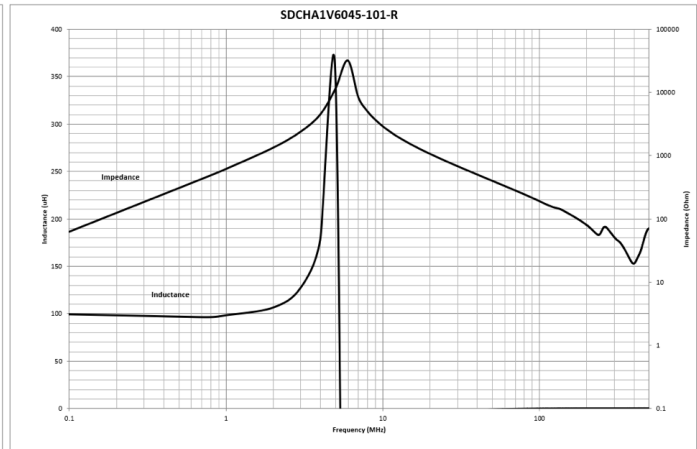
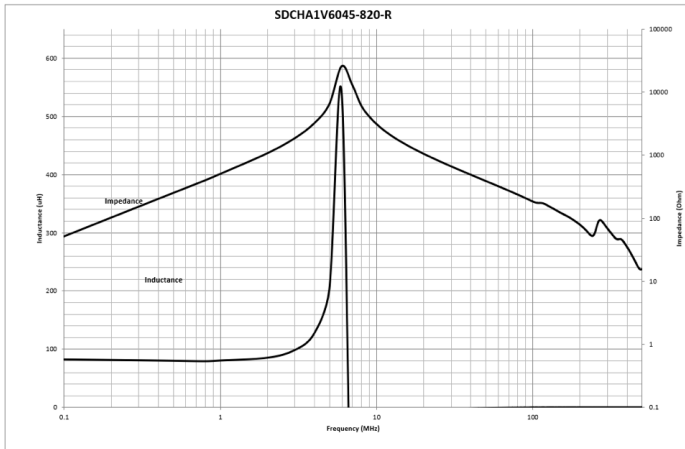

Solder reflow profile

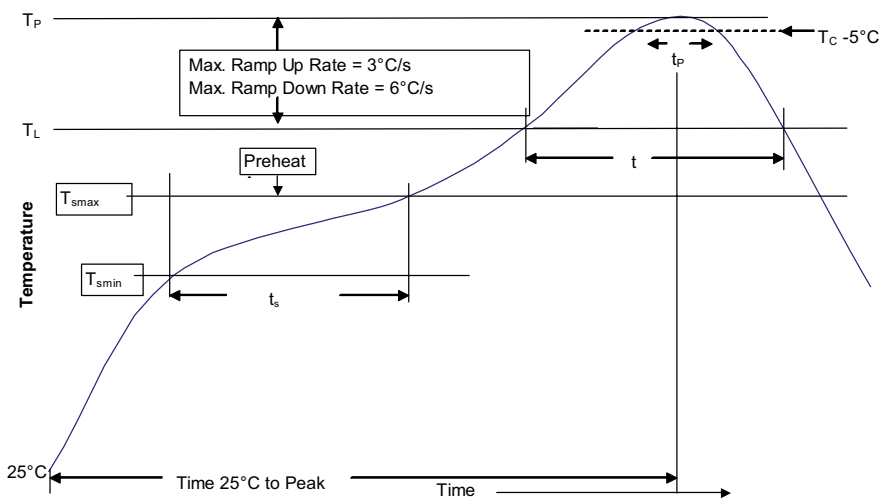

Table 1 - Standard SnPb solder (T_C)

Package thickness	Volume mm ³ <350	Volume mm ³ ≥350
<2.5 mm	235 °C	220 °C
≥2.5 mm	220 °C	220 °C

Table 2 - Lead (Pb) free solder (T_C)

Package thickness	Volume mm ³ <350	Volume mm ³ 350 - 2000	Volume mm ³ >2000
<1.6 mm	260 °C	260 °C	260 °C
1.6 – 2.5 mm	260 °C	250 °C	245 °C
>2.5 mm	250 °C	245 °C	245 °C

Reference J-STD-020

Profile feature	Standard SnPb solder	Lead (Pb) free solder
Preheat and soak		
• Temperature min. (T _{smin})	100 °C	150 °C
• Temperature max. (T _{smax})	150 °C	200 °C
• Time (T _{smin} to T _{smax}) (t _s)	60-120 seconds	60-120 seconds
Ramp up rate T _L to T _p	3 °C/ second max.	3 °C/ second max.
Liquidous temperature (T _L)	183 °C	217 °C
Time (t _L) maintained above T _L	60-150 seconds	60-150 seconds
Peak package body temperature (T _p)*	Table 1	Table 2
Time (t _p)* within 5 °C of the specified classification temperature (T _C)	20 seconds*	30 seconds*
Ramp-down rate (T _p to T _L)	6 °C/ second max.	6 °C/ second max.
Time 25 °C to peak temperature	6 minutes max.	8 minutes max.

* Tolerance for peak profile temperature (T_p) is defined as a supplier minimum and a user maximum.

Life Support Policy: Eaton does not authorize the use of any of its products for use in life support devices or systems without the express written approval of an officer of the Company. Life support systems are devices which support or sustain life, and whose failure to perform, when properly used in accordance with instructions for use provided in the labeling, can be reasonably expected to result in significant injury to the user.

Eaton reserves the right, without notice, to change design or construction of any products and to discontinue or limit distribution of any products. Eaton also reserves the right to change or update, without notice, any technical information contained in this bulletin.

Eaton
Electronics Division
1000 Eaton Boulevard
Cleveland, OH 44122
United States
Eaton.com/electronics

© 2022 Eaton
All Rights Reserved
Printed in USA
Publication No. ELX1096
December 2022

Eaton is a registered trademark.
All other trademarks are property of their respective owners.

Follow us on social media to get the latest product and support information.

