

OSRAM CUW Y3SH.B2

Datasheet

Published by **ams-OSRAM AG**

Tobelbader Strasse 30, 8141 Premstaetten, Austria

Phone +43 3136 500-0

ams-osram.com

© All rights reserved



Micro SIDELED® 3806

CUW Y3SH.B2

Micro SIDELED is a SMT LED with side emission. Due to its low package height it is ideal for applications in limited space environments.

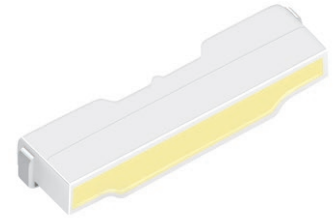

Applications

- Access Control & Security
- Factory Automation
- Home & Building Automation
- Material Processing
- Projection & Display
- Robotics

Features

- Package: white SMT package, colored diffused silicone resin
- Chip technology: InGaN on Sapphire
- Typ. Radiation: 120° (Lambertian emitter)
- Color: $C_x = 0.3050$, $C_y = 0.3026$ acc. to CIE 1931 (• ultra white)
- Optical efficacy: 180 lm/W
- Corrosion Robustness Class: 1B
- ESD: 2 kV acc. to ANSI/ESDA/JEDEC JS-001 (HBM)

Ordering Information

Type	Luminous Flux ¹⁾ $I_F = 20 \text{ mA}$ Φ_V	Ordering Code
CUW Y3SH.B2-GFJD-5J6T-Z242-Z	9750 ... 11500 mlm	Q65113A2530

Maximum Ratings

Parameter	Symbol		Values
Operating Temperature	T_{op}	min. max.	-40 °C 85 °C
Storage Temperature	T_{stg}	min. max.	-40 °C 100 °C
Junction Temperature	T_j	max.	105 °C
Forward current $T_s = 25\text{ °C}$	I_F	max.	40 mA
Surge Current $t \leq 10\text{ }\mu\text{s}$; $D = 0.005$; $T_s = 25\text{ °C}$	I_{FS}	max.	100 mA
Reverse voltage ²⁾ $T_s = 25\text{ °C}$	V_R	max.	5 V
ESD withstand voltage acc. to ANSI/ESDA/JEDEC JS-001 (HBM)	V_{ESD}		2 kV

Characteristics

$I_F = 20 \text{ mA}$; $T_S = 25 \text{ °C}$

Parameter	Symbol		Values
Chromaticity Coordinate ³⁾	C_x	typ.	0.3050
	C_y	typ.	0.3026
Viewing angle at 50% I_V	2ϕ	typ.	120 °
Forward Voltage ⁴⁾ $I_F = 20 \text{ mA}$	V_F	min.	2.70 V
		typ.	2.85 V
		max.	3.00 V
Reverse current ²⁾ $V_R = 5 \text{ V}$	I_R	typ.	0.01 μA
		max.	10 μA
Real thermal resistance junction/solderpoint ⁵⁾	$R_{\text{thJS real}}$	typ.	54 K / W
		max.	64 K / W
Electrical thermal resistance junction/solderpoint ⁵⁾ with efficiency $\eta_e = 18 \%$	$R_{\text{thJS elec.}}$	typ.	44 K / W
		max.	53 K / W

Brightness Groups

Group	Luminous Flux ¹⁾ $I_F = 20 \text{ mA}$ min. Φ_V	Luminous Flux ¹⁾ $I_F = 20 \text{ mA}$ max. Φ_V	Luminous Intensity ⁶⁾ $I_F = 20 \text{ mA}$ typ. I_V
GF	9750 mlm	10000 mlm	3260 mcd
HC	10000 mlm	10250 mlm	3340 mcd
HD	10250 mlm	10500 mlm	3420 mcd
HE	10500 mlm	10750 mlm	3510 mcd
HF	10750 mlm	11000 mlm	3590 mcd
JC	11000 mlm	11250 mlm	3670 mcd
JD	11250 mlm	11500 mlm	3750 mcd

Forward Voltage Groups

Group	Forward Voltage ⁴⁾ $I_F = 20 \text{ mA}$ min. V_F	Forward Voltage ⁴⁾ $I_F = 20 \text{ mA}$ max. V_F
Z2	2.70 V	2.80 V
22	2.80 V	2.90 V
42	2.90 V	3.00 V

Chromaticity Coordinate Groups

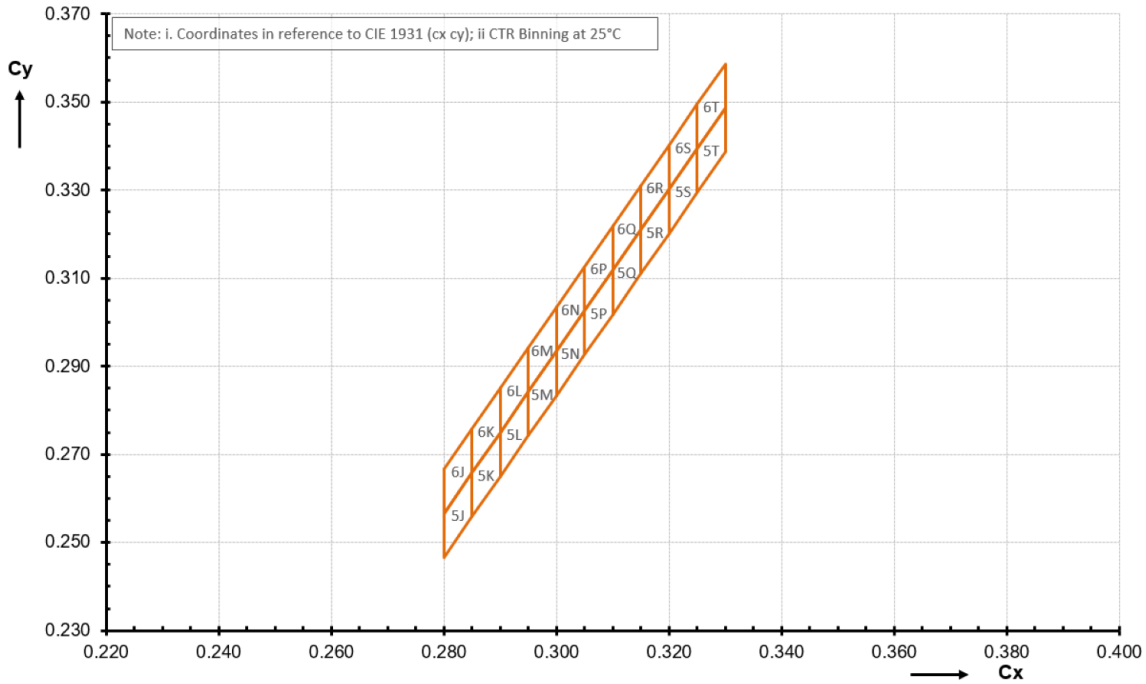

Chromaticity Coordinate Groups ³⁾

Group	Cx	Cy	Group	Cx	Cy	Group	Cx	Cy
5J	0.2850	0.2658	5N	0.3050	0.3026	5S	0.3250	0.3394
	0.2850	0.2558		0.3050	0.2926		0.3250	0.3294
	0.2800	0.2466		0.3000	0.2834		0.3200	0.3202
	0.2800	0.2566		0.3000	0.2934		0.3200	0.3302
5K	0.2900	0.2750	5P	0.3100	0.3118	5T	0.3300	0.3486
	0.2900	0.2650		0.3100	0.3018		0.3300	0.3386
	0.2850	0.2558		0.3050	0.2926		0.3250	0.3294
	0.2850	0.2658		0.3050	0.3026		0.3250	0.3394
5L	0.2950	0.2842	5Q	0.3150	0.3210	6J	0.2850	0.2758
	0.2950	0.2742		0.3150	0.3110		0.2850	0.2658
	0.2900	0.2650		0.3100	0.3018		0.2800	0.2566
	0.2900	0.2750		0.3100	0.3118		0.2800	0.2666
5M	0.3000	0.2934	5R	0.3200	0.3302	6K	0.2900	0.2850
	0.3000	0.2834		0.3200	0.3202		0.2900	0.2750
	0.2950	0.2742		0.3150	0.3110		0.2850	0.2658
	0.2950	0.2842		0.3150	0.3210		0.2850	0.2758

Group	Cx	Cy	Group	Cx	Cy	Group	Cx	Cy
6L	0.2950	0.2942	6P	0.3100	0.3218	6S	0.3250	0.3494
	0.2950	0.2842		0.3100	0.3118		0.3250	0.3394
	0.2900	0.2750		0.3050	0.3026		0.3200	0.3302
	0.2900	0.2850		0.3050	0.3126		0.3200	0.3402
6M	0.3000	0.3034	6Q	0.3150	0.3310	6T	0.3300	0.3586
	0.3000	0.2934		0.3150	0.3210		0.3300	0.3486
	0.2950	0.2842		0.3100	0.3118		0.3250	0.3394
	0.2950	0.2942		0.3100	0.3218		0.3250	0.3494
6N	0.3050	0.3126	6R	0.3200	0.3402			
	0.3050	0.3026		0.3200	0.3302			
	0.3000	0.2934		0.3150	0.3210			
	0.3000	0.3034		0.3150	0.3310			

Group Name on Label

Example: GF-5J-22

Brightness	Color Chromaticity	Forward Voltage
GF	5J	22

Relative Spectral Emission ⁶⁾

$I_{rel} = f(\lambda)$; $I_F = 20 \text{ mA}$; $T_S = 25 \text{ }^\circ\text{C}$

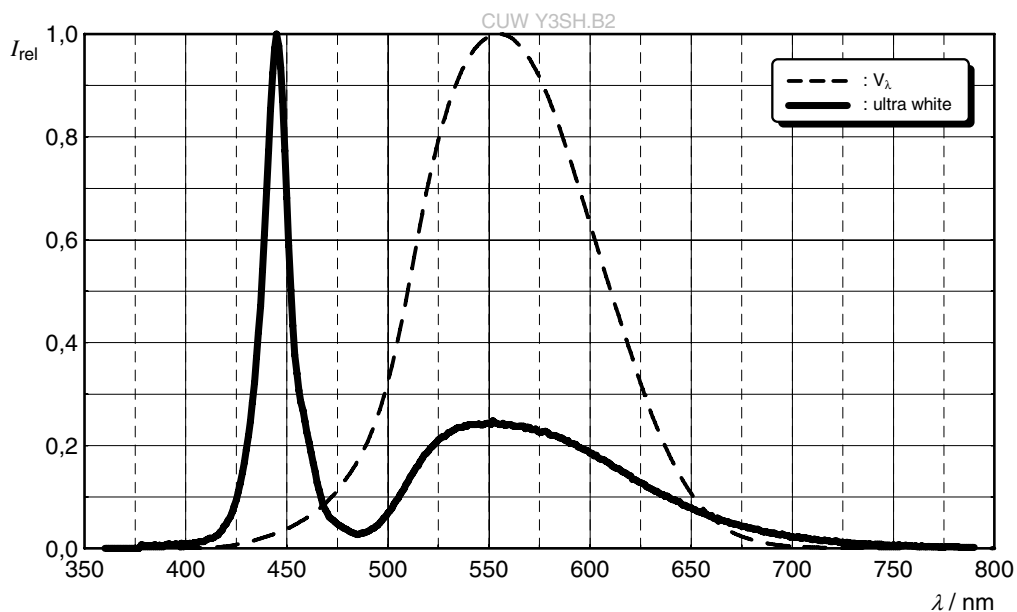

Radiation Characteristics ⁶⁾

$I_{rel} = f(\phi)$; $T_S = 25 \text{ }^\circ\text{C}$

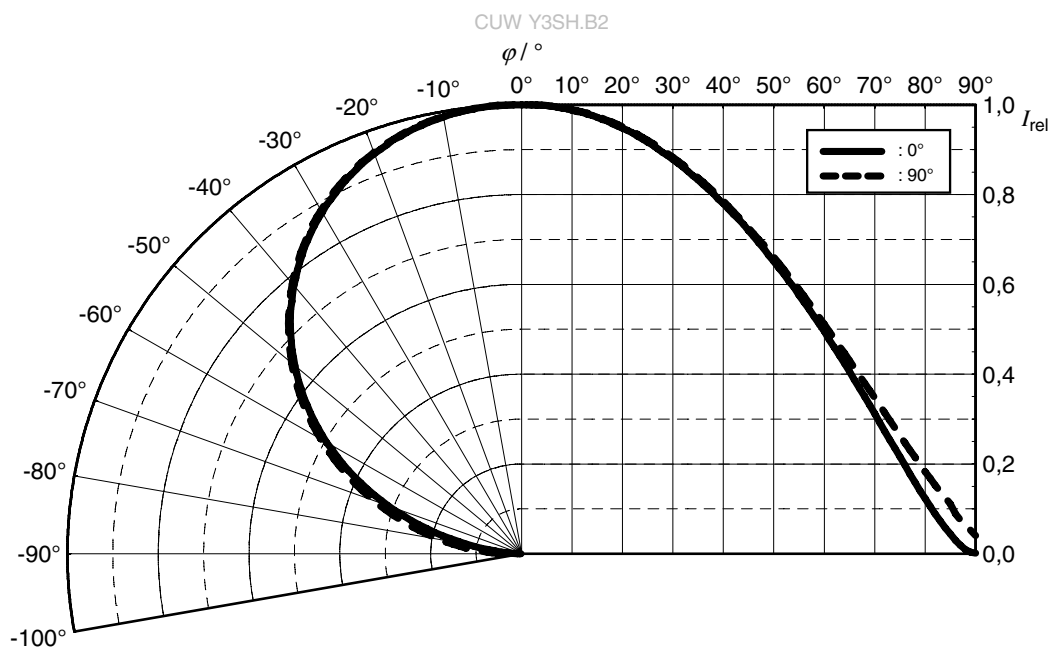

Forward current ⁶⁾

$I_F = f(V_F); T_s = 25\text{ °C}$

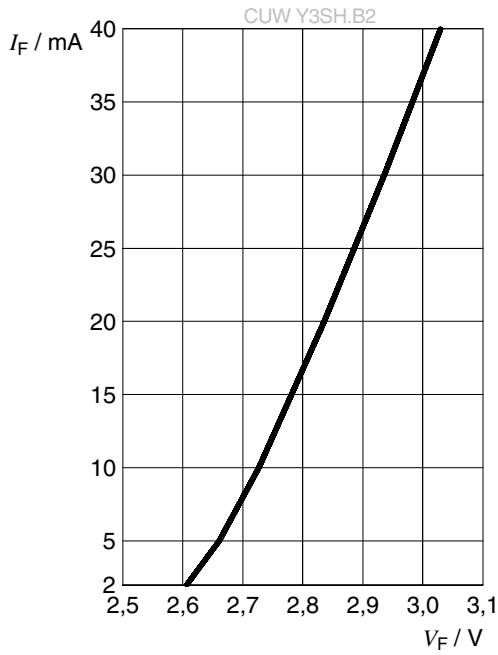

Relative Luminous Flux ^{6), 7)}

$\Phi_V / \Phi_V(20\text{ mA}) = f(I_F); T_s = 25\text{ °C}$

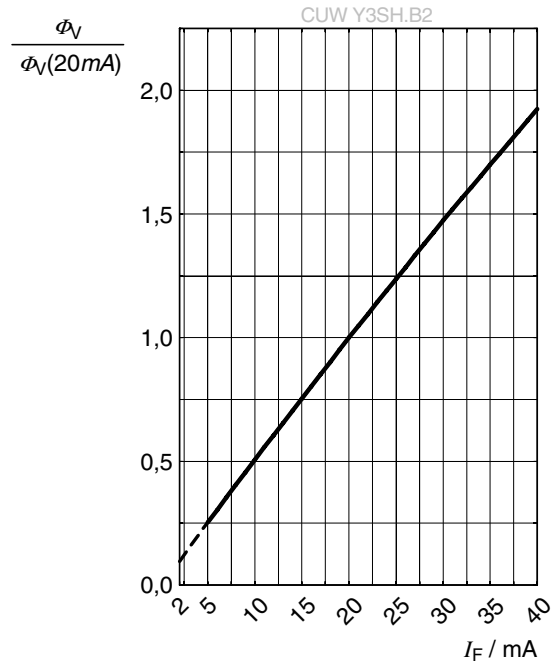

Chromaticity Coordinate Shift ⁶⁾

$\Delta C_x, \Delta C_y = f(I_F); T_s = 25\text{ °C}$

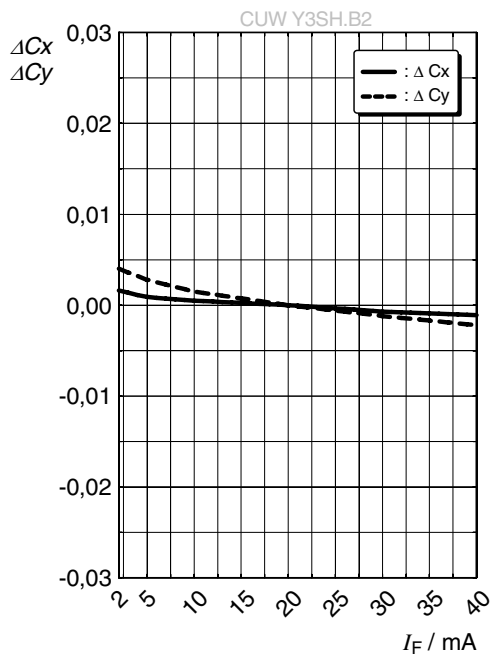

Forward Voltage ⁶⁾

$$\Delta V_F = V_F - V_F(25\text{ }^\circ\text{C}) = f(T_j); I_F = 20\text{ mA}$$

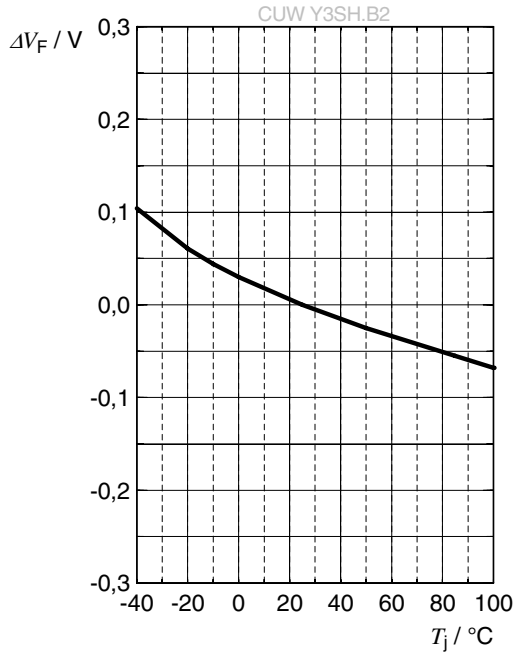

Relative Luminous Flux ⁶⁾

$$\Phi_V / \Phi_V(25\text{ }^\circ\text{C}) = f(T_j); I_F = 20\text{ mA}$$

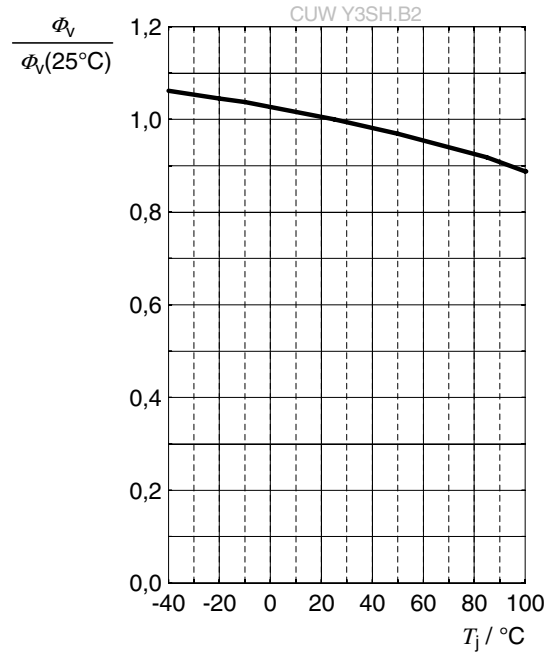

Chromaticity Coordinate Shift ⁶⁾

$$\Delta C_x, \Delta C_y = f(T_j); I_F = 20\text{ mA}$$

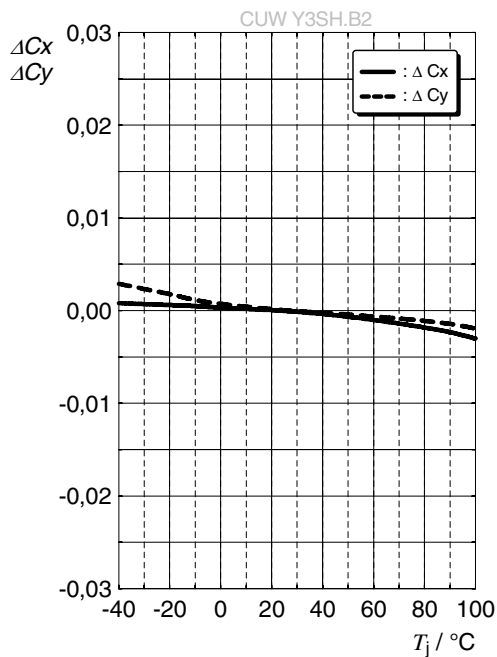

Max. Permissible Forward Current ⁵⁾

$I_F = f(T)$

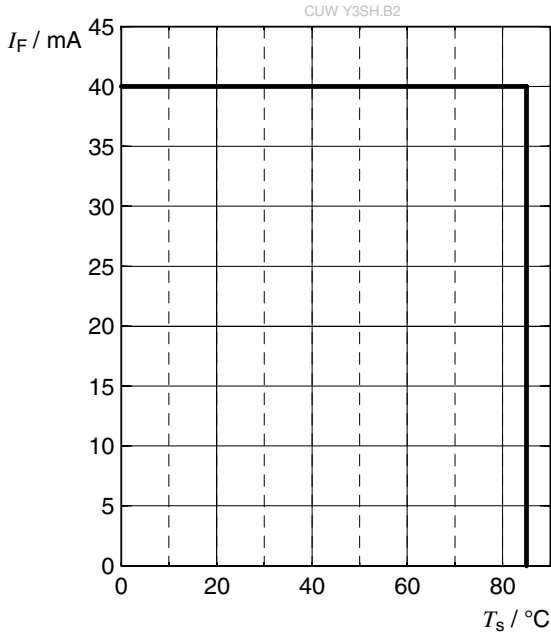

Permissible Pulse Handling Capability

$I_F = f(t_p)$; D: Duty cycle

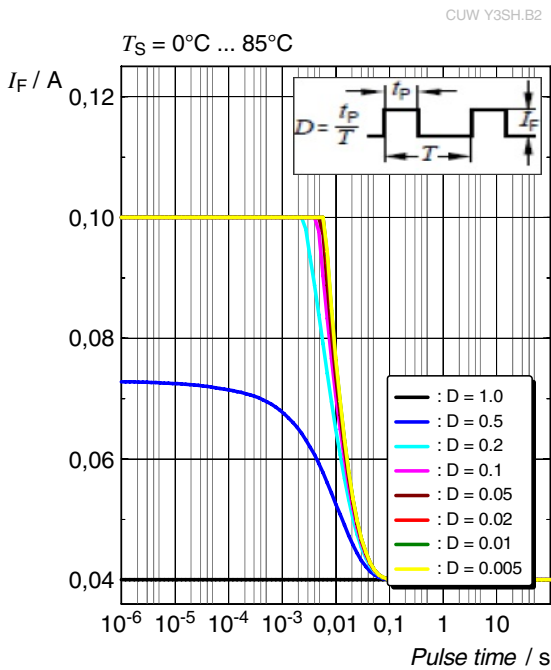

Dimensional Drawing ⁸⁾

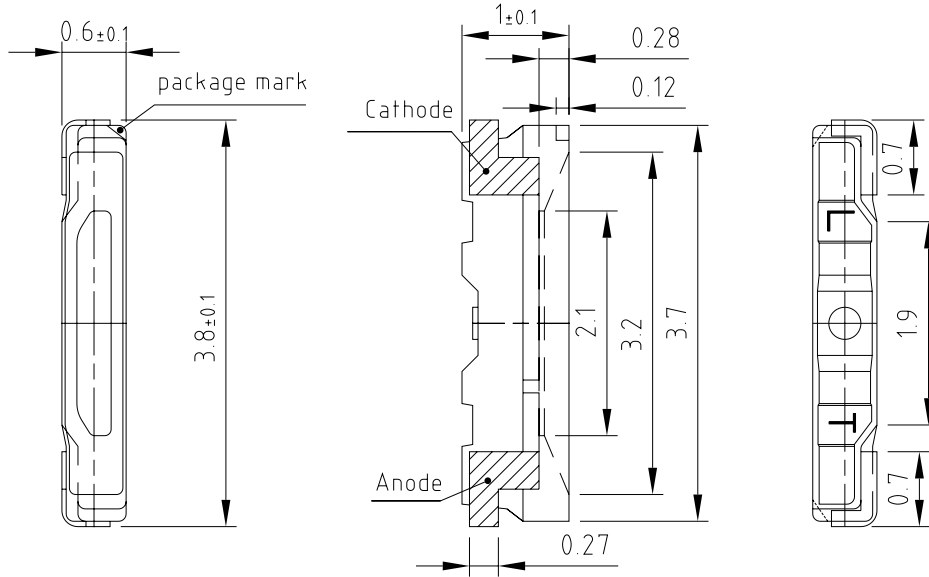

General tolerance ± 0.1
lead finish Ag 

C67062-A0392-A1-01

Further Information:

Approximate Weight: 4.0 mg

Corrosion test: Class: 1B
Test condition: 25°C / 75 % RH / 200ppb SO₂, 200ppb NO₂, 10ppb H₂S, 10ppb Cl₂ / 21 days (EN 60068-2-60 (Method 4))

Recommended Solder Pad ⁸⁾

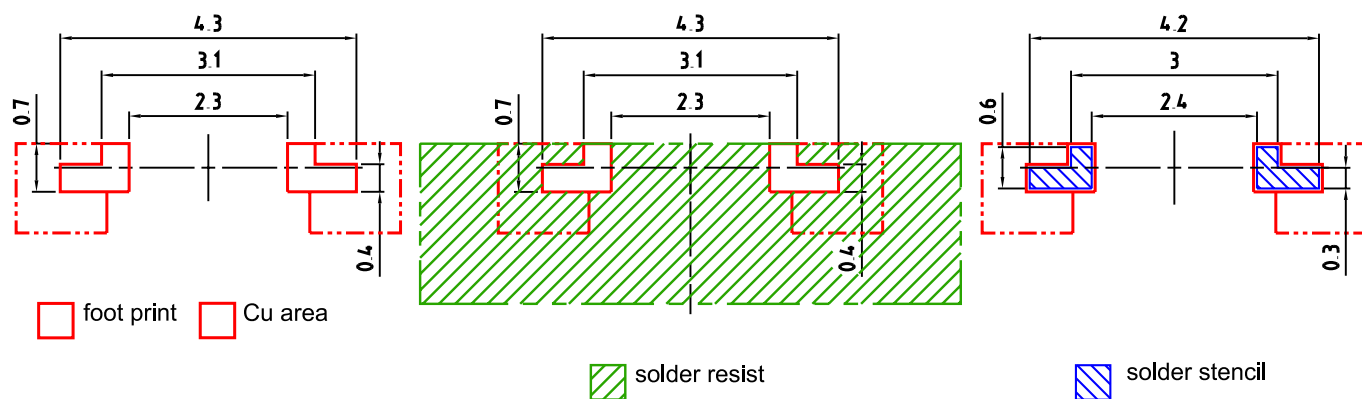

E062.3010.183 -02

For superior solder joint connectivity results we recommend soldering under standard nitrogen atmosphere. Package not suitable for ultra sonic cleaning.

Reflow Soldering Profile

Product complies to MSL Level 3 acc. to JEDEC J-STD-020E

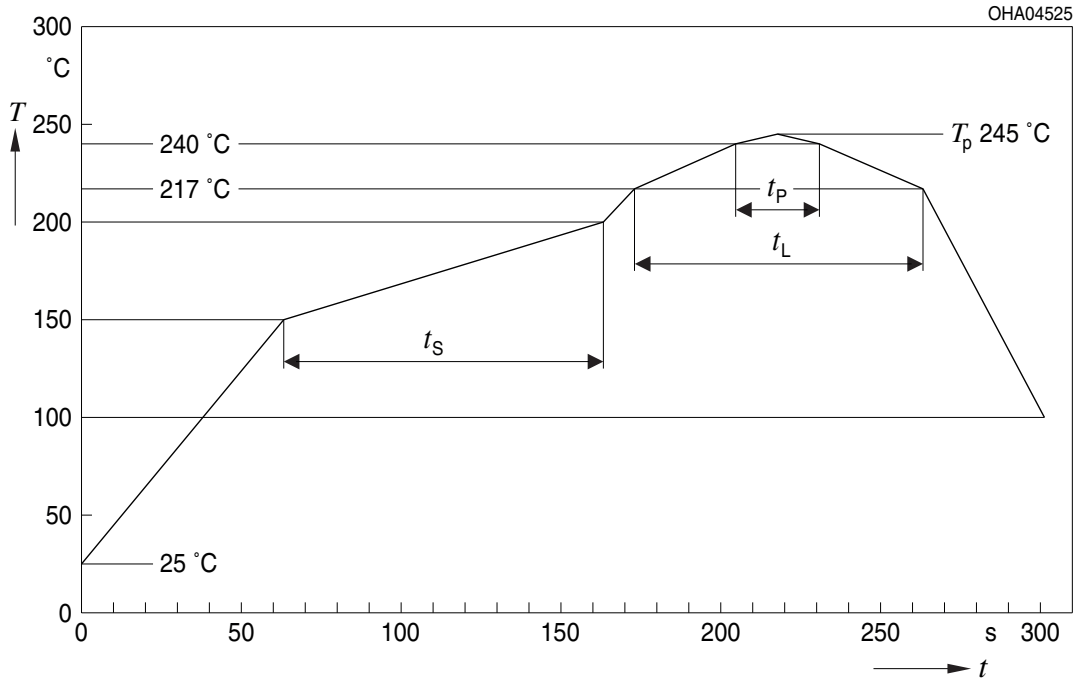

Profile Feature	Symbol	Pb-Free (SnAgCu) Assembly			Unit
		Minimum	Recommendation	Maximum	
Ramp-up rate to preheat ^{*)} 25 °C to 150 °C			2	3	K/s
Time t_s T_{Smin} to T_{Smax}	t_s	60	100	120	s
Ramp-up rate to peak ^{*)} T_{Smax} to T_p			2	3	K/s
Liquidus temperature	T_L		217		°C
Time above liquidus temperature	t_L		80	100	s
Peak temperature	T_p		245	260	°C
Time within 5 °C of the specified peak temperature $T_p - 5$ K	t_p	10	20	30	s
Ramp-down rate* T_p to 100 °C			3	6	K/s
Time 25 °C to T_p				480	s

All temperatures refer to the center of the package, measured on the top of the component
^{*)} slope calculation DT/Dt : Dt max. 5 s; fulfillment for the whole T-range

Taping ⁸⁾

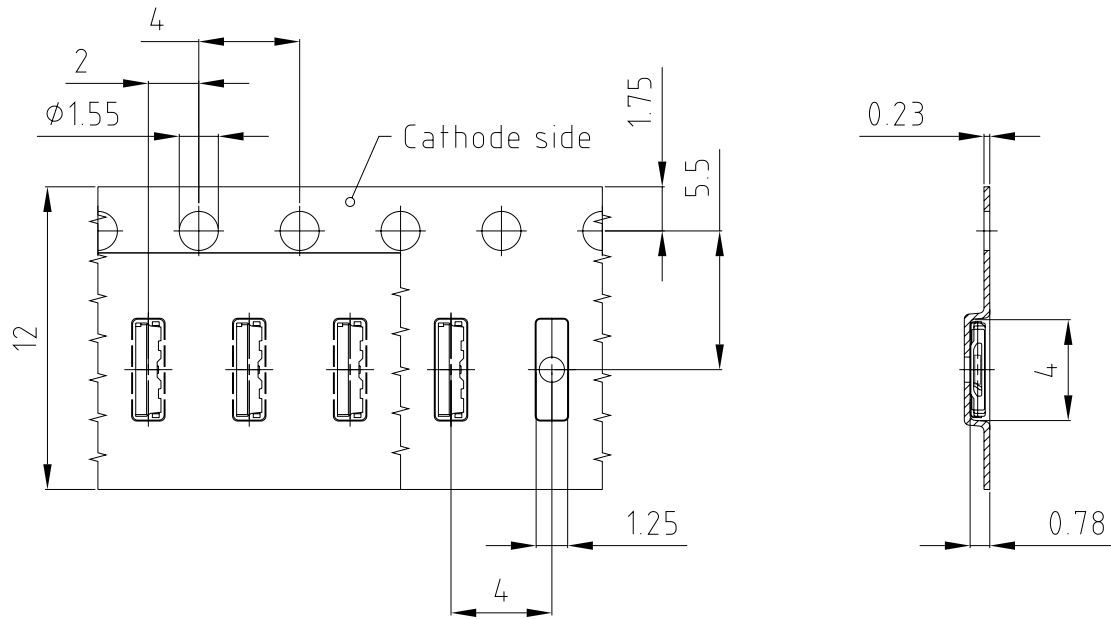

C67062-A0392-B1-02

Tape and Reel ⁹⁾

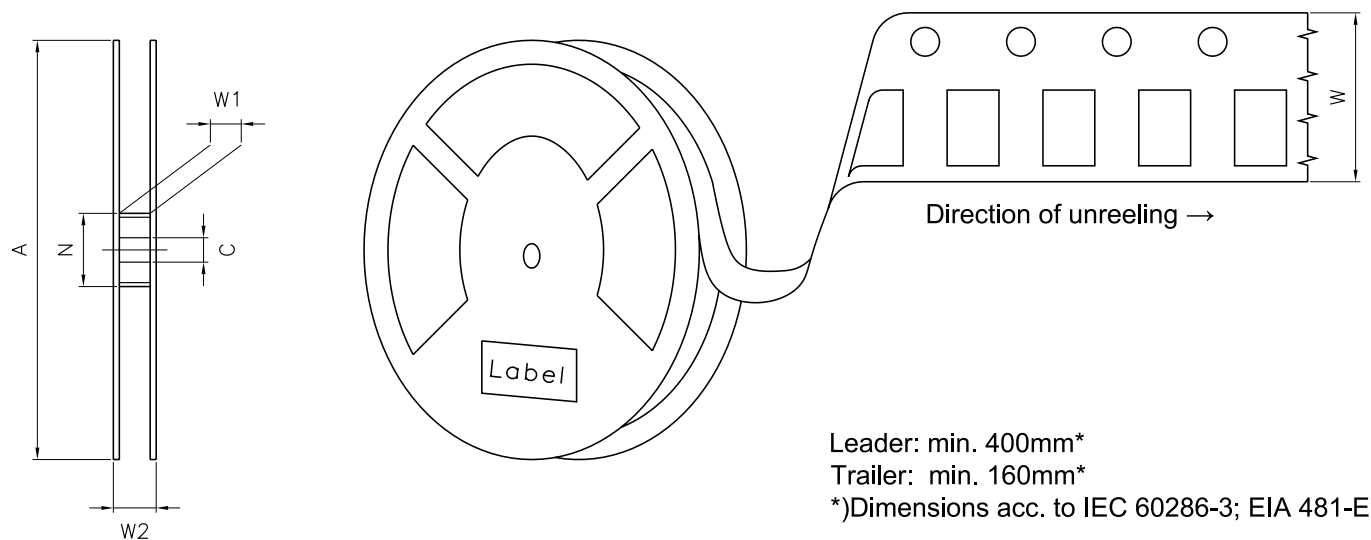

Reel Dimensions

A	W	N _{min}	W ₁	W _{2max}	Pieces per PU
180 mm	12 + 0.3 / - 0.1 mm	60 mm	12.4 + 2 mm	18.4 mm	3000

Barcode-Product-Label (BPL)

OSRAM LX XXXX BIN1: XX-XX-X-XXX-X

RoHS Compliant

(6P) BATCH NO: 1234567890

(1T) LOT NO: 1234567890 (9D) D/C: 1234

(X) PROD NO: 123456789 (Q) QTY: 9999 (G) GROUP: XX-XX-X-X

ML Temp ST
X XXX °C X

Pack: RXX
DEMY XXX
X_X123_1234.1234 X

OHA04563

Dry Packing Process and Materials ⁸⁾

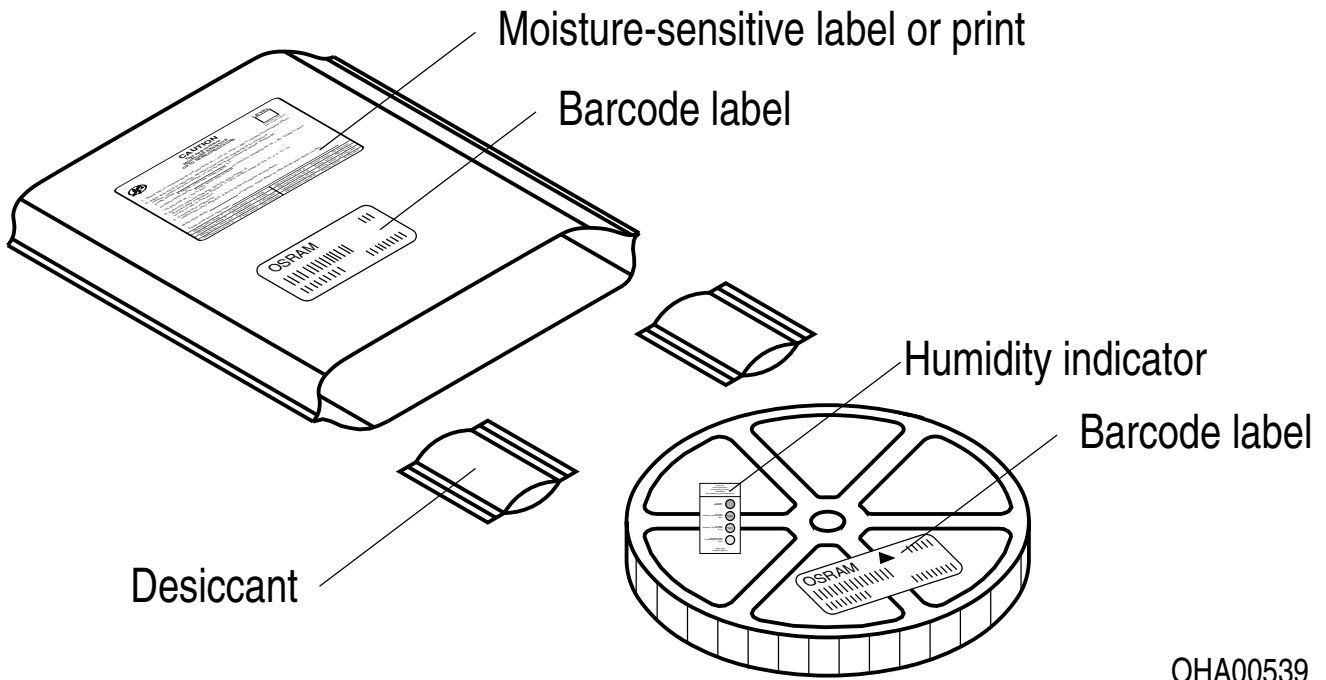

Moisture-sensitive product is packed in a dry bag containing desiccant and a humidity card according JEDEC-STD-033.

Notes

The evaluation of eye safety occurs according to the standard IEC 62471:2006 (photo biological safety of lamps and lamp systems). Within the risk grouping system of this IEC standard, the device specified in this data sheet fall into the class **exempt group (exposure time 10000 s)**. Under real circumstances (for exposure time, conditions of the eye pupils, observation distance), it is assumed that no endangerment to the eye exists from these devices. As a matter of principle, however, it should be mentioned that intense light sources have a high secondary exposure potential due to their blinding effect. When looking at bright light sources (e.g. headlights), temporary reduction in visual acuity and afterimages can occur, leading to irritation, annoyance, visual impairment, and even accidents, depending on the situation.

Subcomponents of this device contain, in addition to other substances, metal filled materials including silver. Metal filled materials can be affected by environments that contain traces of aggressive substances. Therefore, we recommend that customers minimize device exposure to aggressive substances during storage, production, and use. Devices that showed visible discoloration when tested using the described tests above did show no performance deviations within failure limits during the stated test duration. Respective failure limits are described in the IEC60810.

For further application related information please visit <https://ams-osram.com/support/application-notes>

Disclaimer

Attention please!

The information describes the type of component and shall not be considered as assured characteristics. Terms of delivery and rights to change design reserved. Due to technical requirements components may contain dangerous substances.

For information on the types in question please contact our Sales Organization.

If printed or downloaded, please find the latest version on our website.

Packing

Please use the recycling operators known to you. We can also help you – get in touch with your nearest sales office. By agreement we will take packing material back, if it is sorted. You must bear the costs of transport. For packing material that is returned to us unsorted or which we are not obliged to accept, we shall have to invoice you for any costs incurred.

Product and functional safety devices/applications or medical devices/applications

Our components are not developed, constructed or tested for the application as safety relevant component or for the application in medical devices.

Our products are not qualified at module and system level for such application.

In case buyer – or customer supplied by buyer – considers using our components in product safety devices/ applications or medical devices/applications, buyer and/or customer has to inform our local sales partner immediately and we and buyer and /or customer will analyze and coordinate the customer-specific request between us and buyer and/or customer.

Glossary

- 1) **Brightness:** Brightness groups are tested at a current pulse duration of 25 ms and a tolerance of $\pm 11\%$.
- 2) **Reverse Operation:** This product is intended to be operated applying a forward current within the specified range. Applying any continuous reverse bias or forward bias below the voltage range of light emission shall be avoided because it may cause migration which can change the electro-optical characteristics or damage the LED.
- 3) **Chromaticity coordinate groups:** Chromaticity coordinate groups are tested at a current pulse duration of 25 ms and a tolerance of ± 0.01 .
- 4) **Forward Voltage:** Forward voltages are tested at a current pulse duration of 1 ms and a tolerance of $\pm 0.1\text{ V}$.
- 5) **Thermal Resistance:** $R_{th\ max}$ is based on statistic values (6σ) used for Derating.
- 6) **Typical Values:** Due to the special conditions of the manufacturing processes of semiconductor devices, the typical data or calculated correlations of technical parameters can only reflect statistical figures. These do not necessarily correspond to the actual parameters of each single product, which could differ from the typical data and calculated correlations or the typical characteristic line. If requested, e.g. because of technical improvements, these typ. data will be changed without any further notice.
- 7) **Characteristic curve:** In the range where the line of the graph is broken, you must expect higher differences between single devices within one packing unit.
- 8) **Tolerance of Measure:** Unless otherwise noted in drawing, tolerances are specified with ± 0.1 and dimensions are specified in mm.
- 9) **Tape and Reel:** All dimensions and tolerances are specified acc. IEC 60286-3 and specified in mm.

Revision History

Version	Date	Change
1.0	2021-01-15	Initial Version
1.1	2024-01-09	New Layout Applications Taping



EU RoHS and China RoHS compliant product

此产品符合欧盟 RoHS 指令的要求；
按照中国的相关法规和标准，
不含有毒有害物质或元素。

Published by ams-OSRAM AG

Tobelbader Strasse 30, 8141 Premstaetten, Austria

Phone +43 3136 500-0

ams-osram.com

© All rights reserved

am 

OSRAM