

NPN Silicon Epitaxial Transistor

for switching and amplifier applications

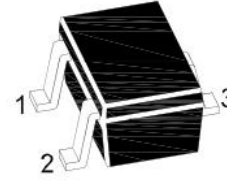

1.Base 2.Emitter 3.Collector
SOT-523 Plastic Package

Absolute Maximum Ratings ($T_a = 25\text{ }^\circ\text{C}$)

Parameter	Symbol	Value	Unit
Collector Base Voltage	V_{CBO}	BC846T: 80 BC847T, BC850T: 50 BC848T, BC849T: 30	V
Collector Emitter Voltage		V_{CEO}	BC846T: 65 BC847T, BC850T: 45 BC848T, BC849T: 30
Emitter Base Voltage			V_{EBO}
Collector Current	I_C		
Peak Collector Current	I_{CM}	200	mA
Power Dissipation	P_{tot}	150	mW
Junction Temperature	T_j	150	$^\circ\text{C}$
Storage Temperature Range	T_{stg}	- 65 to + 150	$^\circ\text{C}$

Characteristics at $T_a = 25\text{ }^\circ\text{C}$

Parameter	Symbol	Min.	Typ.	Max.	Unit	
DC Current Gain at $V_{CE} = 5\text{ V}$, $I_C = 2\text{ mA}$	Current Gain Group A	h_{FE}	110	-	220	-
	B	h_{FE}	200	-	450	-
	C	h_{FE}	420	-	800	-
Collector Base Cutoff Current at $V_{CB} = 30\text{ V}$	I_{CBO}	-	-	15	nA	
Collector Emitter Saturation Voltage at $I_C = 10\text{ mA}$, $I_B = 0.5\text{ mA}$ at $I_C = 100\text{ mA}$, $I_B = 5\text{ mA}$	$V_{CE(sat)}$	-	-	250	mV	
	$V_{CE(sat)}$	-	-	600	mV	
Base Emitter On Voltage at $V_{CE} = 5\text{ V}$, $I_C = 2\text{ mA}$ at $V_{CE} = 5\text{ V}$, $I_C = 10\text{ mA}$	$V_{BE(on)}$	580	-	700	mV	
	$V_{BE(on)}$	-	-	720	mV	
Transition Frequency at $V_{CE} = 5\text{ V}$, $I_C = 10\text{ mA}$, $f = 100\text{ MHz}$	f_T	-	300	-	MHz	
Output Capacitance at $V_{CB} = 10\text{ V}$, $f = 1\text{ MHz}$	C_{ob}	-	-	6	pF	

MARKING CODE

TYPE	846AT	846BT	846CT	847AT	847BT	847CT	848AT	848BT	848CT
MARKING	1A	1B	1C	1E	1F	1G	1J	1K	1L
TYPE	849AT	849BT	849CT	850AT	850BT	850CT			
MARKING	2A	2B	2C	2E	2F	2G			

STATIC CHARACTERISTIC

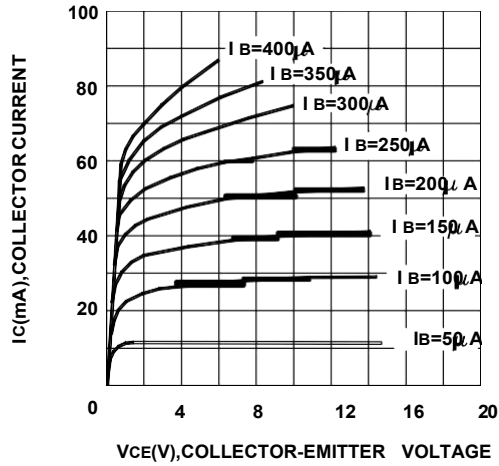

BASE-EMITTER ON VOLTAGE

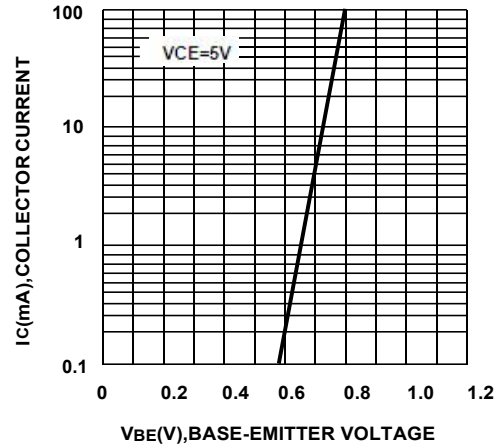

DC CURRENT GAIN

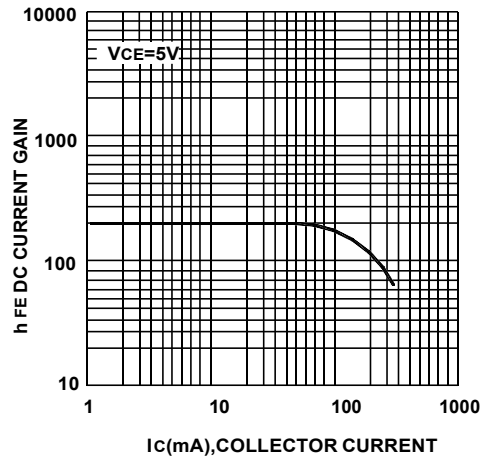

CURRENT GAIN BANDWIDTH PRODUCT

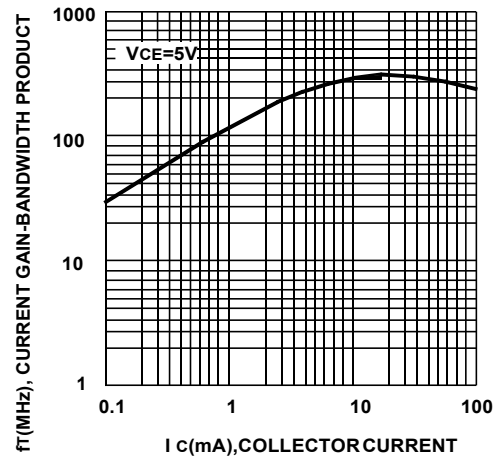

BASE-EMITTER SATURATION VOLTAGE
COLLECTOR-EMITTER SATURATION VOLTAGE

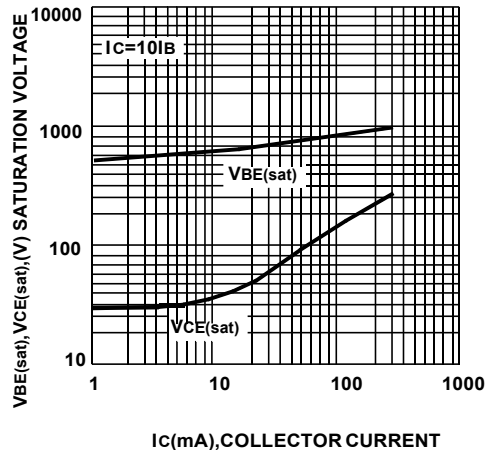

COLLECTOR OUTPUT CAPACITANCE

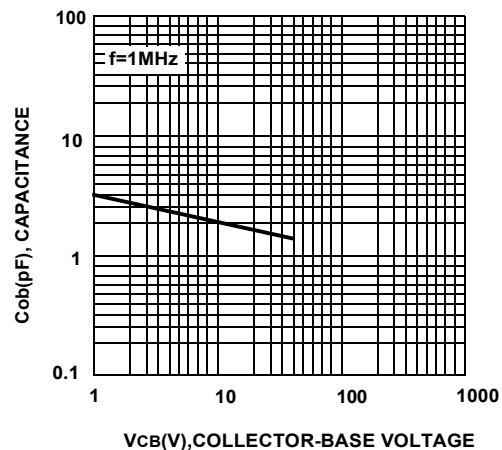

PACKAGE OUTLINE

Plastic surface mounted package; 3 leads

SOT-523

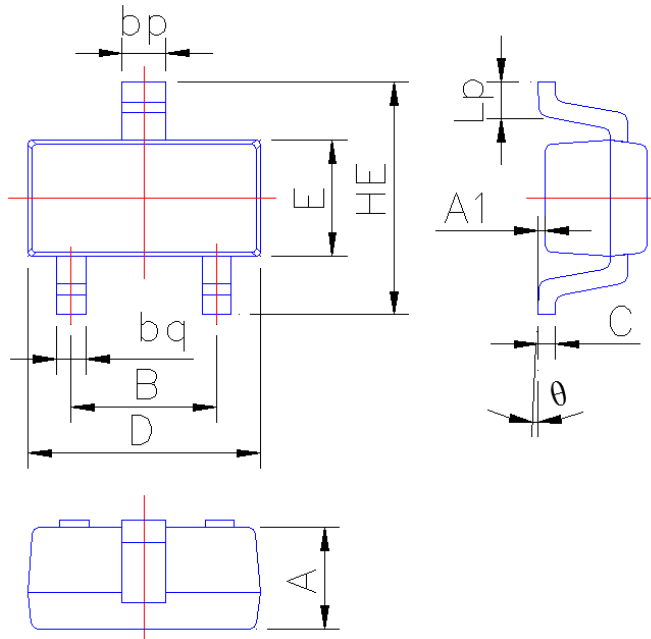

Symbol	Dimension in Millimeters	
	Min	Max
A	0.60	0.80
A1	0.010	0.100
B	0.95	1.05
bp	0.26	0.40
bq	0.16	0.30
C	0.09	0.15
D	1.50	1.70
E	0.70	0.85
HE	1.45	1.75
Lp	0.16	0.36
θ	0°	5°