

Description

The SMFJ series is designed specifically to protect sensitive electronic equipment from voltage transients induced by lightning and other transient voltage events. SOD-123FL package is 50% smaller in footprint when compare to SMA package and delivering low height profile (1.1mm) in the industry.

Features

- I Fast response time
- I Built-in strain relief
- I Low incremental surge resistance
- I Matte tin lead-free Plated
- I Halogen free and RoHS compliant
- I For surface mounted applications to optimize board space
- I Compatible with industrial standard package SOD-123FL
- I 200W peak pulse power capability with at 10/1000µs waveform, repetition rate (duty cycle): 0.01%
- I High temperature soldering: 260°C/10 seconds at terminals

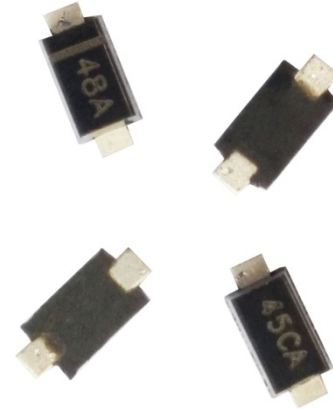

Electrical symbol

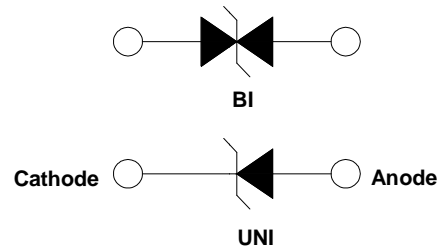

Part Number Code

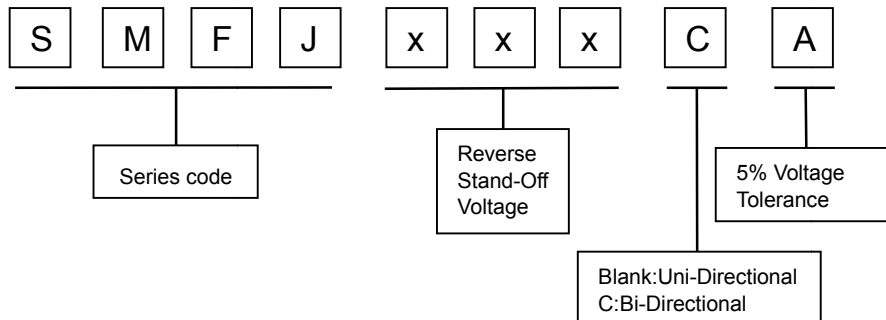

Mechanical Characteristics

Rating	Symbol	Value	Units
Peak Pulse Power Dissipation at $T_A=25^\circ\text{C}$ by 10/1000µs(Fig.2) (Note1)	P_{PP}	200	W
Power Dissipation on Infinite Heat Sink at $T_L=75^\circ\text{C}$ (Fig.6)	P_D	1.0	W
Peak Forward Surge Current, 8.3ms Single Half Sine Wave (Note 2)	I_{FSM}	30	A
Operating Temperature Range	T_J	-55 to 150	°C
Storage Temperature Range	T_{STG}	-55 to 150	°C

Notes:

1. Non-repetitive current pulse , per Fig. 4 and derated above $T_A = 25^\circ\text{C}$ per Fig. 3.
2. Measured on 8.3ms single half sine wave or equivalent square wave for unidirectional device only.



Electrical Characteristics

Type Number		Marking		Reverse Stand-Off Voltage	Breakdown Voltage		Test Current	Max. Clamping Voltage 10/1000µs	Max. Peak Pulse Current 10/1000µs	Reverse Leakage
					V _{BR} @I _T					
					V _{RWM}	I _T				
UNI	BI	UNI	BI	V	Min	Max	mA	V	A	µA
SMFJ5.0A	SMFJ5.0CA	5.0A	5.0CA	5.0	6.40	7.07	10	9.6	20.8	400
SMFJ6.0A	SMFJ6.0CA	6.0A	6.0CA	6.0	6.67	7.37	10	10.3	19.4	400
SMFJ6.5A	SMFJ6.5CA	6.5A	6.5CA	6.5	7.22	7.98	10	11.2	17.8	50
SMFJ7.0A	SMFJ7.0CA	7.0A	7.0CA	7.0	7.78	8.60	10	12.0	16.6	30
SMFJ7.5A	SMFJ7.5CA	7.5A	7.5CA	7.5	8.33	9.21	1	12.9	15.5	30
SMFJ8.0A	SMFJ8.0CA	8.0A	8.0CA	8.0	8.89	9.83	1	13.6	14.7	10
SMFJ8.5A	SMFJ8.5CA	8.5A	8.5CA	8.5	9.44	10.4	1	14.4	13.9	5
SMFJ9.0A	SMFJ9.0CA	9.0A	9.0CA	9.0	10.0	11.1	1	15.4	13.0	3
SMFJ10A	SMFJ10CA	10A	10CA	10.0	11.1	12.3	1	17.0	11.7	1
SMFJ11A	SMFJ11CA	11A	11CA	11.0	12.2	13.5	1	18.2	11.0	1
SMFJ12A	SMFJ12CA	12A	12CA	12.0	13.3	14.7	1	19.9	10.0	1
SMFJ13A	SMFJ13CA	13A	13CA	13.0	14.4	15.9	1	21.5	9.3	1
SMFJ14A	SMFJ14CA	14A	14CA	14.0	15.6	17.2	1	23.2	8.6	1
SMFJ15A	SMFJ15CA	15A	15CA	15.0	16.7	18.5	1	24.4	8.2	1
SMFJ16A	SMFJ16CA	16A	16CA	16.0	17.8	19.7	1	26.0	7.7	1
SMFJ17A	SMFJ17CA	17A	17CA	17.0	18.9	20.9	1	27.6	7.2	1
SMFJ18A	SMFJ18CA	18A	18CA	18.0	20.0	22.1	1	29.2	6.8	1
SMFJ20A	SMFJ20CA	20A	20CA	20.0	22.2	24.5	1	32.4	6.1	1
SMFJ22A	SMFJ22CA	22A	22CA	22.0	24.4	26.9	1	35.5	5.6	1
SMFJ24A	SMFJ24CA	24A	24CA	24.0	26.7	29.5	1	38.9	5.1	1
SMFJ26A	SMFJ26CA	26A	26CA	26.0	28.9	31.9	1	42.1	4.7	1
SMFJ28A	SMFJ28CA	28A	28CA	28.0	31.1	34.4	1	45.4	4.4	1
SMFJ30A	SMFJ30CA	30A	30CA	30.0	33.3	36.8	1	48.4	4.1	1
SMFJ33A	SMFJ33CA	33A	33CA	33.0	36.7	40.6	1	53.3	3.7	1
SMFJ36A	SMFJ36CA	36A	36CA	36.0	40.0	44.2	1	58.1	3.4	1
SMFJ40A	SMFJ40CA	40A	40CA	40.0	44.4	49.1	1	64.5	3.1	1
SMFJ43A	SMFJ43CA	43A	43CA	43.0	47.8	52.8	1	69.4	2.9	1
SMFJ45A	SMFJ45CA	45A	45CA	45.0	50.0	55.3	1	72.7	2.7	1
SMFJ48A	SMFJ48CA	48A	48CA	48.0	53.3	58.9	1	77.4	2.6	1
SMFJ51A	SMFJ51CA	51A	51CA	51.0	56.7	62.7	1	82.4	2.4	1
SMFJ54A	SMFJ54CA	54A	54CA	54.0	60.0	66.3	1	87.1	2.3	1
SMFJ58A	SMFJ58CA	58A	58CA	58.0	64.4	71.2	1	93.6	2.1	1
SMFJ60A	SMFJ60CA	60A	60CA	60.0	66.7	73.7	1	96.8	2.0	1
SMFJ64A	SMFJ64CA	64A	64CA	64.0	71.1	78.6	1	103.0	1.9	1
SMFJ70A	SMFJ70CA	70A	70CA	70.0	77.8	86.0	1	113.0	1.7	1
SMFJ75A	SMFJ75CA	75A	75CA	75.0	83.3	92.1	1	121.0	1.6	1



Electrical Characteristics

Type Number		Marking		Reverse Stand-Off Voltage	Breakdown Voltage		Test Current	Max. Clamping Voltage 10/1000µs	Max. Peak Pulse Current 10/1000µs	Reverse Leakage
					$V_{BR} @ I_T$					
				V_{RWM}	Min	Max	I_T	$V_C @ I_{PP}$	I_{PP}	$I_R @ V_{RWM}$
UNI	BI	UNI	BI	V	V	V	mA	V	A	µA
SMFJ78A	SMFJ78CA	78A	78CA	78.0	86.7	95.8	1	126.0	1.5	1
SMFJ85A	SMFJ85CA	85A	85CA	85.0	94.4	104.0	1	137.0	1.4	1
SMFJ90A	SMFJ90CA	90A	90CA	90.0	100.0	111.0	1	146.0	1.3	1
SMFJ100A	SMFJ100CA	100A	100CA	100.0	111.0	123.0	1	162.0	1.2	1
SMFJ110A	SMFJ110CA	110A	110CA	110.0	122.0	135.0	1	177.0	1.1	1
SMFJ120A	SMFJ120CA	120A	120CA	120.0	133.0	147.0	1	193.0	1.0	1
SMFJ130A	SMFJ130CA	130A	130CA	130.0	144.0	159.0	1	209.0	0.9	1
SMFJ150A	SMFJ150CA	150A	150CA	150.0	167.0	185.0	1	243.0	0.8	1
SMFJ160A	SMFJ160CA	160A	160CA	160.0	178.0	197.0	1	259.0	0.7	1
SMFJ170A	SMFJ170CA	170A	170CA	170.0	189.0	209.0	1	275.0	0.7	1
SMFJ180A	SMFJ180CA	180A	180CA	180.0	201.0	222.0	1	292.0	0.7	1
SMFJ190A	SMFJ190CA	190A	190CA	190.0	209.0	243.0	1	308.0	0.6	1
SMFJ200A	SMFJ200CA	200A	200CA	200.0	224.0	247.0	1	324.0	0.6	1
SMFJ220A	SMFJ220CA	220A	220CA	220.0	246.0	272.0	1	356.0	0.5	1

Notes: For bidirectional type having V_{RWM} of 10V and less, the I_R limit is double.

I-V Curve Characteristics

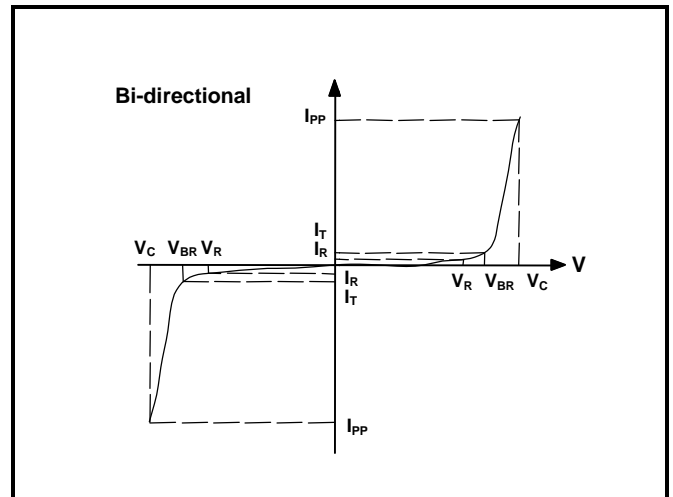
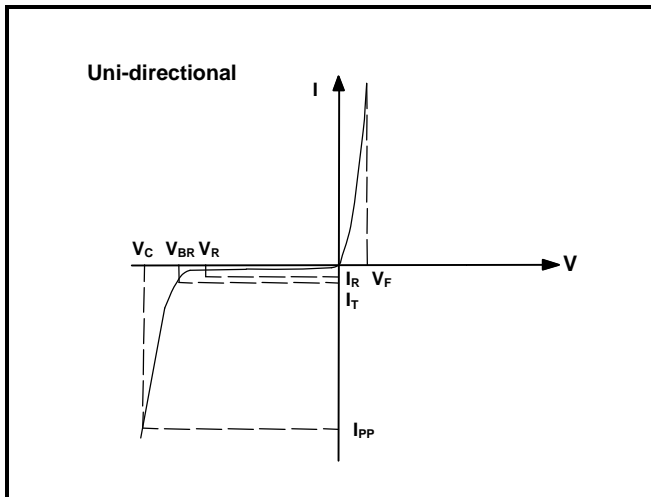

P_{PPM} Peak Pulse Power Dissipation -- Max power dissipation

V_R Stand-off Voltage -- Maximum voltage that can be applied to the TVS without operation

V_{BR} Breakdown Voltage -- Maximum voltage that flows through the TVS at a specified test current (I_T)

V_C Clamping Voltage -- Peak voltage measured across the TVS at a specified I_{ppm} (peak impulse current)

I_R Reverse Leakage Current -- Current measured at V_R

V_F Forward Voltage Drop for Uni-directional



Ratings and Characteristic Curves ($T_A=25^\circ\text{C}$ unless otherwise noted)

Figure 1 - TVS Transients Clamping Waveform

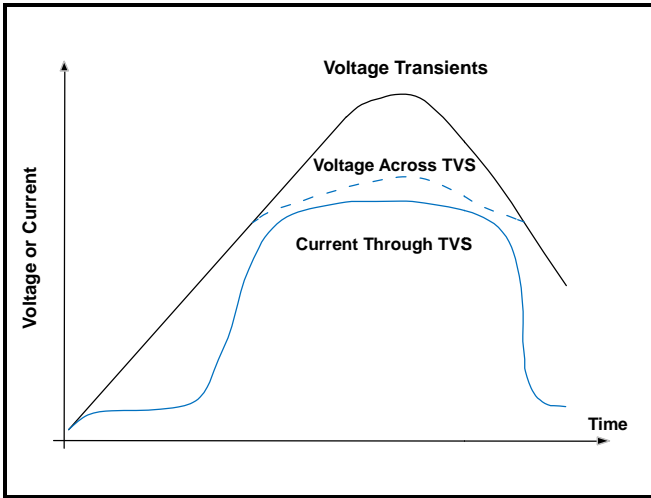

Figure 2 - Peak Pulse Power Rating Curve

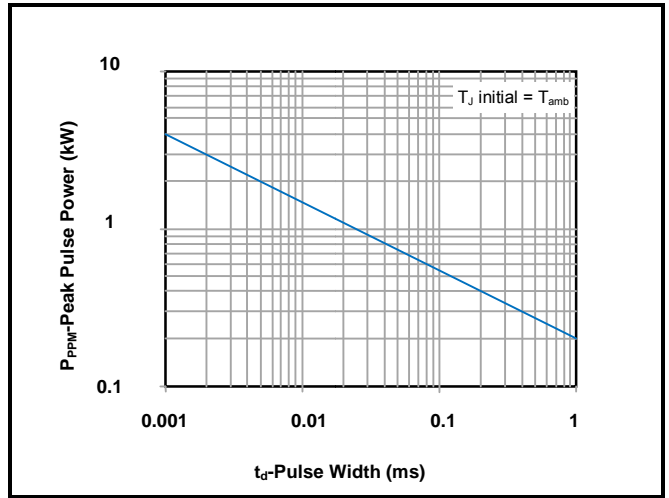

Figure 3 - Pulse Derating Curve

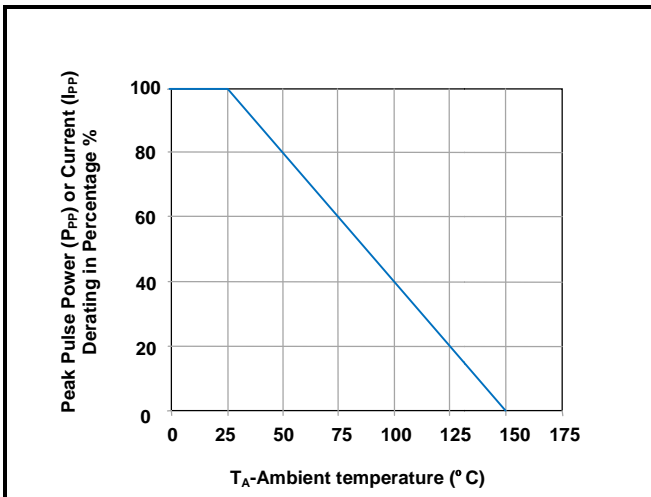

Figure 4 - Pulse Waveform

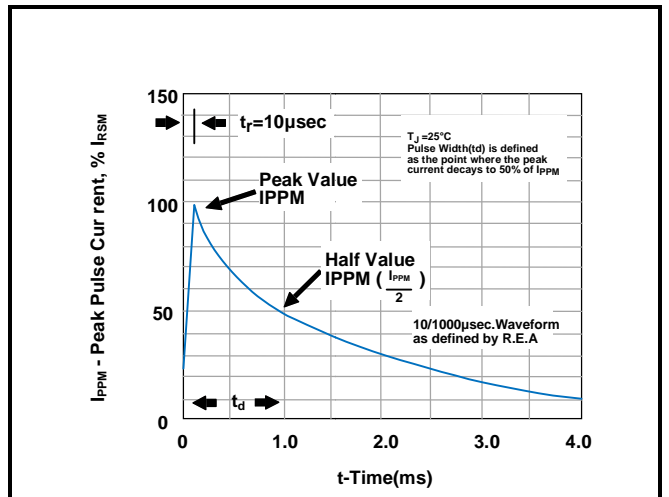

Figure 5 - Typical Junction Capacitance

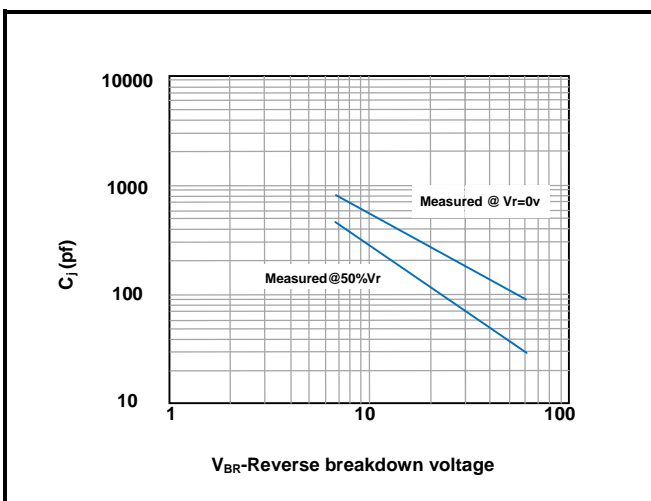

Figure 6 - Steady State Power Derating Curve

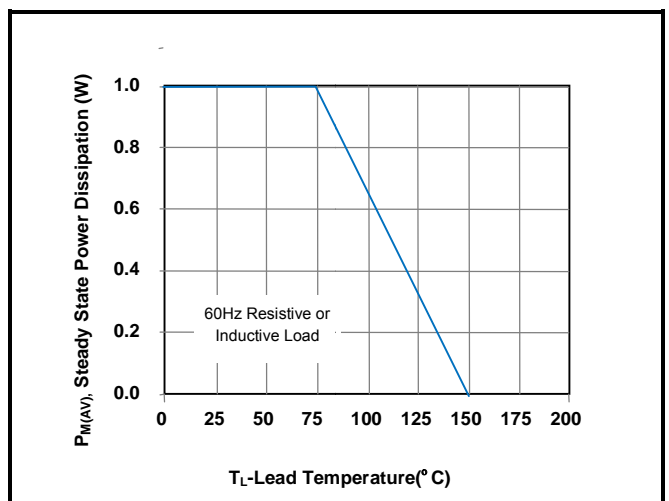
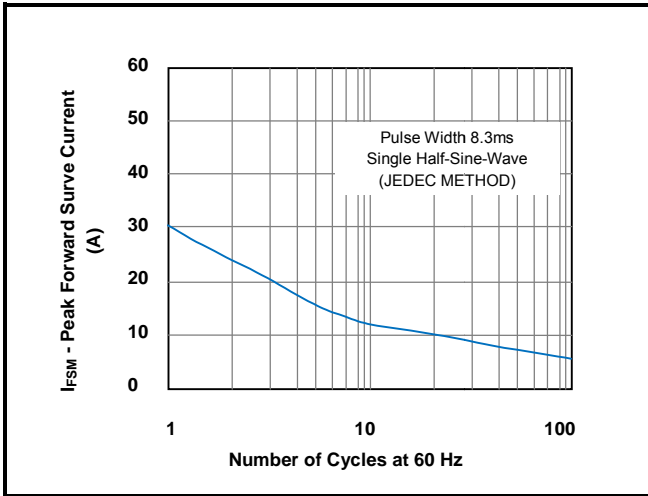
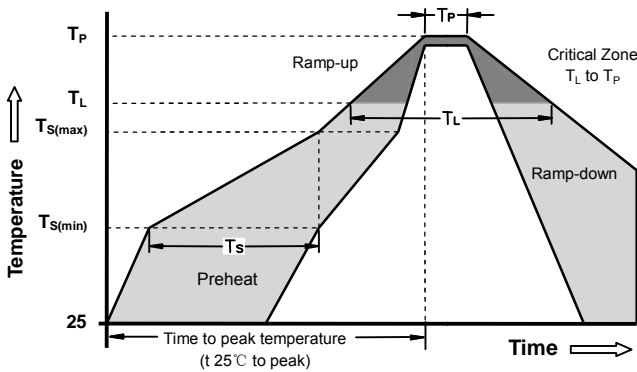

Figure 7 - Maximum Non-Repetitive Surge Current



Soldering Parameters - Reflow Soldering (Surface Mount Devices)



Reflow Condition		Pb - Free assembly
Pre Heat	-Temperature Min ($T_{s(min)}$)	150°C
	-Temperature Max ($T_{s(max)}$)	200°C
	- Time (min to max) (t_s)	60 -180 Seconds
Average ramp up rate (Liquids Temp T_L) to peak		3°C/second max
$T_{s(max)}$ to T_L - Ramp-up Rate		3°C/second max
Reflow	- Temperature (T_L) (Liquids)	217°C
	- Time (min to max) (t_s)	60 -150 Seconds
Peak Temperature (T_P)		260 +0/-5°C
Time within 5°C of actual peak Temperature (t_p)		20 - 40 Seconds
Ramp-down Rate		6°C/second max
Time 25°C to peak Temperature (T_P)		8 minutes Max
Do not exceed		260°C

Part Marking System

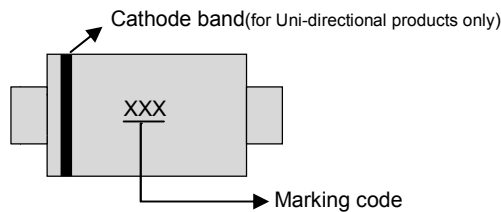

Dimensions

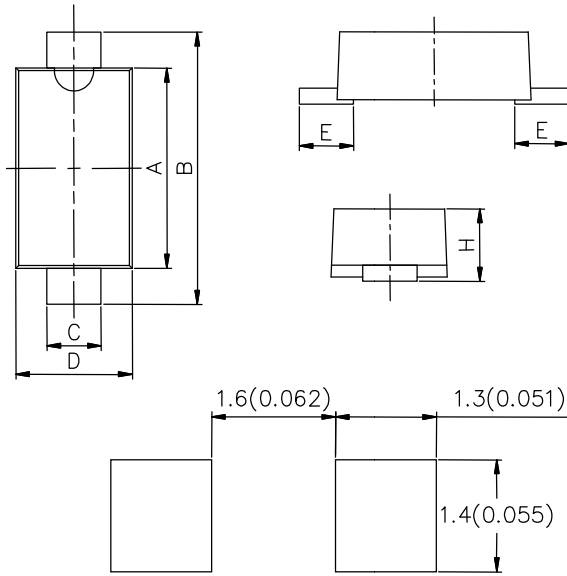

DIM	Millimeters		Inches	
	Min	Max	Min	Max
A	2.30	2.90	0.091	0.114
B	3.30	3.90	0.130	0.154
C	0.50	1.20	0.020	0.047
D	1.40	1.95	0.055	0.077
E	0.35	0.85	0.014	0.033
H	0.90	1.40	0.035	0.055

Taping and Reel Specifications

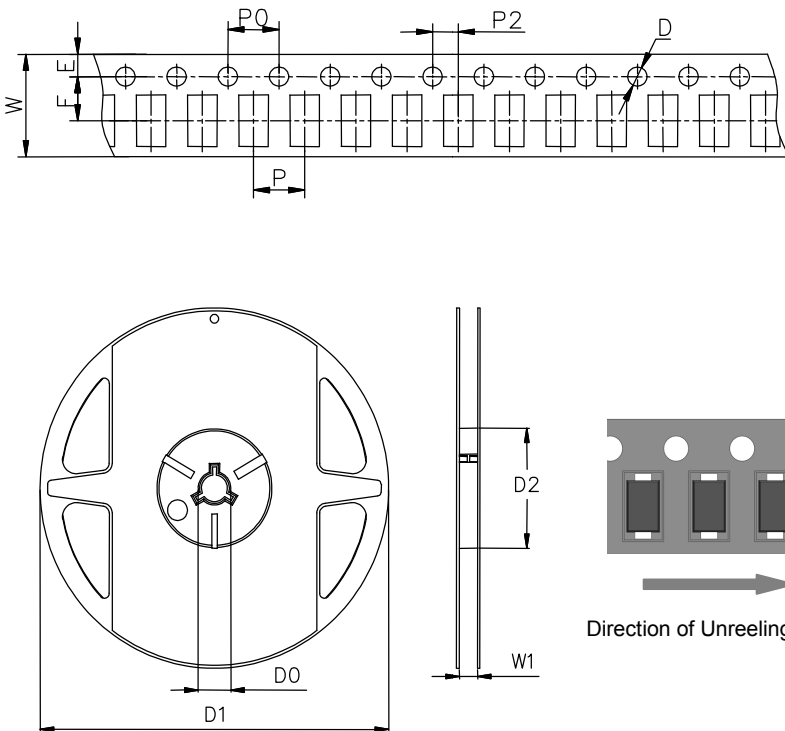

Symbol	Millimeters	Inches
W	8±0.1	0.315±0.004
P	4±0.1	0.157±0.004
F	3.44±0.1	0.135±0.004
E	1.75±0.1	0.069±0.004
D	1.5+0.1/-0.0	0.059+0.004/-0.0
P0	4±0.1	0.157±0.004
P2	2±0.1	0.079±0.004
D0	16.7±0.15	0.657±0.006
D1	178±2	7.007±0.079
D2	59.6+1/-2	2.346+0.039/-0.079
W1	9.3±0.2	0.366±0.008

Part Number	Component package	Quantity	Packaging option	Packaging specification
SMFJXXXXA/CA	SOD-123FL	3000	Tape&Reel-8mm/7"tape	EIA STD RS-481

