

## FEATURES

- Fast switching
- 100% avalanche tested
- Improved dv/dt capability

## APPLICATIONS

- Switch Mode Power Supply (SMPS)
- Uninterruptible Power Supply (UPS)
- Power Factor Correction (PFC)

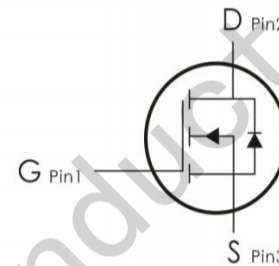
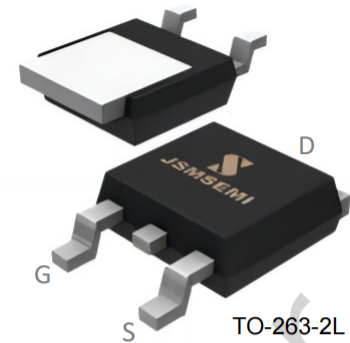

Device Marking and Package Information		
Device	Package	Marking
NTB25P06T4G	TO-263	NTB25P06G

Absolute Maximum Ratings $T_C = 25^\circ\text{C}$ , unless otherwise noted			
Parameter	Symbol	Value	Unit
		TO-263	
Drain-Source Voltage ( $V_{GS} = 0\text{V}$ )	$V_{DSS}$	-60	V
Continuous Drain Current	$I_D$	-35	A
Pulsed Drain Current (note1)	$I_{DM}$	-140	A
Gate-Source Voltage	$V_{GSS}$	$\pm 20$	V
Single Pulse Avalanche Energy (note2)	$E_{AS}$	250	mJ
Avalanche Current (note1)	$I_{AR}$	-50	A
Repetitive Avalanche Energy (note1)	$E_{AR}$	36	mJ
Power Dissipation ( $T_C = 25^\circ\text{C}$ )	$P_D$	110	W
Operating Junction and Storage Temperature Range	$T_J, T_{stg}$	-55~+150	$^\circ\text{C}$

Thermal Resistance			
Parameter	Symbol	Value	Unit
		TO-263	
Thermal Resistance, Junction-to-Case	$R_{thJC}$	1.14	KW
Thermal Resistance, Junction-to-Ambient	$R_{thJA}$	60	

<b>Specifications</b> $T_J = 25^\circ\text{C}$ , unless otherwise noted						
Parameter	Symbol	Test Conditions	Value			Unit
			Min.	Typ.	Max.	
<b>Static</b>						
Drain-Source Breakdown Voltage	$V_{(BR)DSS}$	$V_{GS} = 0V, I_D = 250\mu\text{A}$	-60	--	--	V
Zero Gate Voltage Drain Current	$I_{DSS}$	$V_{DS} = 60V, V_{GS} = 0V, T_J = 25^\circ\text{C}$	--	--	1	$\mu\text{A}$
		$V_{DS} = 48V, V_{GS} = 0V, T_J = 125^\circ\text{C}$	--	--	100	
Gate-Source Leakage	$I_{GSS}$	$V_{GS} = \pm 20V$	--	--	$\pm 100$	nA
Gate-Source Threshold Voltage	$V_{GS(th)}$	$V_{DS} = V_{GS}, I_D = 250\mu\text{A}$	-2.0	--	-4.0	V
Drain-Source On-Resistance (Note3)	$R_{DS(on)}$	$V_{GS} = 10V, I_D = 17.5A$	--	40	55	m $\Omega$
<b>Dynamic</b>						
Input Capacitance	$C_{iss}$	$V_{GS} = 0V,$ $V_{DS} = 30V,$ $f = 1.0\text{MHz}$	--	1489	--	$\mu\text{F}$
Output Capacitance	$C_{oss}$		--	280	--	
Reverse Transfer Capacitance	$C_{rss}$		--	80	--	
Total Gate Charge	$Q_g$	$V_{DD} = 30V, I_D = 35A,$ $V_{GS} = 10V$	--	40	--	nC
Gate-Source Charge	$Q_{gs}$		--	6	--	
Gate-Drain Charge	$Q_{gd}$		--	20	--	
Turn-on Delay Time	$t_{d(on)}$	$V_{DD} = 30V, I_D = 15A,$ $R_G = 6\Omega$	--	15	--	ns
Turn-on Rise Time	$t_r$		--	30	--	
Turn-off Delay Time	$t_{d(off)}$		--	40	--	
Turn-off Fall Time	$t_f$		--	20	--	
<b>Drain-Source Body Diode Characteristics</b>						
Continuous Body Diode Current	$I_S$	$T_C = 25^\circ\text{C}$	--	--	-35	A
Pulsed Diode Forward Current	$I_{SM}$		--	--	-140	
Body Diode Voltage	$V_{SD}$	$T_J = 25^\circ\text{C}, I_{SD} = 25A, V_{GS} = 0V$	--	--	-2	V
Reverse Recovery Time	$t_{rr}$	$V_{GS} = 0V, I_S = 50A,$ $di_F/dt = 100A/\mu\text{s}$	--	68	--	ns
Reverse Recovery Charge	$Q_{rr}$		--	4.2	--	$\mu\text{C}$

**Notes**

1. Repetitive Rating: Pulse width limited by maximum junction temperature
2.  $L=1\text{mH}, V_{DD} = 50V, R_G = 25\Omega$ , Starting  $T_J = 25^\circ\text{C}$
3. Pulse Test: Pulse width  $\leq 300\mu\text{s}$ , Duty Cycle  $\leq 1\%$

Typical Characteristics  $T_J = 25^\circ\text{C}$ , unless otherwise noted

Figure 1. Output Characteristics ( $T_J = 25^\circ\text{C}$ )

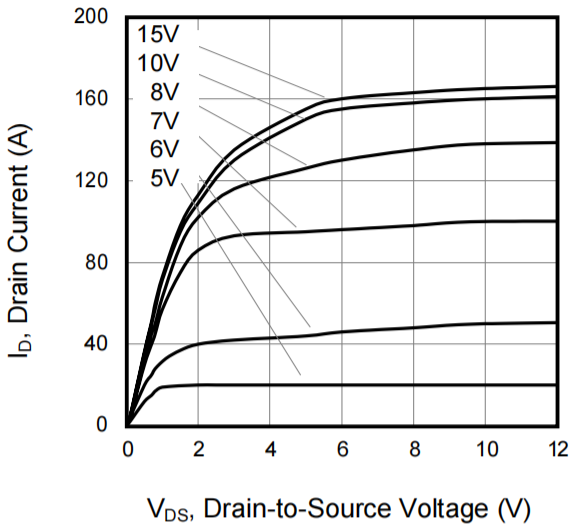

Figure 2. Body Diode Forward Voltage

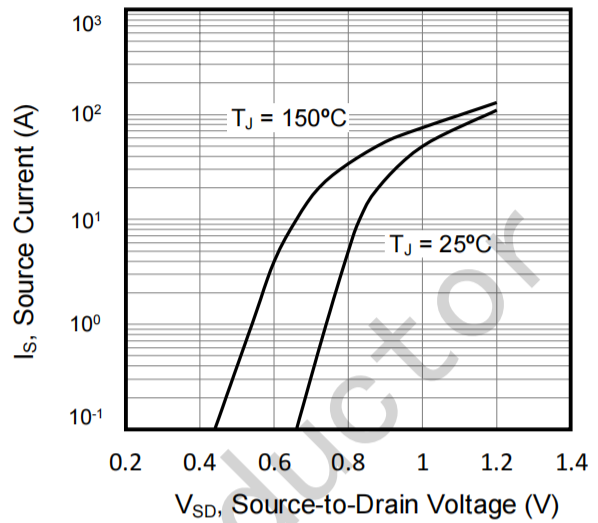

Figure 3. Drain Current vs. Temperature

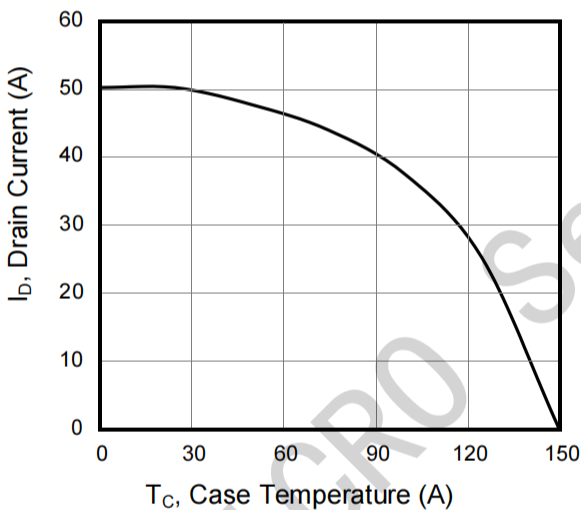

Figure 4.  $BV_{DSS}$  Variation vs. Temperature

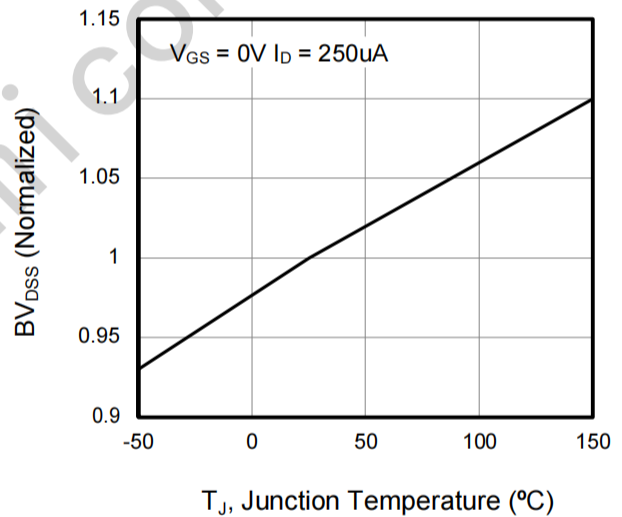

Figure 5. Transfer Characteristics

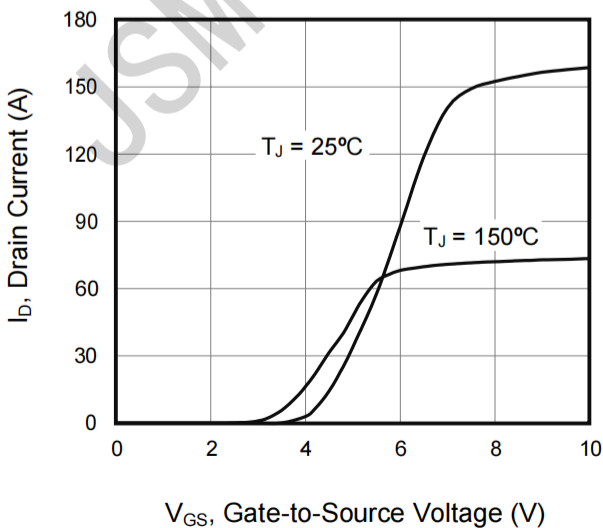
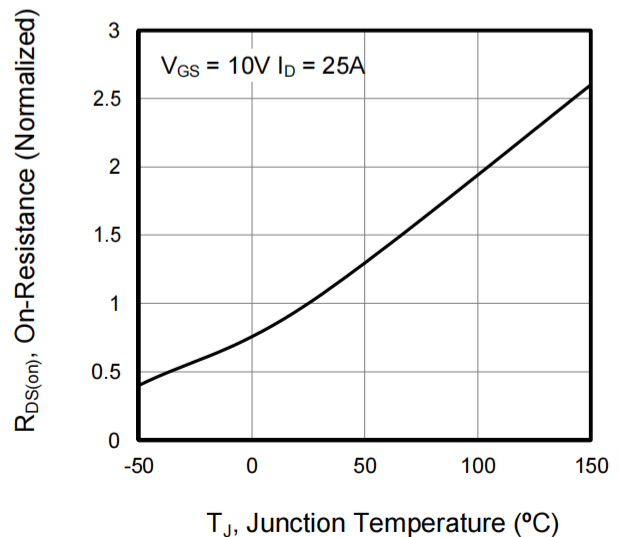

Figure 6. On-Resistance vs. Temperature



Typical Characteristics  $T_J = 25\text{ C}$ , unless otherwise noted

Figure 7. Capacitance

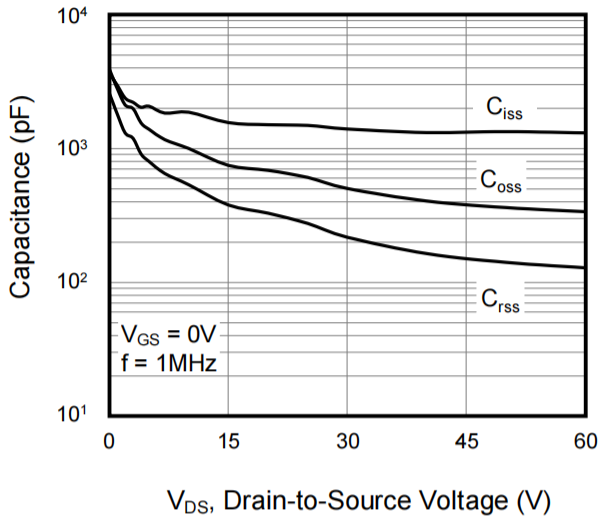

Figure 8. Gate Charge

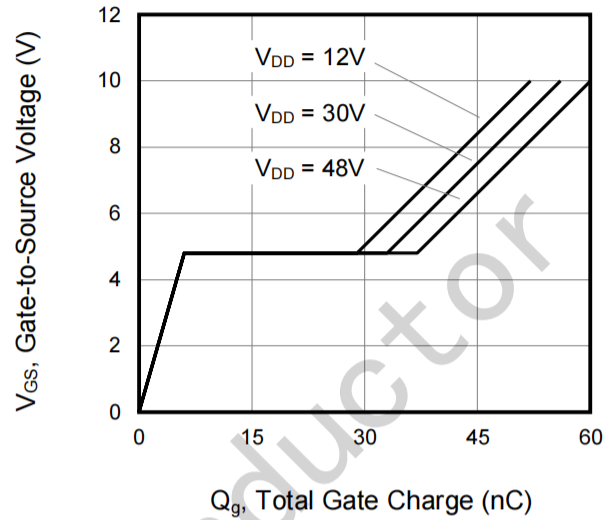
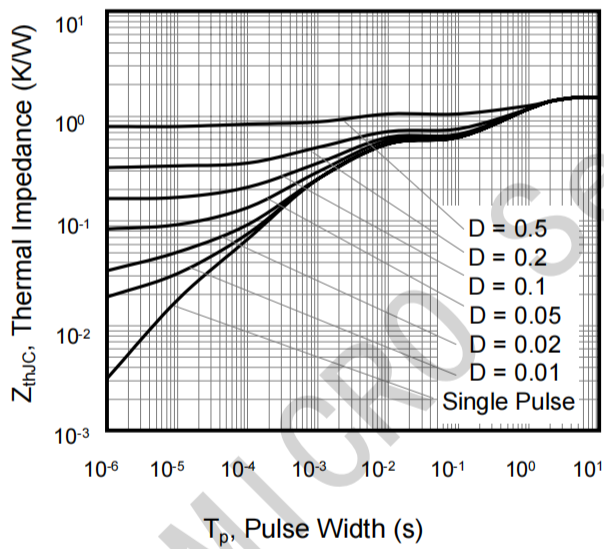
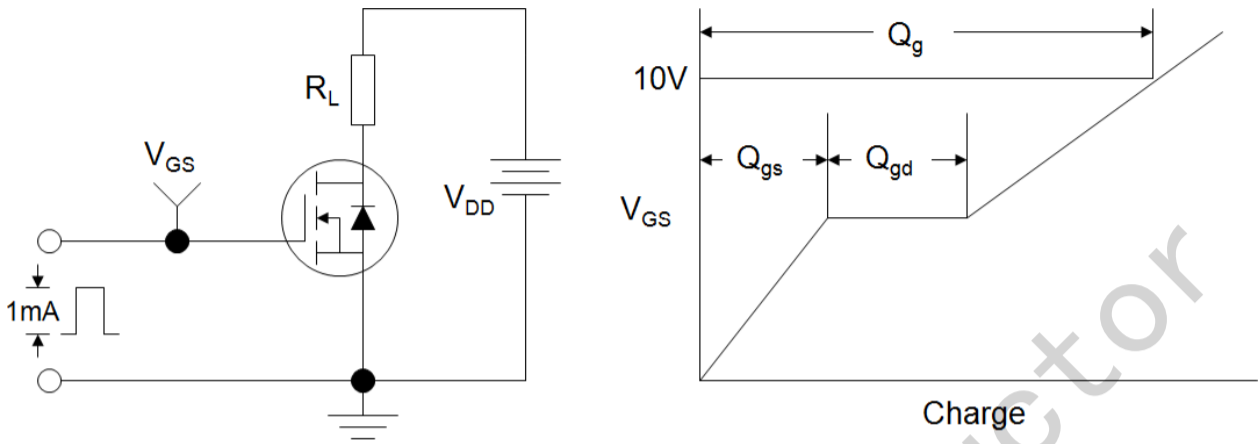

Figure 9. Transient Thermal Impedance  
TO-263



**Figure A: Gate Charge Test Circuit and Waveform**



**Figure B: Resistive Switching Test Circuit and Waveform**

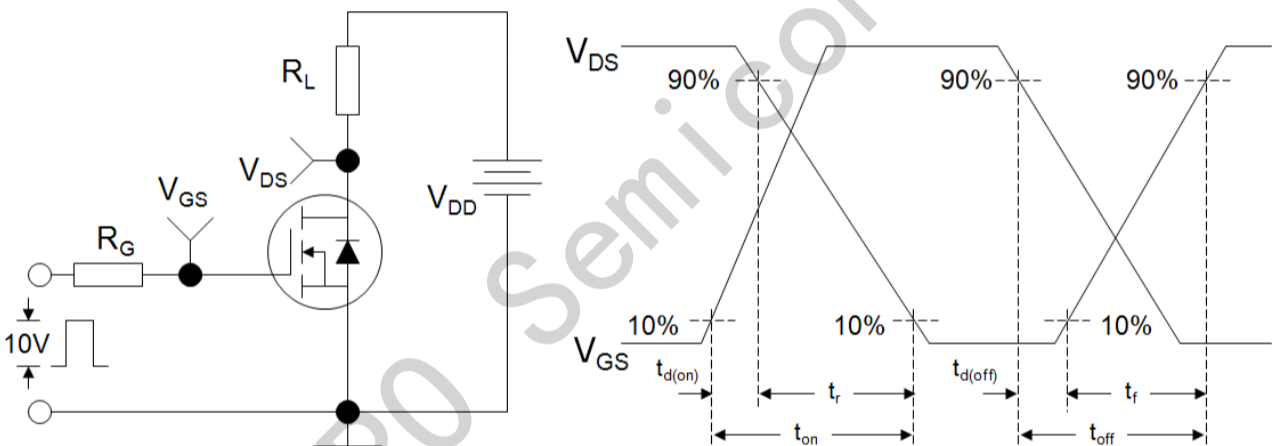

**Figure C: Unclamped Inductive Switching Test Circuit and Waveform**

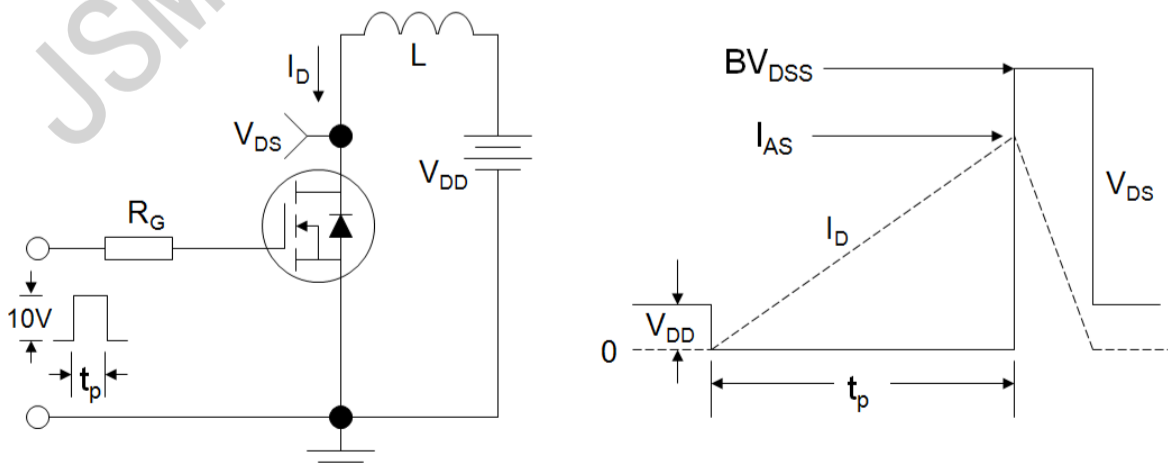

Package Outline: TO-263

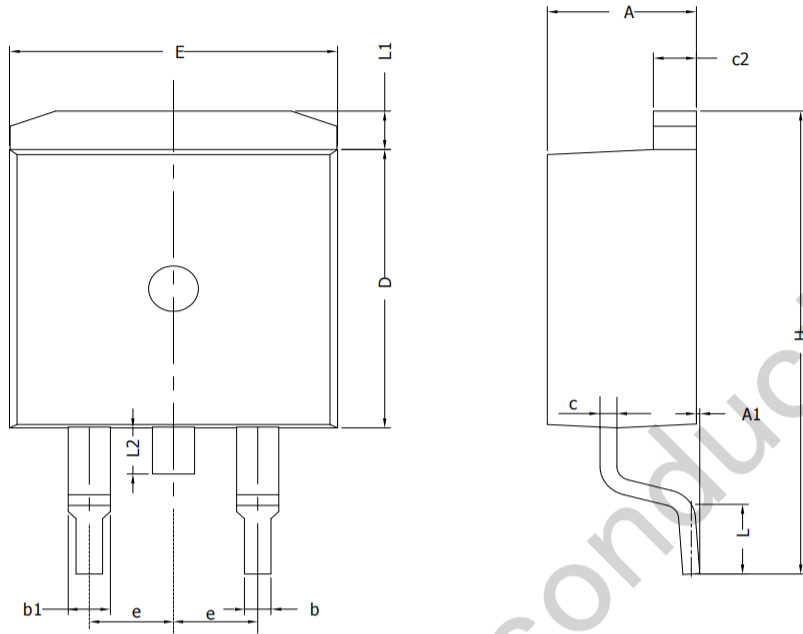

SYMBOL	MIN	NOM	MAX
A	4.30	4.57	4.72
A1	0	0.10	0.25
b	0.71	0.81	0.91
c	0.30	---	0.60
c2	1.17	1.27	1.37
D	8.50	---	9.35
E	9.80	---	10.45
e	2.54BSC		
H	14.70	---	15.75
L	2.00	2.30	2.74
L1	1.12	1.27	1.42
L2	---	---	1.75