

FEATURES

- Fast switching
- 100% avalanche tested
- Improved dv/dt capability

APPLICATIONS

- Switch Mode Power Supply (SMPS)
- Uninterruptible Power Supply (UPS)
- Power Factor Correction (PFC)

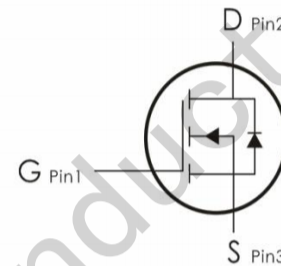
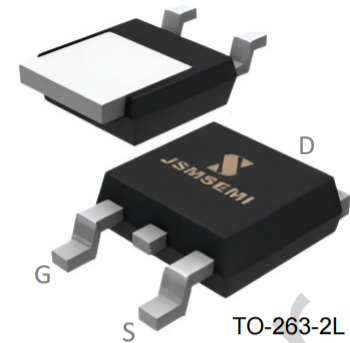

Device Marking and Package Information		
Device	Package	Marking
SPB18P06PGATMA1	TO-263	SPB18P06P

Absolute Maximum Ratings $T_C = 25^\circ\text{C}$, unless otherwise noted			
Parameter	Symbol	Value	Unit
		TO-263	
Drain-Source Voltage ($V_{GS} = 0\text{V}$)	V_{DSS}	-60	V
Continuous Drain Current	I_D	-35	A
Pulsed Drain Current (note1)	I_{DM}	-140	A
Gate-Source Voltage	V_{GSS}	± 20	V
Single Pulse Avalanche Energy (note2)	E_{AS}	250	mJ
Avalanche Current (note1)	I_{AR}	-50	A
Repetitive Avalanche Energy (note1)	E_{AR}	36	mJ
Power Dissipation ($T_C = 25^\circ\text{C}$)	P_D	110	W
Operating Junction and Storage Temperature Range	T_J, T_{stg}	-55~+150	$^\circ\text{C}$

Thermal Resistance			
Parameter	Symbol	Value	Unit
		TO-263	
Thermal Resistance, Junction-to-Case	R_{thJC}	1.14	KW
Thermal Resistance, Junction-to-Ambient	R_{thJA}	60	

Specifications $T_J = 25^\circ\text{C}$, unless otherwise noted						
Parameter	Symbol	Test Conditions	Value			Unit
			Min.	Typ.	Max.	
Static						
Drain-Source Breakdown Voltage	$V_{(BR)DSS}$	$V_{GS} = 0V, I_D = 250\mu A$	-60	--	--	V
Zero Gate Voltage Drain Current	I_{DSS}	$V_{DS} = 60V, V_{GS} = 0V, T_J = 25^\circ\text{C}$	--	--	1	μA
		$V_{DS} = 48V, V_{GS} = 0V, T_J = 125^\circ\text{C}$	--	--	100	
Gate-Source Leakage	I_{GSS}	$V_{GS} = \pm 20V$	--	--	± 100	nA
Gate-Source Threshold Voltage	$V_{GS(th)}$	$V_{DS} = V_{GS}, I_D = 250\mu A$	-2.0	--	-4.0	V
Drain-Source On-Resistance (Note3)	$R_{DS(on)}$	$V_{GS} = 10V, I_D = 17.5A$	--	40	55	m Ω
Dynamic						
Input Capacitance	C_{iss}	$V_{GS} = 0V,$ $V_{DS} = 30V,$ $f = 1.0\text{MHz}$	--	1489	--	μF
Output Capacitance	C_{oss}		--	280	--	
Reverse Transfer Capacitance	C_{rss}		--	80	--	
Total Gate Charge	Q_g	$V_{DD} = 30V, I_D = 35A,$ $V_{GS} = 10V$	--	40	--	nC
Gate-Source Charge	Q_{gs}		--	6	--	
Gate-Drain Charge	Q_{gd}		--	20	--	
Turn-on Delay Time	$t_{d(on)}$	$V_{DD} = 30V, I_D = 15A,$ $R_G = 6\ \Omega$	--	15	--	ns
Turn-on Rise Time	t_r		--	30	--	
Turn-off Delay Time	$t_{d(off)}$		--	40	--	
Turn-off Fall Time	t_f		--	20	--	
Drain-Source Body Diode Characteristics						
Continuous Body Diode Current	I_S	$T_C = 25^\circ\text{C}$	--	--	-35	A
Pulsed Diode Forward Current	I_{SM}		--	--	-140	
Body Diode Voltage	V_{SD}	$T_J = 25^\circ\text{C}, I_{SD} = 25A, V_{GS} = 0V$	--	--	-2	V
Reverse Recovery Time	t_{rr}	$V_{GS} = 0V, I_S = 50A,$ $di_F/dt = 100A/\mu s$	--	68	--	ns
Reverse Recovery Charge	Q_{rr}		--	4.2	--	μC

Notes

1. Repetitive Rating: Pulse width limited by maximum junction temperature
2. $L=1\text{mH}, V_{DD} = 50V, R_G = 25\ \Omega$, Starting $T_J = 25^\circ\text{C}$
3. Pulse Test: Pulse width $\leq 300\mu s$, Duty Cycle $\leq 1\%$

Typical Characteristics $T_J = 25^\circ\text{C}$, unless otherwise noted

Figure 1. Output Characteristics ($T_J = 25^\circ\text{C}$)

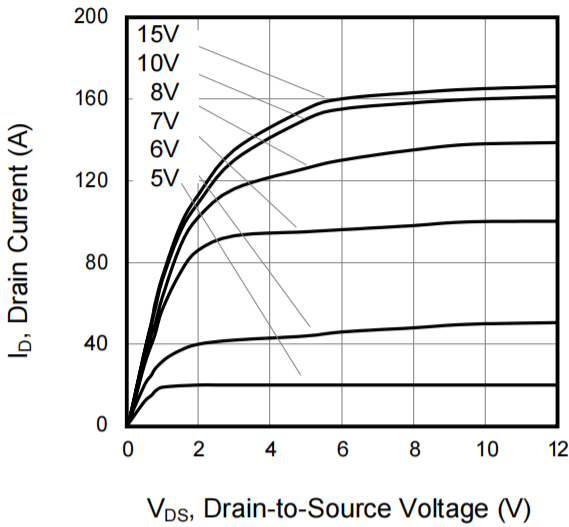

Figure 2. Body Diode Forward Voltage

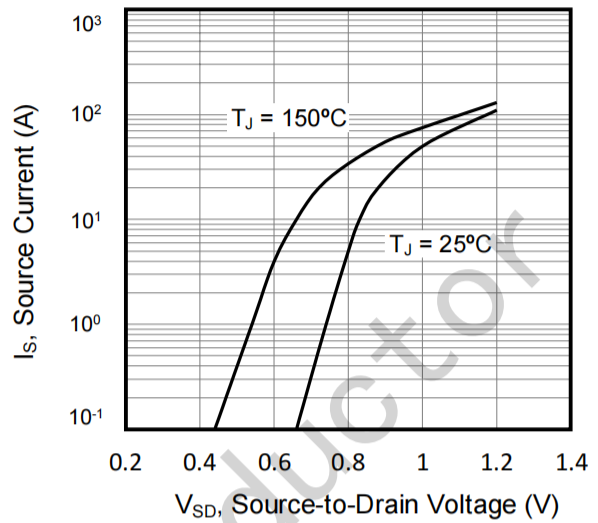

Figure 3. Drain Current vs. Temperature

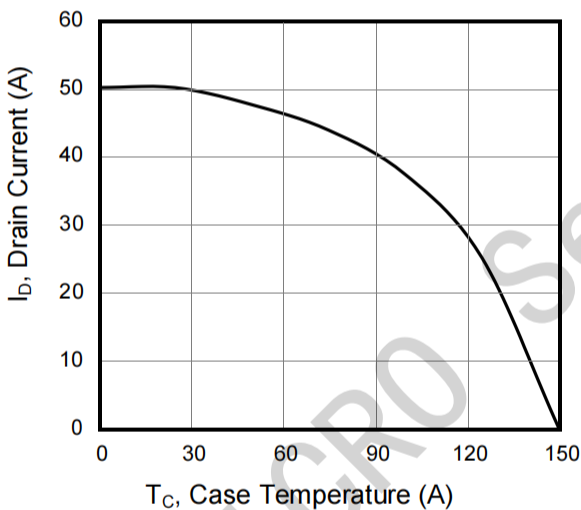

Figure 4. BV_{DSS} Variation vs. Temperature

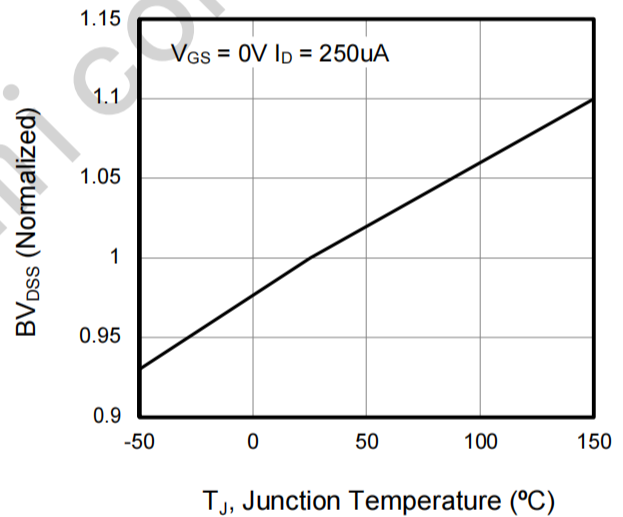

Figure 5. Transfer Characteristics

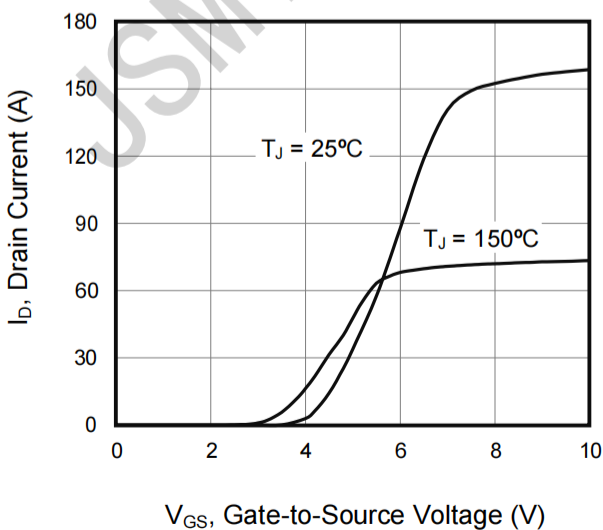
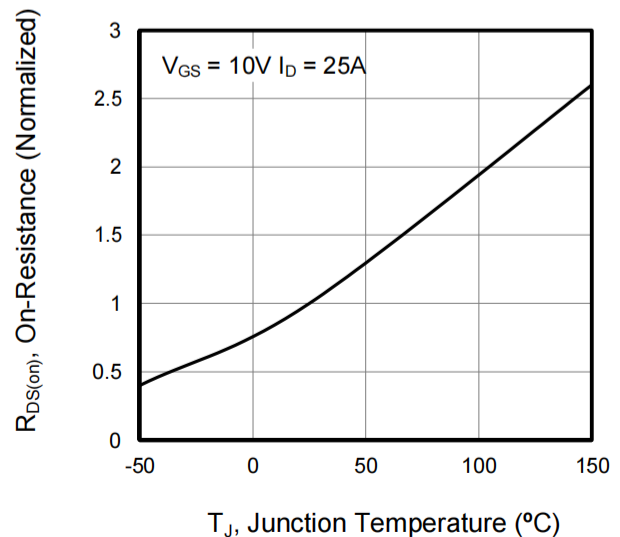

Figure 6. On-Resistance vs. Temperature



Typical Characteristics $T_J = 25\text{ C}$, unless otherwise noted

Figure 7. Capacitance

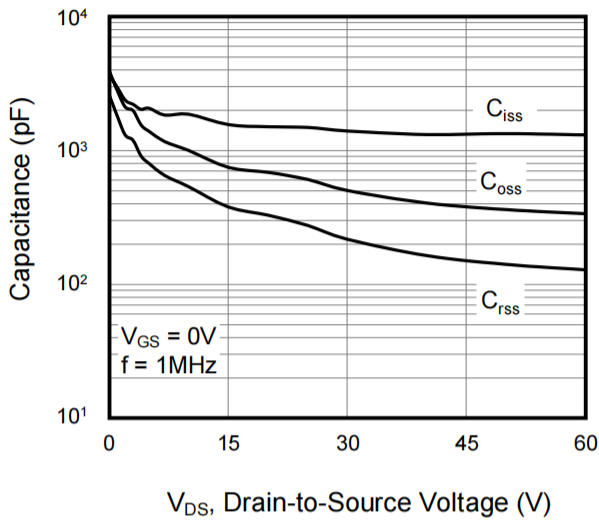

Figure 8. Gate Charge

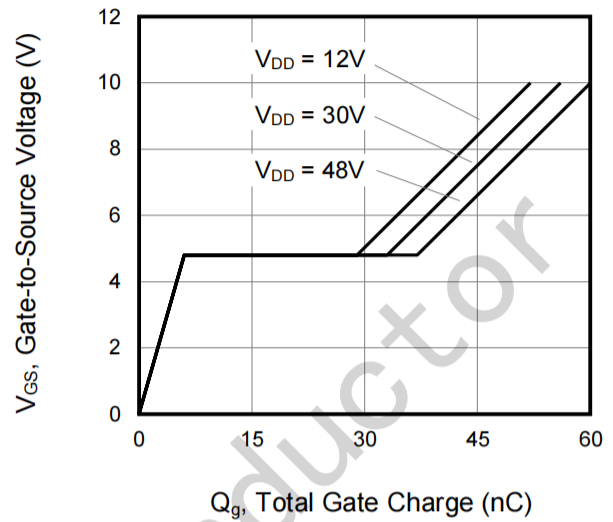

Figure 9. Transient Thermal Impedance
TO-263

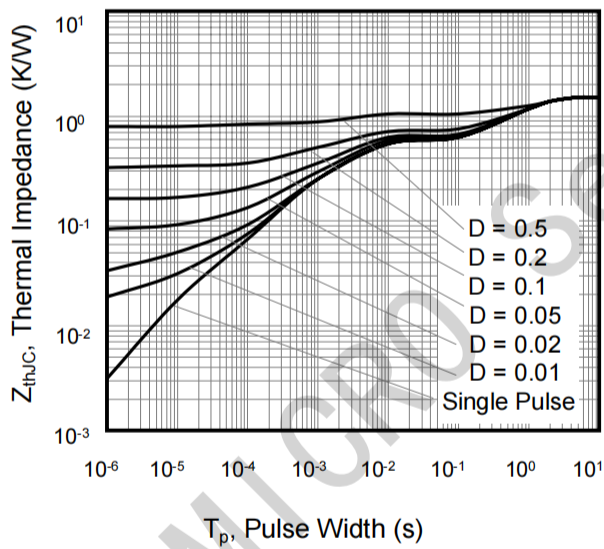

Figure A: Gate Charge Test Circuit and Waveform

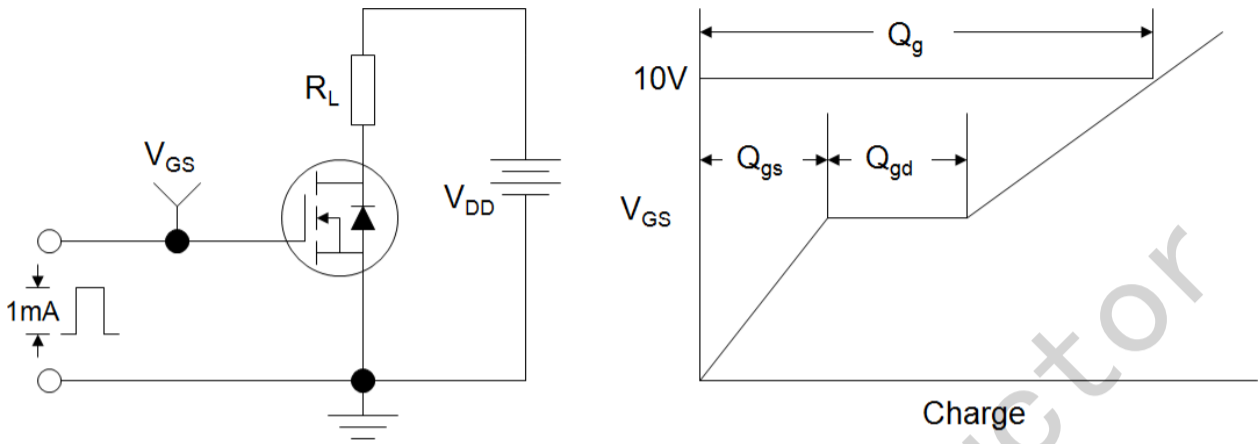

Figure B: Resistive Switching Test Circuit and Waveform

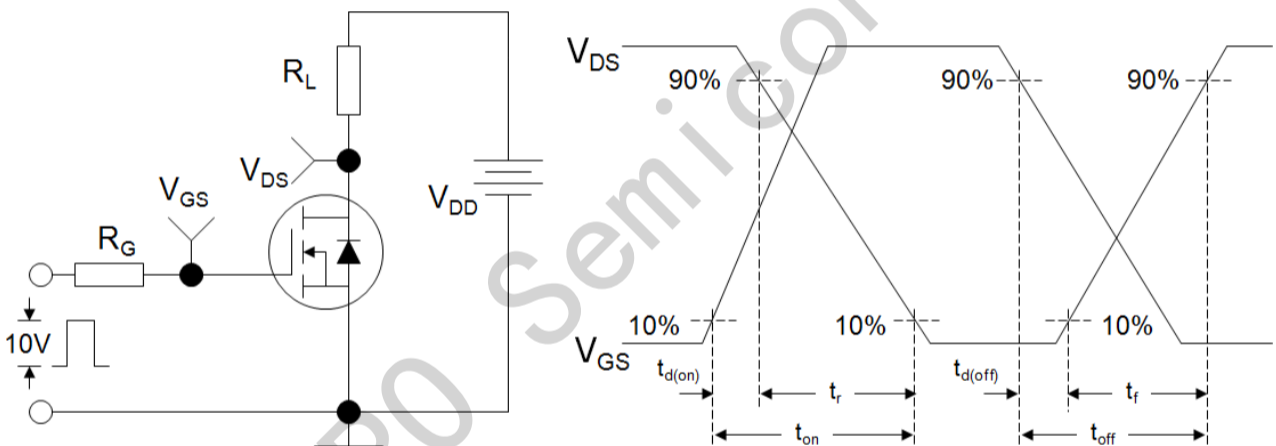
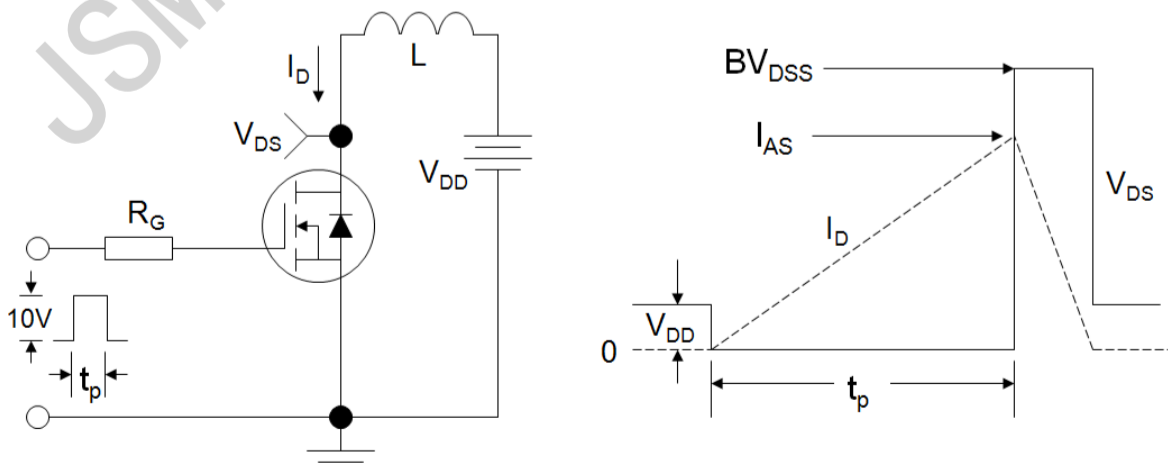
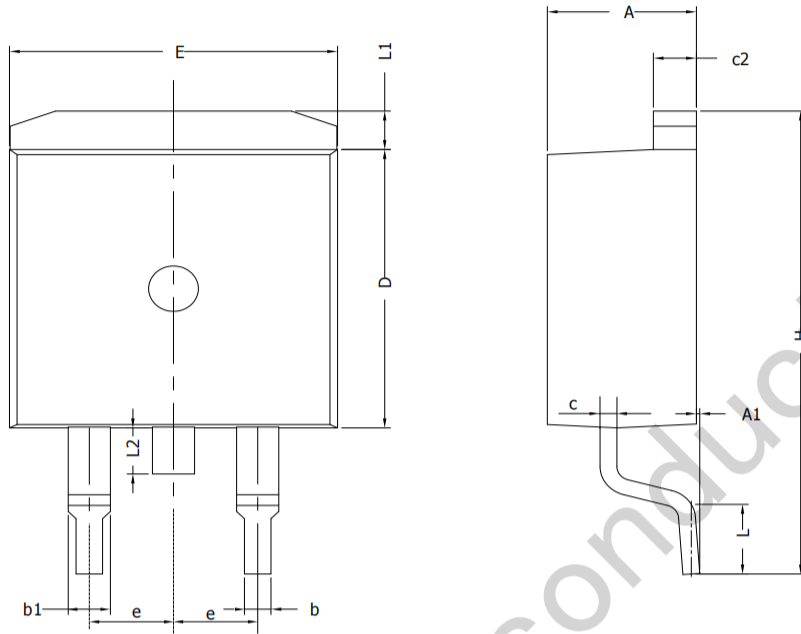

Figure C: Unclamped Inductive Switching Test Circuit and Waveform



Package Outline: TO-263



SYMBOL	MIN	NOM	MAX
A	4.30	4.57	4.72
A1	0	0.10	0.25
b	0.71	0.81	0.91
c	0.30	---	0.60
c2	1.17	1.27	1.37
D	8.50	---	9.35
E	9.80	---	10.45
e	2.54BSC		
H	14.70	---	15.75
L	2.00	2.30	2.74
L1	1.12	1.27	1.42
L2	---	---	1.75