

Dual Bias Resistor Transistors

NPN and PNP Silicon Surface Mount

Transistors with Monolithic Bias

Resistor Network

The BRT (Bias Resistor Transistor) contains a single transistor with a monolithic bias network consisting of two resistors; a series base resistor and a base-emitter resistor. These digital transistors are designed to replace a single device and its external resistor bias network. The BRT eliminates these individual components by integrating them into a single device. In the MMUN5311DWseries, two complementary BRT devices are housed in the SOT-363 package which is ideal for low power surface mount applications where board space is at a premium.

- Simplifies Circuit Design
- Reduces Board Space
- Reduces Component Count
- We declare that the material of product compliance with RoHS requirements.

MAXIMUM RATINGS ($T_A = 25^\circ\text{C}$ unless otherwise noted, common for Q 1 and Q 2, – minus sign for Q 1 (PNP) omitted)

Rating	Symbol	Value	Unit
Collector-Base Voltage	V_{CBO}	50	Vdc
Collector-Emitter Voltage	V_{CEO}	50	Vdc
Collector Current	I_C	100	mAdc

THERMAL CHARACTERISTICS

Characteristic (One Junction Heated)	Symbol	Max	Unit
Total Device Dissipation $T_A = 25^\circ\text{C}$	P_D	187 (Note 1.) 256 (Note 2.)	mW
Derate above 25°C		1.5 (Note 1.) 2.0 (Note 2.)	mW/ $^\circ\text{C}$
Thermal Resistance – Junction-to-Ambient	$R_{\theta JA}$	670 (Note 1.) 490 (Note 2.)	$^\circ\text{C}/\text{W}$
Characteristic (Both Junctions Heated)	Symbol	Max	Unit
Total Device Dissipation $T_A = 25^\circ\text{C}$	P_D	250 (Note 1.) 385 (Note 2.)	mW
Derate above 25°C		2.0 (Note 1.) 3.0 (Note 2.)	mW/ $^\circ\text{C}$
Thermal Resistance – Junction-to-Ambient	$R_{\theta JA}$	493 (Note 1.) 325 (Note 2.)	$^\circ\text{C}/\text{W}$
Thermal Resistance – Junction-to-Lead	$R_{\theta JL}$	188 (Note 1.) 208 (Note 2.)	$^\circ\text{C}/\text{W}$
Junction and Storage Temperature	T_J, T_{stg}	-55 to +150	$^\circ\text{C}$

1. FR-4 @ Minimum Pad 2. FR-4 @ 1.0 x 1.0 inch Pad

MMUN5311DW Series

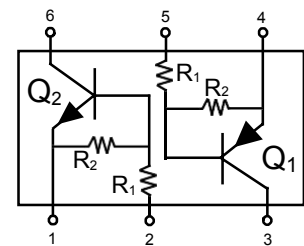
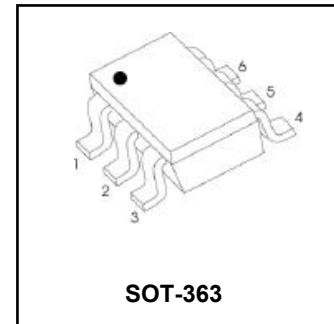

MARKING DIAGRAM

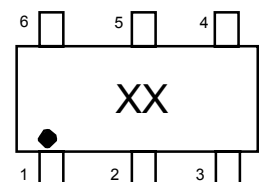

xx = Device Marking
(See Page 2)

DEVICE MARKING INFORMATION

See specific marking information in the device marking table on page 2 of this data sheet.

ORDERING, SHIPPING, DEVICE MARKING AND RESISTOR VALUES

Device	Package	Marking	R1(K)	R2(K)	Shipping
MMUN5311DW	SOT-363	11	10	10	3000/Tape&Reel
MMUN5312DW	SOT-363	12	22	22	3000/Tape&Reel
MMUN5313DW	SOT-363	13	47	47	3000/Tape&Reel
MMUN5314DW	SOT-363	14	10	47	3000/Tape&Reel
MMUN5315DW	SOT-363	15	10	Ġ	3000/Tape&Reel
MMUN5316DW	SOT-363	16	4.7	Ġ	3000/Tape&Reel
MMUN5330DW	SOT-363	30	1	1	3000/Tape&Reel
MMUN5331DW	SOT-363	31	2.2	2.2	3000/Tape&Reel
MMUN5332DW	SOT-363	32	4.7	4.7	3000/Tape&Reel
MMUN5333DW	SOT-363	33	4.7	47	3000/Tape&Reel
MMUN5334DW	SOT-363	34	22	47	3000/Tape&Reel
MMUN5335DW	SOT-363	35	2.2	47	3000/Tape&Reel

ELECTRICAL CHARACTERISTICS

(T_A = 25°C unless otherwise noted, common for Q₁ and Q₂, - minus sign for Q₁ (PNP) omitted) (Continued)

Characteristic	Symbol	Min	Typ	Max	Unit	
ON CHARACTERISTICS (Note 4)						
DC Current Gain (V _{CE} = 10 V, I _C = 5.0 mA)	MMUN5311DW MMUN5312DW MMUN5313DW MMUN5314DW MMUN5315DW MMUN5316DW MMUN5330DW MMUN5331DW MMUN5332DW MMUN5333DW MMUN5334DW MMUN5335DW	h _{FE}	35 60 80 80 160 160 3.0 8.0 15 80 80 80	60 100 140 140 350 350 5.0 15 30 200 150 140	- - - - - - - - - - - -	
Collector-Emitter Saturation Voltage (I _C = 10 mA, I _B = 0.3 mA) (I _C = 10 mA, I _B = 5 mA) MMUN5330DW /MMUN5331DW (I _C = 10 mA, I _B = 1 mA) MMUN5315DW/MMUN5316DW MMUN5332DW /MMUN5333DW /MMUN5334DW		V _{CE(sat)}	-	-	0.25	Vdc
Output Voltage (on) (V _{CC} = 5.0 V, V _B = 2.5 V, R _L = 1.0 kfi)	MMUN5311DW MMUN5312DW MMUN5314DW MMUN5315DW MMUN5316DW MMUN5330DW MMUN5331DW MMUN5332DW MMUN5333DW MMUN5334DW MMUN5335DW MMUN5313DW	V _{OL}	- - - - - - - - - - - -	- - - - - - - - - - - -	0.2 0.2 0.2 0.2 0.2 0.2 0.2 0.2 0.2 0.2 0.2 0.2	Vdc
Output Voltage (off) (V _{CC} = 5.0 V, V _B = 0.5 V, R _L = 1.0 kfi) (V _{CC} = 5.0 V, V _B = 0.050 V, R _L = 1.0 kfi) (V _{CC} = 5.0 V, V _B = 0.25 V, R _L = 1.0 kfi)	MMUN5330DW MMUN5315DW MMUN5316DW MMUN5333DW	V _{OH}	4.9	-	-	Vdc
Input Resistor	MMUN5311DW MMUN5312DW MMUN5313DW MMUN5314DW MMUN5315DW MMUN5316DW MMUN5330DW MMUN5331DW MMUN5332DW MMUN5333DW MMUN5334DW MMUN5335DW	R1	7.0 15.4 32.9 7.0 7.0 3.3 0.7 1.5 3.3 3.3 15.4 1.54	10 22 47 10 10 4.7 1.0 2.2 4.7 4.7 22 2.2	13 28.6 61.1 13 13 6.1 1.3 2.9 6.1 6.1 28.6 2.86	k fi
Resistor Ratio	MMUN5311DW /MMUN5312DW MMUN5313DW MMUN5314DW /MMUN5316DW MMUN5330DW /MMUN5331DW MMUN5332DW MMUN5333DW MMUN5334DW MMUN5335DW	R1/R2	0.8 0.17 - 0.8 0.055 0.38 0.038	1.0 0.21 - 1.0 0.1 0.47 0.047	1.2 0.25 - 1.2 0.185 0.56 0.056	

ELECTRICAL CHARACTERISTICS

(T_A = 25°C unless otherwise noted, common for Q₁ and Q₂, - minus sign for Q₁ (PNP) omitted)

Characteristic	Symbol	Min	Typ	Max	Unit
OFF CHARACTERISTICS					
Collector-Base Cutoff Current (V _{CB} = 50 V, I _E = 0)	I _{CBO}	-	-	100	nAdc
Collector-Emitter Cutoff Current (V _{CE} = 50 V, I _B = 0)	I _{CEO}	-	-	500	nAdc
Emitter-Base Cutoff Current (V _{EB} = 6.0 V, I _C = 0)	MMUN5311DW	-	-	0.5	mAdc
	MMUN5312DW	-	-	0.2	
	MMUN5313DW	-	-	0.1	
	MMUN5314DW	-	-	0.2	
	MMUN5315DW	-	-	0.9	
	MMUN5316DW	-	-	1.9	
	MMUN5330DW	-	-	4.3	
	MMUN5331DW	-	-	2.3	
	MMUN5332DW	-	-	1.5	
	MMUN5333DW	-	-	0.18	
	MMUN5334DW	-	-	0.13	
MMUN5335DW	-	-	0.2		
Collector-Base Breakdown Voltage (I _C = 10 μA, I _E = 0)	V _{(BR)CBO}	50	-	-	Vdc
Collector-Emitter Breakdown Voltage (Note 3) (I _C = 2.0 mA, I _B = 0)	V _{(BR)CEO}	50	-	-	Vdc

3. Pulse Test: Pulse Width < 300 μs, Duty Cycle < 2.0%

ALL MMUN5311DW1T1G SERIES DEVICES

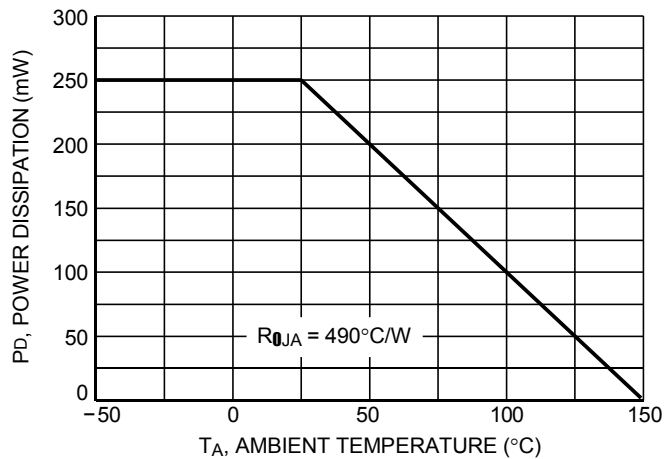

Figure 1. Derating Curve

TYPICAL ELECTRICAL CHARACTERISTICS – MMUN5311DW NPN TRANSISTOR

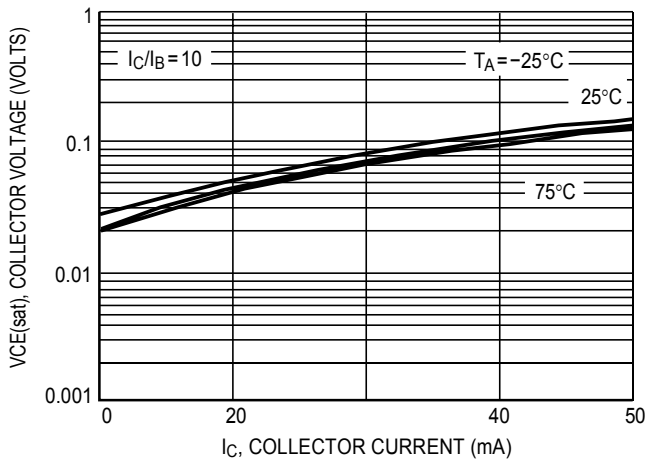

Figure 2. $V_{CE(sat)}$ versus I_C

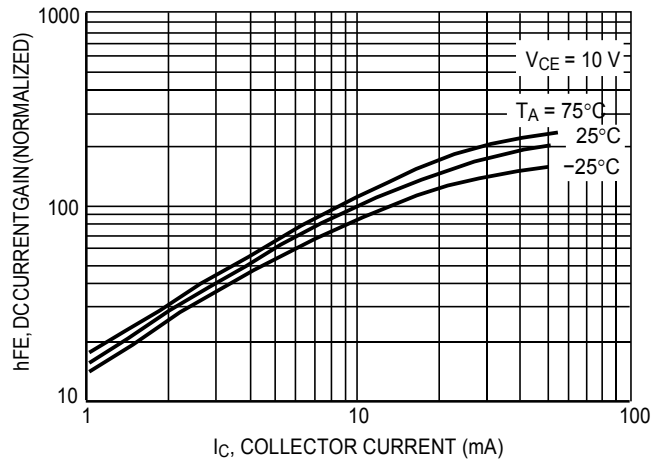

Figure 3. DC Current Gain

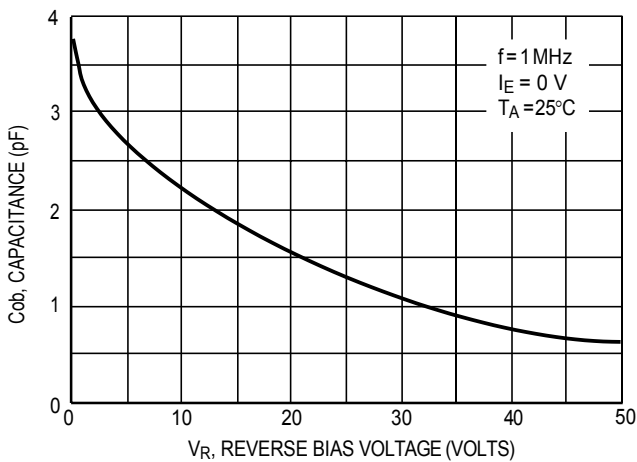

Figure 4. Output Capacitance

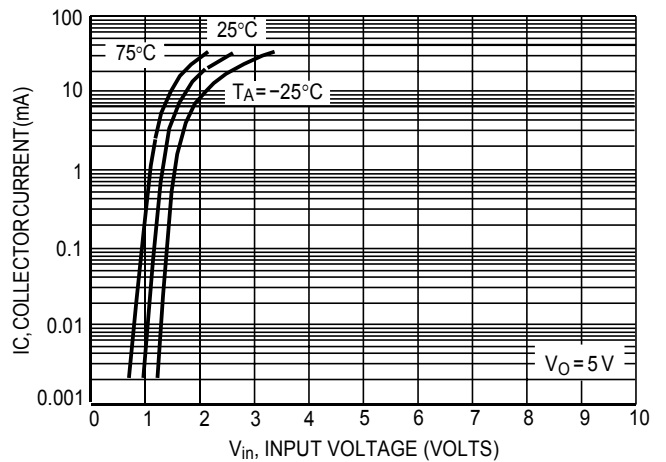

Figure 5. Output Current versus Input Voltage

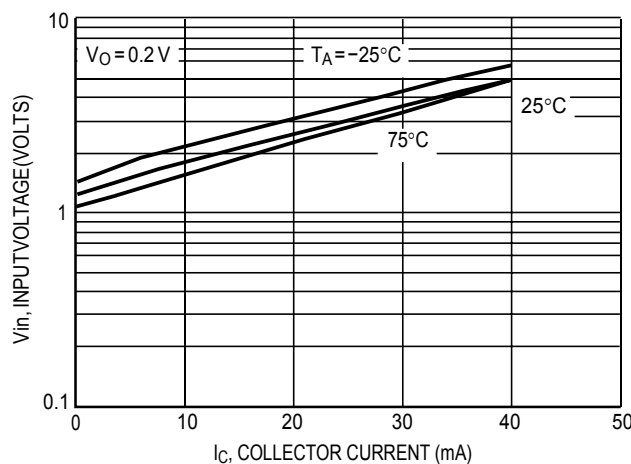

Figure 6. Input Voltage versus Output Current

TYPICAL ELECTRICAL CHARACTERISTICS – MMUN5311DW PNP TRANSISTOR

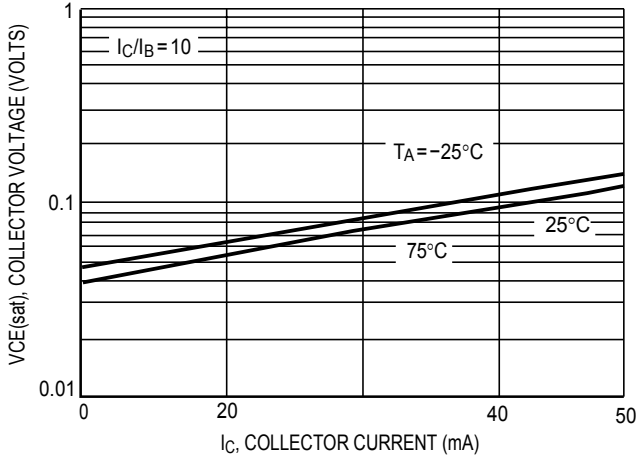

Figure 7. $V_{CE(sat)}$ versus I_C

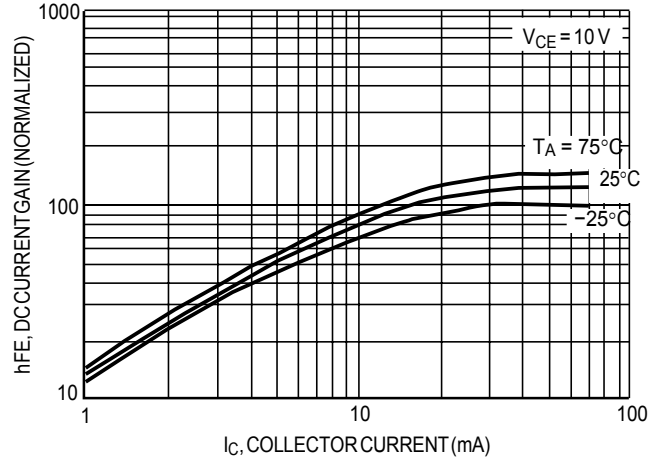

Figure 8. DC Current Gain

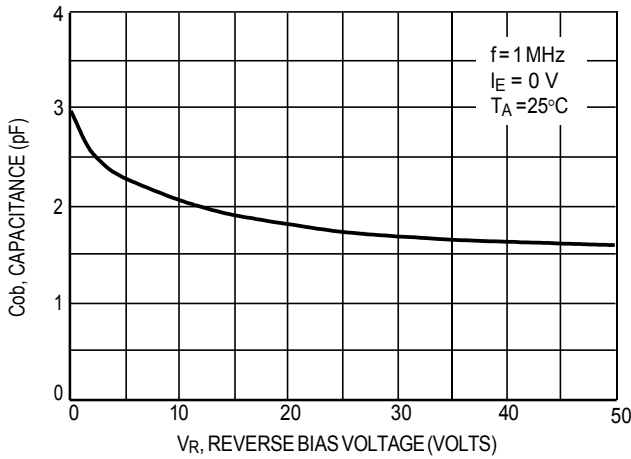

Figure 9. Output Capacitance

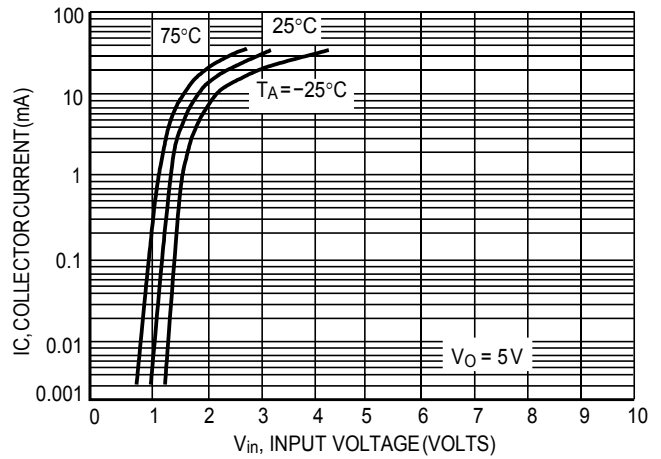

Figure 10. Output Current versus Input Voltage

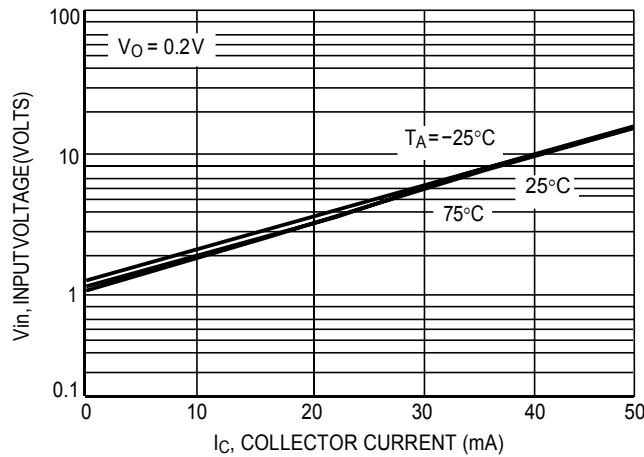

Figure 11. Input Voltage versus Output Current



SOT-363 Package Outline Dimensions

