



Digital Transistors (Built-in Resistors)

DIGITAL TRANSISTOR (NPN)

FEATURES

- Built-in bias resistors enable the configuration of an inverter circuit without connecting external input resistors(see equivalent circuit)
- The bias resistors consist of thin-film resistors with complete isolation to allow negative biasing of the input.They also have the advantage of almost completely eliminating parasitic effects
- Only the on/off conditions need to be set for operation, making device design easy

• Equivalent Circuit

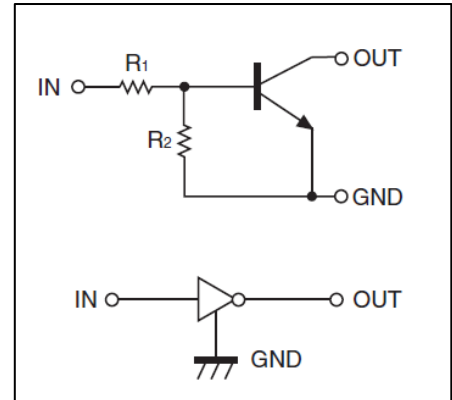

MARKING: 24

PIN CONNENCTIONS and MARKING

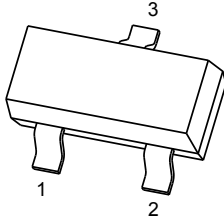
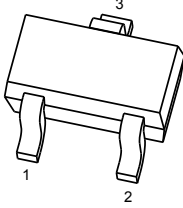
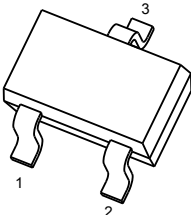
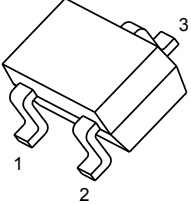
<p>DTC114ECA</p>  <p>SOT-23</p> <p>1. IN 2. GND 3. OUT</p>	<p>DTC114EE</p>  <p>SOT-523</p> <p>1. IN 2. GND 3. OUT</p>
<p>DTC114EUA</p>  <p>SOT-323</p> <p>1. IN 2. GND 3. OUT</p>	<p>DTC114EKA</p>  <p>SOT-23-3L</p> <p>1. IN 2. GND 3. OUT</p>



MAXIMUM RATINGS(Ta=25°C unless otherwise noted)

Symbol	Parameter	Limits(DTC114E□)					Unit
		E	UA	CA	KA		
V _{CC}	Supply Voltage	50					V
V _{IN}	Input Voltage	-10~+40					V
I _O	Output Current	50					mA
I _{CM}	Peak Collector Current	100					mA
P _D	Power Dissipation	150	200	200	200		mW
T _J	Junction Temperature	150					°C
T _{stg}	Storage Temperature	-55~+150					°C

ELECTRICAL CHARACTERISTICS (Ta=25°C unless otherwise specified)

Parameter	Symbol	Conditions	Min	Typ	Max	Unit
Input voltage	V _{I(off)}	V _{CC} =5V, I _O =100μA	0.5			V
	V _{I(on)}	V _O =0.3V, I _O =10mA			3	V
Output voltage	V _{O(on)}	I _O /I _I =10mA/0.5mA			0.3	V
Input current	I _I	V _I =5V			0.88	mA
Output current	I _{O(off)}	V _{CC} =50V, V _I =0			0.5	μA
DC current gain	G _I	V _O =5V, I _O =5mA	30			
Input resistance	R ₁		7	10	13	kΩ
Resistance ratio	R ₂ /R ₁		0.8	1	1.2	
Transition frequency	f _T	V _O =10V, I _O =5mA, f=100MHz		250		MHz

Typical Characteristics

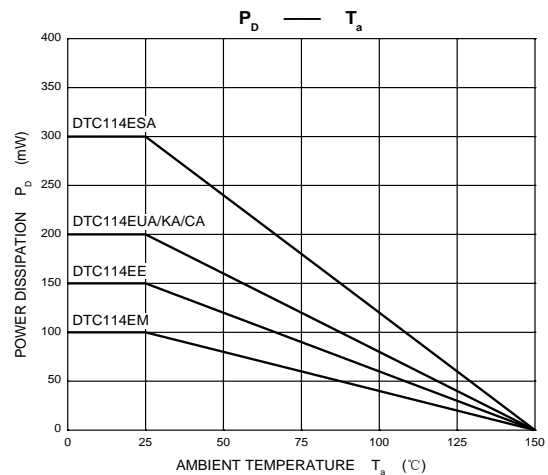
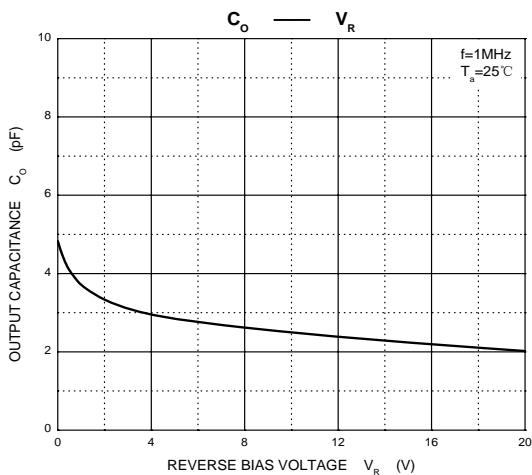
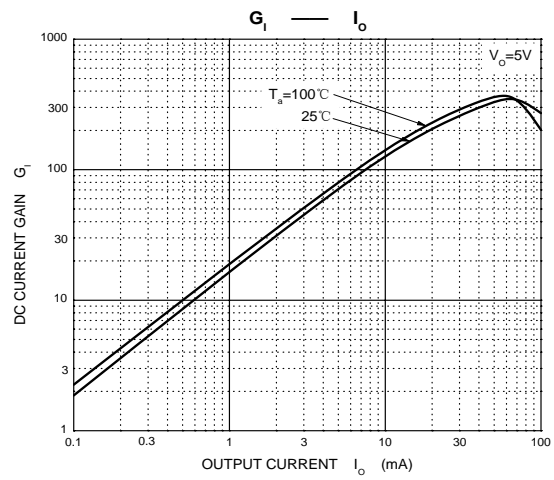
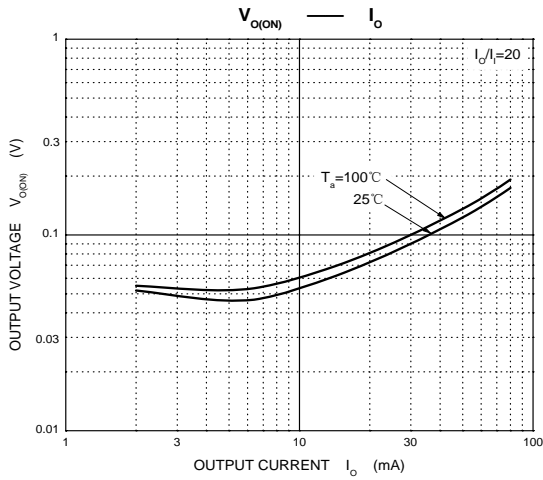
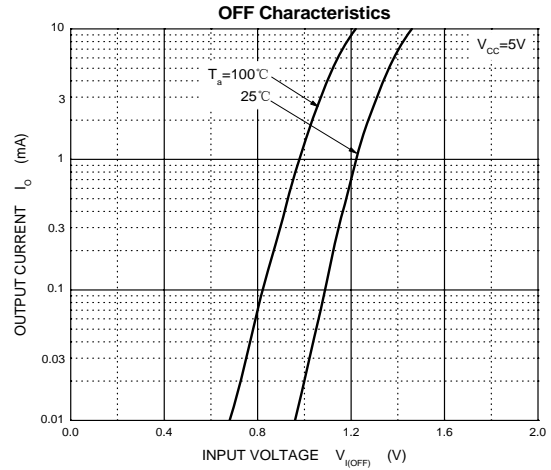
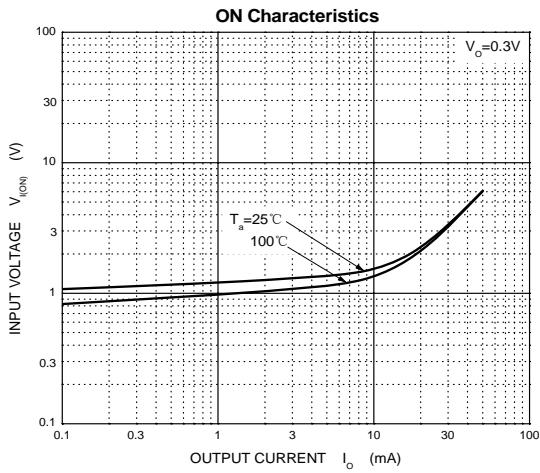



PACKAGE OUTLINE

Plastic surface mounted package; 3 leads

SOT-523

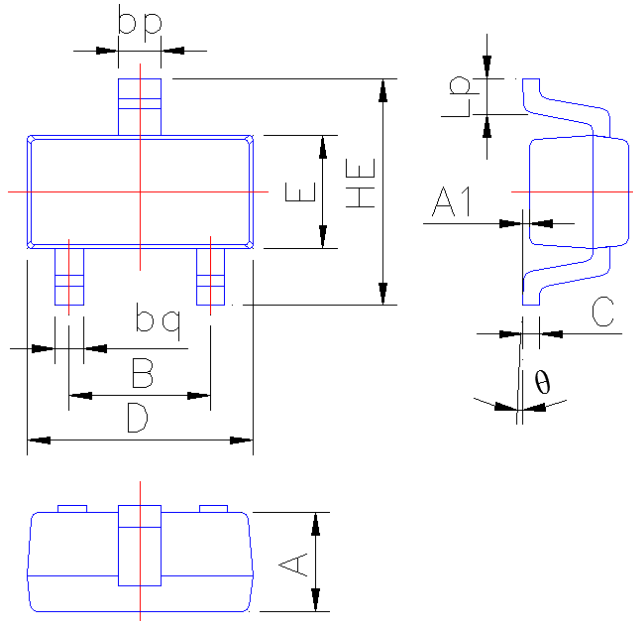

Symbol	Dimension in Millimeters	
	Min	Max
A	0.60	0.80
A1	0.010	0.100
B	0.95	1.05
bp	0.26	0.40
bq	0.16	0.30
C	0.09	0.15
D	1.50	1.70
E	0.70	0.85
HE	1.45	1.75
Lp	0.16	0.36
θ	0°	5°



PACKAGE OUTLINE

Plastic surface mounted package; 3 leads

SOT-323

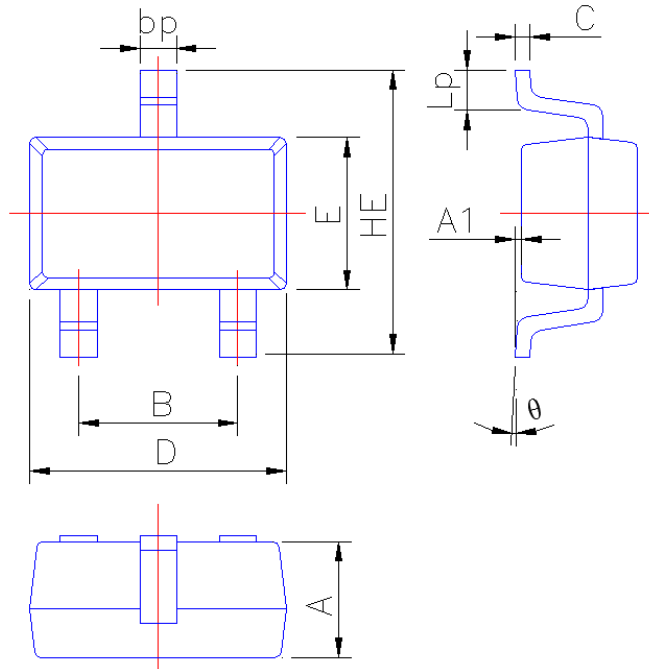

Symbol	Dimension in Millimeters	
	Min	Max
A	0.90	1.00
A1	0.010	0.100
B	1.20	1.40
bp	0.25	0.45
C	0.09	0.15
D	2.00	2.20
E	1.15	1.35
HE	2.15	2.55
Lp	0.25	0.46
θ	0°	6°



Package outline dimensions SOT23-3L

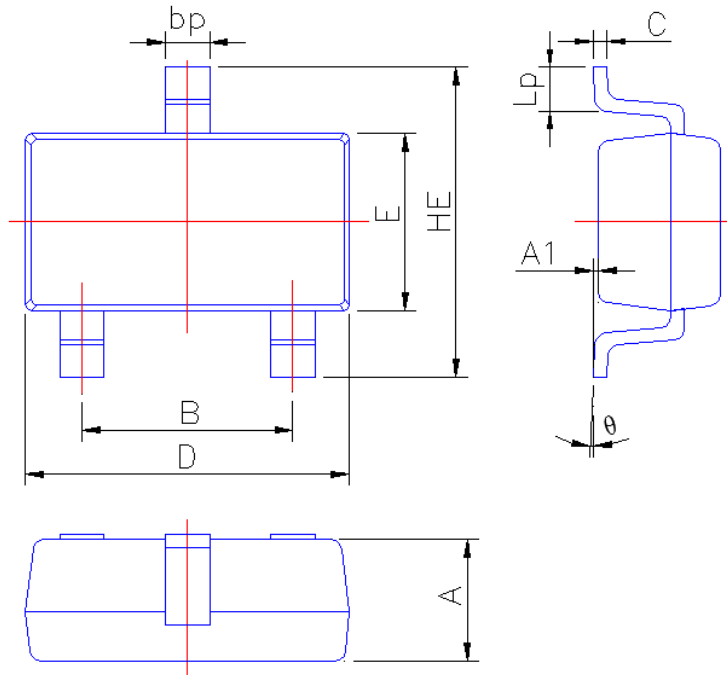

Symbol	Dimension in Millimeters	
	Min	Max
A	1.05	1.20
A1	0.010	0.100
B	1.80	2.00
bp	0.35	0.50
C	0.09	0.15
D	2.80	3.00
E	1.50	1.70
HE	2.60	3.00
Lp	0.25	0.55
θ	2°	6°



PACKAGE OUTLINE

Plastic surface mounted package; 3 leads

SOT-23

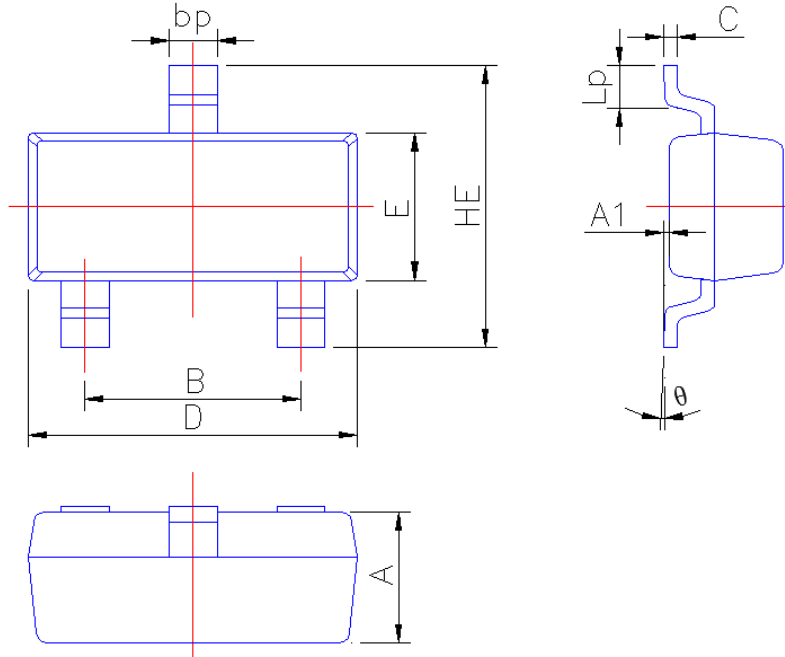

Symbol	Dimension in Millimeters	
	Min	Max
A	0.90	1.10
A1	0.013	0.100
B	1.80	2.00
bp	0.35	0.50
C	0.09	0.150
D	2.80	3.00
E	1.20	1.40
HE	2.20	2.80
Lp	0.20	0.50
θ	0°	5°