

Plastic-Encapsulate MOSFETS

N-CHANNEL ENHANCEMENT MODE MOSFET

Features

- Low On-Resistance
- Low Gate Threshold Voltage
- Low Input Capacitance
- Fast Switching Speed
- Low Input/Output Leakage
- **Lead Free By Design/RoHS Compliant (Note 2)**
- **ESD Protected up to 2kV**

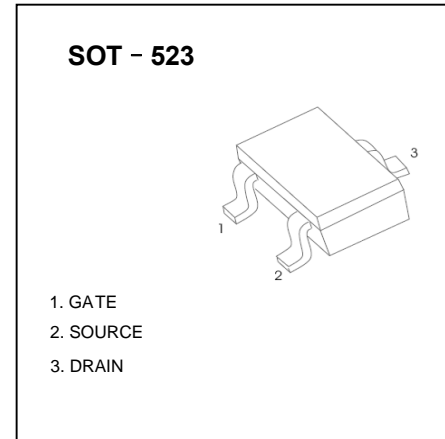
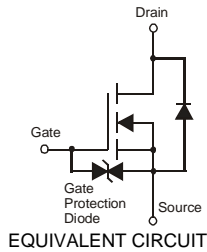

Marking Code: NA1

Maximum Ratings @ $T_A = 25^\circ\text{C}$ unless otherwise specified

Characteristic			Symbol	Value	Units
Drain-Source Voltage			V_{DSS}	20	V
Gate-Source Voltage			V_{GSS}	± 6	V
Continuous Drain Current (Note 1)	Steady State	$T_A = 25^\circ\text{C}$	I_D	0.63	A
		$T_A = 85^\circ\text{C}$		0.45	
Pulsed Drain Current			I_{DM}	6	A

Thermal Characteristics @ $T_A = 25^\circ\text{C}$ unless otherwise specified

Characteristic	Symbol	Value	Units
Total Power Dissipation (Note 1)	P_D	0.28	W
Thermal Resistance, Junction to Ambient	$R_{\theta JA}$	452	$^\circ\text{C}/\text{W}$
Operating and Storage Temperature Range	T_J, T_{STG}	-55 to +150	$^\circ\text{C}$

- Notes: 1. Device mounted on FR-4 PCB.
2. No purposefully added lead.

Electrical Characteristics @ $T_A = 25^\circ\text{C}$ unless otherwise specified

Characteristic	Symbol	Min	Typ	Max	Unit	Test Condition
OFF CHARACTERISTICS (Note 4)						
Drain-Source Breakdown Voltage	BV_{DSS}	20	-	-	V	$V_{GS} = 0V, I_D = 250\mu A$
Zero Gate Voltage Drain Current $T_J = 25^\circ\text{C}$	I_{DSS}	-	-	100	nA	$V_{DS} = 20V, V_{GS} = 0V$
Gate-Source Leakage	I_{GSS}	-	-	± 1.0	μA	$V_{GS} = \pm 4.5V, V_{DS} = 0V$
ON CHARACTERISTICS (Note 4)						
Gate Threshold Voltage	$V_{GS(th)}$	0.5	-	1.0	V	$V_{DS} = V_{GS}, I_D = 250\mu A$
Static Drain-Source On-Resistance	$R_{DS(ON)}$	-	0.3	0.4	Ω	$V_{GS} = 4.5V, I_D = 600mA$
			0.4	0.5		$V_{GS} = 2.5V, I_D = 500mA$
			0.5	0.7		$V_{GS} = 1.8V, I_D = 350mA$
Forward Transfer Admittance	$ Y_{fs} $	-	1.4	-	S	$V_{DS} = 10V, I_D = 400mA$
Diode Forward Voltage (Note 4)	V_{SD}	-	0.7	1.2	V	$V_{GS} = 0V, I_S = 150mA$
DYNAMIC CHARACTERISTICS						
Input Capacitance	C_{iss}	-	60.67	-	pF	$V_{DS} = 16V, V_{GS} = 0V,$ $f = 1.0MHz$
Output Capacitance	C_{oss}	-	9.68	-	pF	
Reverse Transfer Capacitance	C_{rss}	-	5.37	-	pF	
Total Gate Charge	Q_g	-	736.6	-	pC	$V_{GS} = 4.5V, V_{DS} = 10V,$ $I_D = 250mA$
Gate-Source Charge	Q_{gs}	-	93.6	-	pC	
Gate-Drain Charge	Q_{gd}	-	116.6	-	pC	
Turn-On Delay Time	$t_{D(on)}$	-	5.1	-	ns	$V_{DD} = 10V, V_{GS} = 4.5V,$ $R_L = 47\Omega, R_G = 10\Omega,$ $I_D = 200mA$
Turn-On Rise Time	t_r	-	7.4	-	ns	
Turn-Off Delay Time	$t_{D(off)}$	-	26.7	-	ns	
Turn-Off Fall Time	t_f	-	12.3	-	ns	

Notes: 4. Short duration pulse test used to minimize self-heating effect.

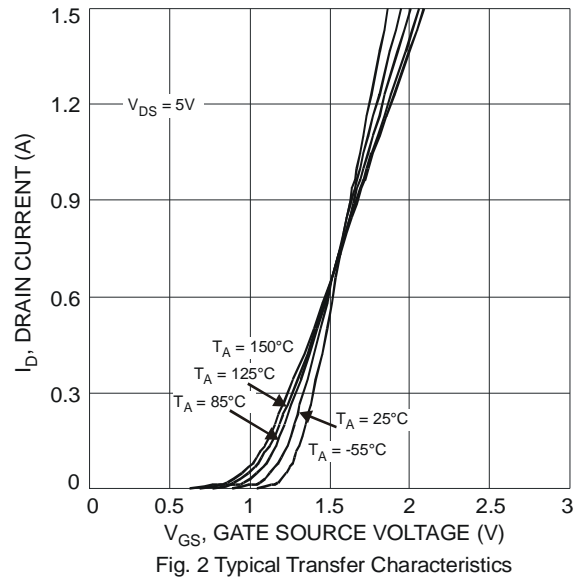
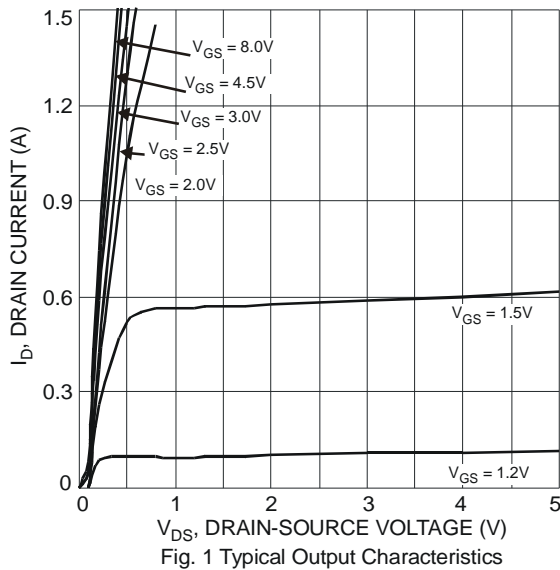

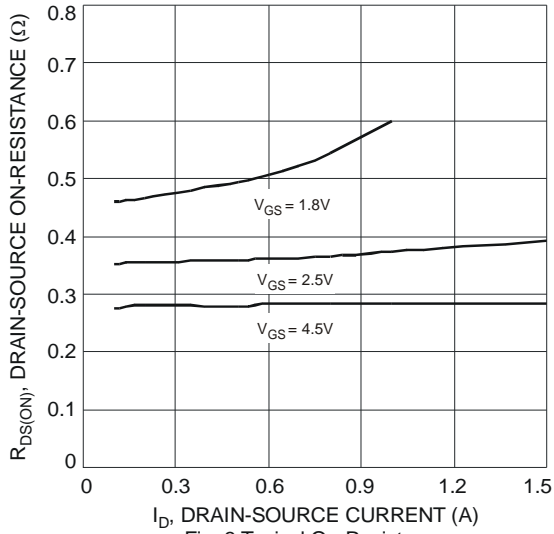

Fig. 3 Typical On-Resistance vs. Drain Current and Gate Voltage

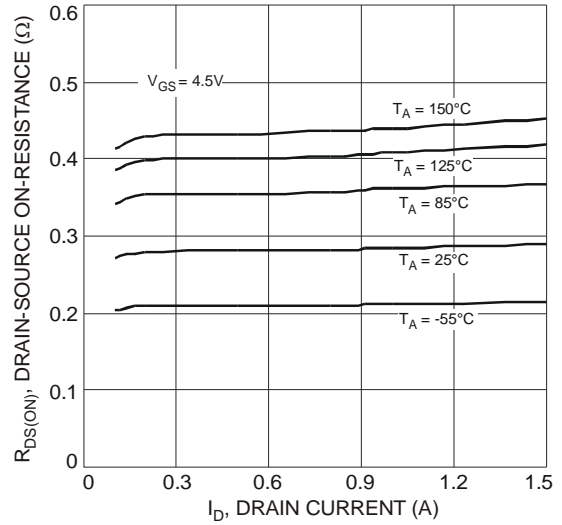

Fig. 4 Typical Drain-Source On-Resistance vs. Drain Current and Temperature

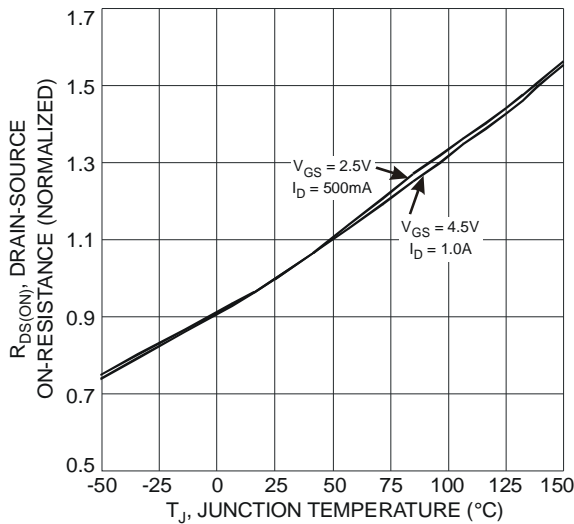

Fig. 5 On-Resistance Variation with Temperature

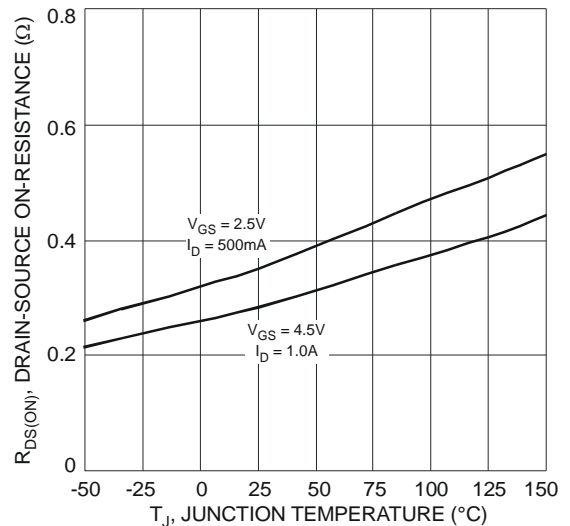

Fig. 6 On-Resistance Variation with Temperature

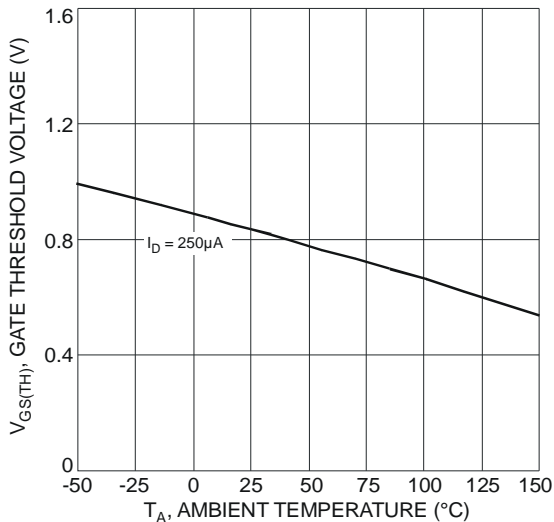

Fig. 7 Gate Threshold Variation vs. Ambient Temperature

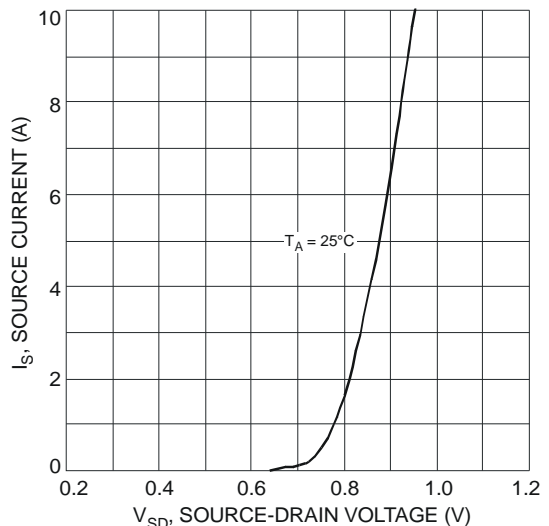

Fig. 8 Diode Forward Voltage vs. Current



CHINA BASE
INTERNATIONAL

SOT-523 BC1012T



www.china-base.com.hk

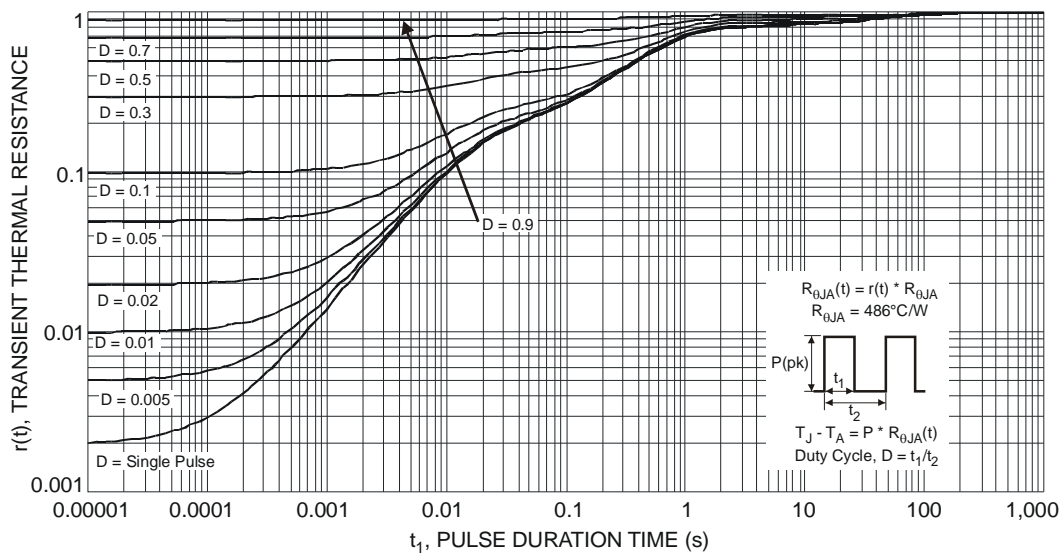
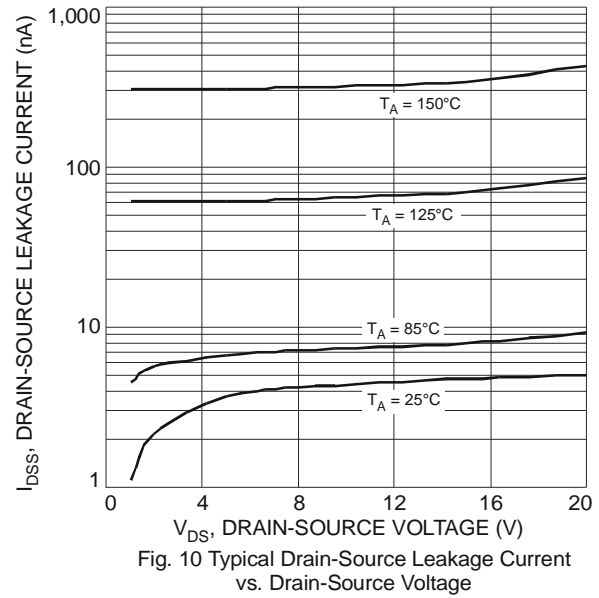
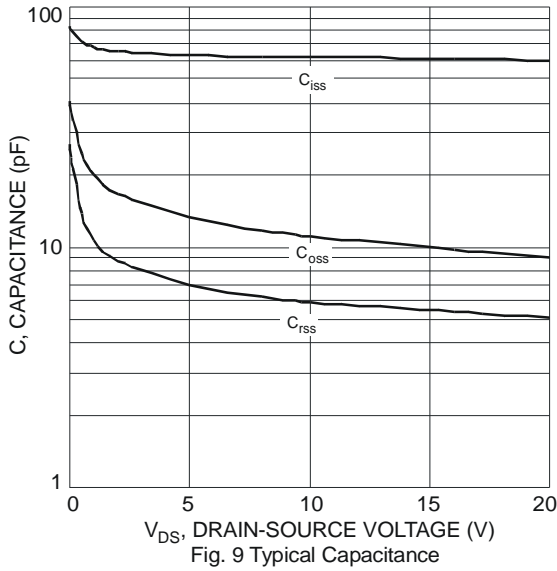

PACKAGE OUTLINE

Plastic surface mounted package; 3 leads

SOT-523

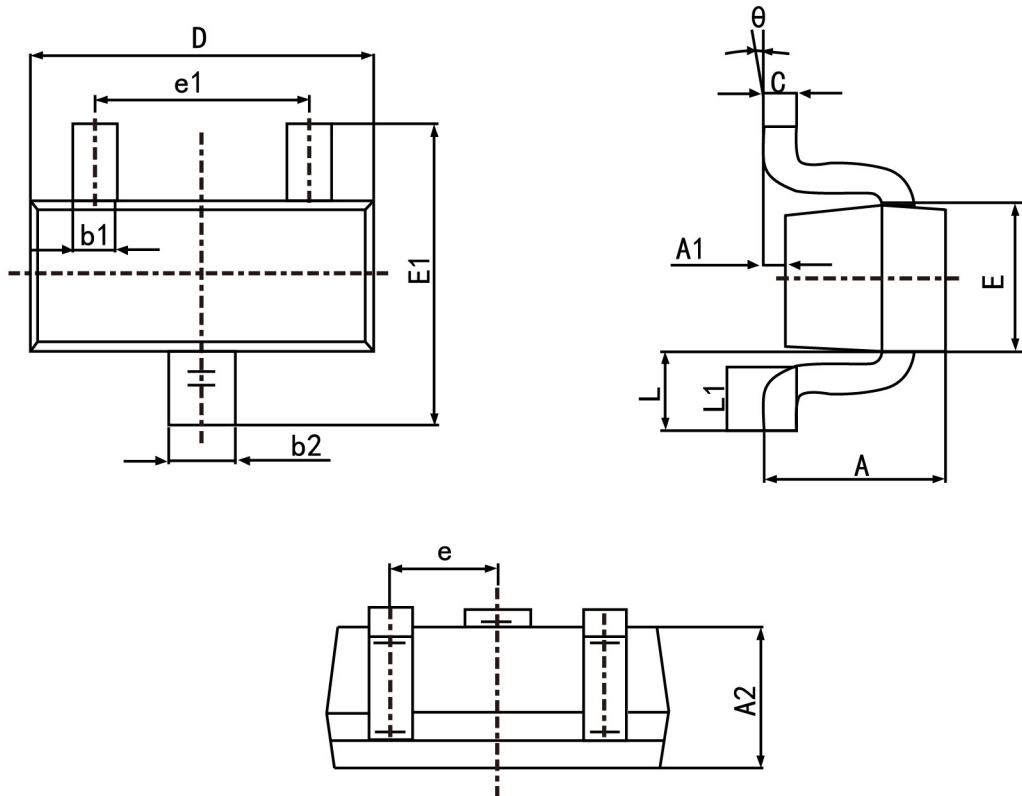

Symbol	Dimension in Millimeters	
	Min	Max
A	0.700	0.900
A1	0.000	0.100
A2	0.700	0.800
b1	0.150	0.250
b2	0.250	0.350
c	0.100	0.200
D	1.500	1.700
E	0.700	0.900
E1	1.450	1.750
e	0.500	TYP.
e1	0.900	1.100
L	0.400 REF.	
L1	0.260	0.460
θ	0°	8°