

Description

The OPA340 series rail-to-rail CMOS operational amplifiers are optimized for low-voltage, single-supply operation. Rail-to-rail input and output and high-speed operation make them ideal for driving sampling analog-to-digital (A/D) converters. They are also well-suited for general purpose and audio applications as well as providing I/V conversion at the output of digital-to-analog (D/A) converters. Single, dual, and quad versions have identical specifications for design flexibility.

The OPA340 series operate on a single supply as low as 2.5 V with an input common-mode voltage range that extends 500 mV below ground and 500 mV above the positive supply. Output voltage swing is to within 1 mV of the supply rails with a 100-kΩ load. These devices offer excellent dynamic response (BW = 5.5 MHz, SR = 6 V/μs), yet quiescent current is only 750 A. Dual and quad designs feature completely independent circuitry for lowest crosstalk and freedom from interaction.

All are specified from -40°C to 85°C and operate from -55°C to 125°C.

Features

- Rail-to-Rail Input
- Rail-to-Rail Output (Within 1 mV)
- MicroSize Packages
- Wide Bandwidth: 5.5 MHz
- High Slew Rate: 6 V/μs
- Low THD + Noise: 0.0007% (f = 1 kHz)
- Low Quiescent Current: 750 μA/Channel
- Single, Dual, and Quad Versions

Applications

- Driving A/D Converters
- PCMCIA Cards
- Data Acquisition
- Process Control
- Audio Processing
- Communications
- Active Filters
- Test Equipment

OPA340 in Noninverting Configuration Driving ADS7816

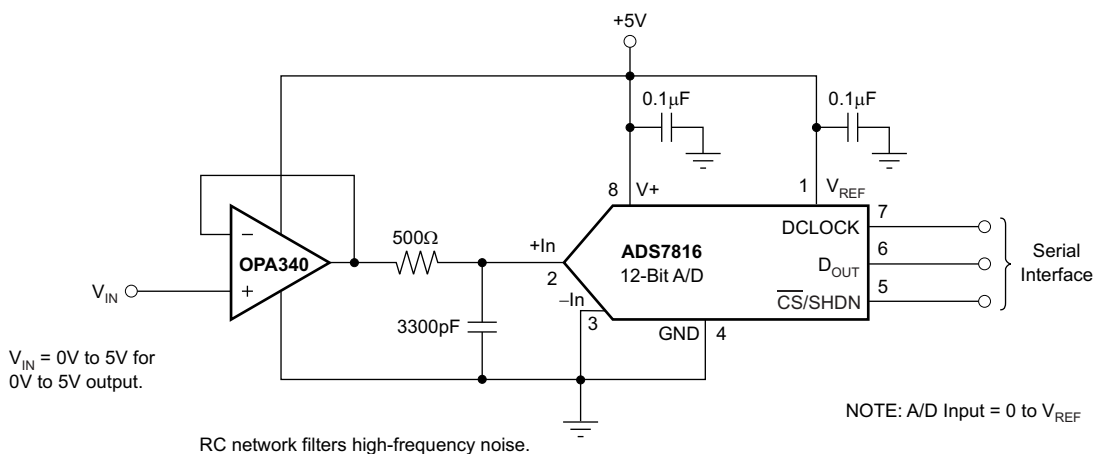

Pin Configuration and Functions

OPA340: 5-Pin SOT-23
Top View

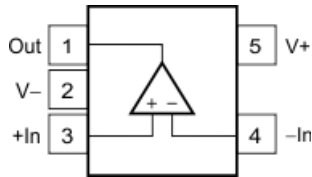

OPA340: 8-Pin SOP-8
Top View

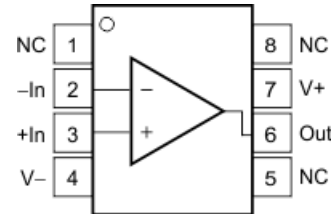

Pin Functions: OPA340

NAME	PIN		I/O	DESCRIPTION
	SOT-23	SOP		
-IN	4	2	I	Negative (inverting) input
+IN	3	3	I	Positive (noninverting) input
NC	—	1, 5, 8	—	No internal connection (can be left floating)
OUT	1	6	O	Output
V-	2	4	—	Negative (lowest) power supply
V+	5	7	—	Positive (highest) power supply

OPA2340: 8-Pin SOP-8
Top View

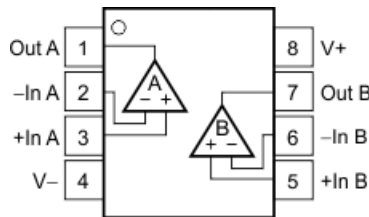

Pin Functions: OPA2340

NAME	PIN		I/O	DESCRIPTION
	SOP			
-IN A	2		I	Negative (inverting) input channel A
+IN A	3		I	Positive (noninverting) input channel A
-IN B	6		I	Negative (inverting) input channel B
+IN B	5		I	Positive (noninverting) input channel B
OUT A	1		O	Output channel A
OUT B	7		O	Output channel B
V-	4		—	Negative (lowest) power supply
V+	8		—	Positive (highest) power supply

OPA4340: Package
SOP-14
Top View

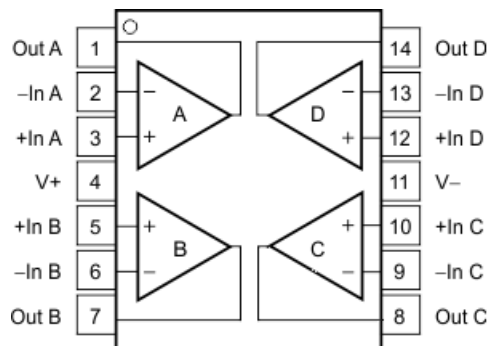

Pin Functions: OPA4340

NAME	PIN SOP	I/O	DESCRIPTION
-IN A	2	I	Negative (inverting) input channel A
-IN B	6	I	Negative (inverting) input channel B
-IN C	9	I	Negative (inverting) input channel C
-IN D	13	I	Negative (inverting) input channel D
+IN A	3	I	Positive (noninverting) input channel A
+IN B	5	I	Positive (noninverting) input channel B
+IN C	10	I	Positive (noninverting) input channel C
+IN D	12	I	Positive (noninverting) input channel D
NC	—	—	No internal connection (can be left floating)
OUT A	1	O	Output, channel A
OUT B	7	O	Output, channel B
OUT C	8	O	Output, channel C
OUT D	14	O	Output, channel D
V-	11	—	Negative (lowest) power supply
V+	4	—	Positive (highest) power supply

Absolute Maximum Ratings

over operating free-air temperature range (unless otherwise noted)⁽¹⁾

		MIN	MAX	UNIT
Voltage	Supply voltage		5.5	V
	Signal input terminals ⁽²⁾	-0.5	0.5	
Current	Signal input terminals ⁽²⁾		10	mA
	Output short circuit ⁽³⁾	Continuous		
Temperature	Operating, T _A	-55	125	°C
	Junction, T _J		150	
	Storage, T _{stg}	-55	125	

- (1) Stresses beyond those listed under Absolute Maximum Ratings may cause permanent damage to the device. These are stress ratings only, which do not imply functional operation of the device at these or any other conditions beyond those indicated under Recommended Operating Conditions. Exposure to absolute-maximum-rated conditions for extended periods may affect device reliability.
- (2) Input terminals are diode-clamped to the power-supply rails. Input signals that can swing more than 0.5 V beyond the supply rails should be current limited to 10 mA or less.
- (3) Short-circuit to ground, one amplifier per package.

ESD Ratings

		VALUE	UNIT
V _(ESD)	Electrostatic discharge	Human-body model (HBM), per ANSI/ESDA/JEDEC JS-001 ⁽¹⁾	±600
		Charged-device model (CDM), per JEDEC specification JESD22-C101 ⁽²⁾	±250

Recommended Operating Conditions

over operating free-air temperature range (unless otherwise noted)

	MIN	MAX	UNIT
Supply voltage	2.7	5.5	V
Specified temperature	-40	125	°C

Thermal Information OPA340

THERMAL METRIC ⁽¹⁾	OPA340			UNIT
	(SOT-23)	(SOP)	(SOP)	
	5 PINS	8 PINS	14 PINS	
R _{θJA} Junction-to-ambient thermal resistance	207.9	142	83.8	°C/W
R _{θJC(top)} Junction-to-case (top) thermal resistance	71.2	90.2	70.7	°C/W
R _{θJB} Junction-to-board thermal resistance	36.0	82.5	59.5	°C/W
ψ _{JT} Junction-to-top characterization parameter	2.0	39.4	11.6	°C/W
ψ _{JB} Junction-to-board characterization parameter	35.2	82	37.7	°C/W
R _{θJC(bot)} Junction-to-case (bottom) thermal resistance	—	—	—	°C/W

Thermal Information – OPA2340

THERMAL METRIC ⁽¹⁾		OPA2340	
		(SOP)	
		8 PINS	
			UNIT
R _{θJA}	Junction-to-ambient thermal resistance	138.4	°C/W
R _{θJC(top)}	Junction-to-case (top) thermal resistance	89.5	°C/W
R _{θJB}	Junction-to-board thermal resistance	78.6	°C/W
ψ _{JT}	Junction-to-top characterization parameter	29.9	°C/W
ψ _{JB}	Junction-to-board characterization parameter	78.1	°C/W
R _{θJC(bot)}	Junction-to-case (bottom) thermal resistance	—	°C/W

Electrical Characteristics

At T_A = 25°C, R_L = 10 kΩ connected to V_S/2, and V_{OUT} = V_S/2, unless otherwise noted.

PARAMETER		TEST CONDITIONS	MIN	TYP ⁽¹⁾	MAX	UNIT
V _{OS}	Input offset voltage	V _S = 5 V		±150	±500	μV
dV _{OS} /dt	Input offset voltage vs temperature	T _A = -40°C to 85°C, V _S = 5 V		±2.5		μV/°C
PSRR	Input offset voltage vs power supply	V _S = 2.7 V to 5.5 V, V _{CM} = 0 V		30	120	μV/V
		Over temperature V _S = 2.7 V to 5.5 V, V _{CM} = 0 V, T _A = -40°C to 85°C, V _S = 5 V			120	μV/°C
Channel separation, DC				0.2		μV/V
I _S	Input bias current			±0.2	±10	pA
		Over temperature	T _A = -40°C to 85°C, V _S = 5 V		±60	
I _{OS}	Input offset current			±0.2	±10	pA
Input voltage noise		f = 0.1 kHz to 50 kHz		8		μV _{RMS}
e _n	Input voltage noise density	f = 1 kHz		25		nV/√Hz
i _n	Current noise density	f = 1 kHz		3		fA/√Hz
V _{CM}	Common-mode voltage range		-0.3		(V+) + 0.3	V
CMRR	Common-mode rejection ratio	-0.3 V < V _{CM} < (V+) - 1.8 V	80	92		dB
		V _S = 5 V, -0.3 V < V _{CM} < 5.3 V	70	84		
		V _S = 2.7 V, -0.3 V < V _{CM} < 3 V	66	80		

(1) V_S = 5 V.

Electrical Characteristics (continued)

At $T_A = 25^\circ\text{C}$, $R_L = 10\text{ k}\Omega$ connected to $V_S/2$, and $V_{OUT} = V_S/2$, unless otherwise noted.

PARAMETER		TEST CONDITIONS	MIN	TYP ⁽¹⁾	MAX	UNIT	
Differential				$10^{13} \parallel 3$		$\Omega \parallel \text{pF}$	
Common-mode				$10^{13} \parallel 6$		$\Omega \parallel \text{pF}$	
A _{OL}	Open-loop voltage gain	R _L = 100 kΩ, 5 mV < V _O < (V+) – 5 mV	106	124		dB	
		R _L = 10 kΩ, 5 mV < V _O < (V+) – 50 mV	100	120			
		R _L = 2 kΩ, 200 mV < V _O < (V+) – 200 mV	94	114			
		Over temperature	R _L = 100 kΩ, 5 mV < V _O < (V+) – 5 mV, T _A = –40°C to 85°C, V _S = 5 V	106			
			R _L = 10 kΩ, 5 mV < V _O < (V+) – 50 mV, T _A = –40°C to 85°C, V _S = 5 V	100			
			R _L = 2 kΩ, 200 mV < V _O < (V+) – 200 mV, T _A = –40°C to 85°C, V _S = 5 V	94			
GBW	Gain-bandwidth product	G = 1		5.5		MHz	
SR	Slew rate	V _S = 5 V, G = 1, C _L = 100 pF		6		V/μs	
	Settling time, 0.1%	V _S = 5 V, 2-V step, C _L = 100 pF		1		μs	
	Settling time, 0.01%	V _S = 5 V, 2-V step, C _L = 100 pF		1.6		μs	
	Overload recovery time	V _{IN} × G = V _S		0.2		μs	
THD+N	Total harmonic distortion + noise	V _S = 5 V, V _O = 3V _{PP} ⁽²⁾ , G = 1, f = 1 kHz		0.0007%			
	Voltage output swing from rail ⁽²⁾	R _L = 100 kΩ, A _{OL} ≥ 106 dB		1	5	mV	
		R _L = 10 kΩ, A _{OL} ≥ 106 dB		10			
		R _L = 2 kΩ, A _{OL} ≥ 106 dB		40			
		Over temperature	R _L = 100 kΩ, A _{OL} ≥ 106 dB, T _A = –40°C to 85°C, V _S = 5 V				5
			R _L = 10 kΩ, A _{OL} ≥ 106 dB, T _A = –40°C to 85°C, V _S = 5 V				50
			R _L = 2 kΩ, A _{OL} ≥ 106 dB, T _A = –40°C to 85°C, V _S = 5 V				200
I _{SC}	Short-circuit current			±50		mA	
C _{LOAD}	Capacitive load drive		See Typical Characteristics				
V _S	Specified voltage range		2.7		5	V	
	Operating voltage range	Lower end		2.5		V	
		Higher end		5.5			
I _Q	Quiescent current (per amplifier)	I _O = 0, V _S = 5 V		750	950	μA	
		Over temperature	I _O = 0, V _S = 5 V, T _A = –40°C to 85°C				100
	Specified range		–40		85	°C	
	Operating range		–55		125	°C	
	Storage range		–55		125	°C	

(2) Output voltage swings are measured between the output and power-supply rails.

Typical Characteristics

At $T_A = 25^\circ\text{C}$, $V_S = 5\text{ V}$, and $R_L = 10\text{ k}\Omega$ connected to $V_S/2$, unless otherwise noted.

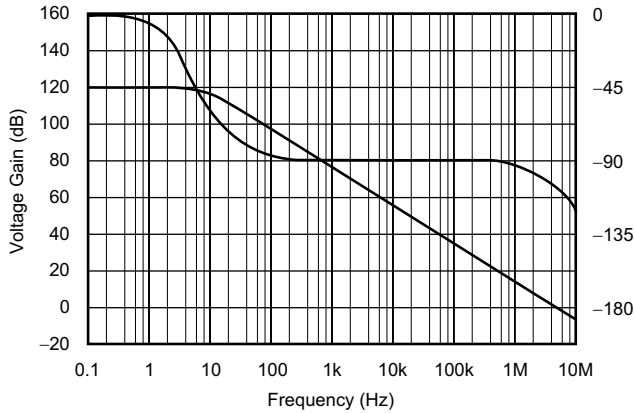

Figure 1. Open-Loop Gain/Phase vs Frequency

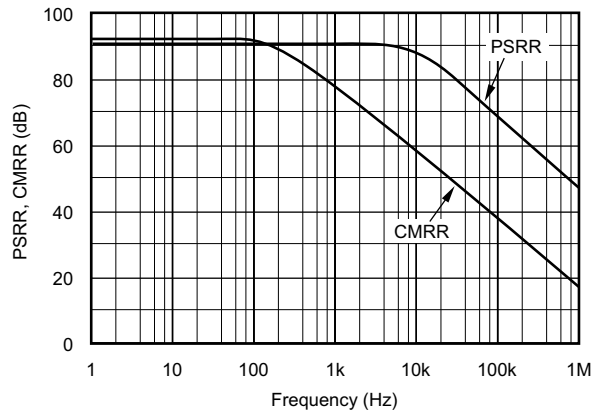

Figure 2. Power-Supply and Common-Mode Rejection vs Frequency

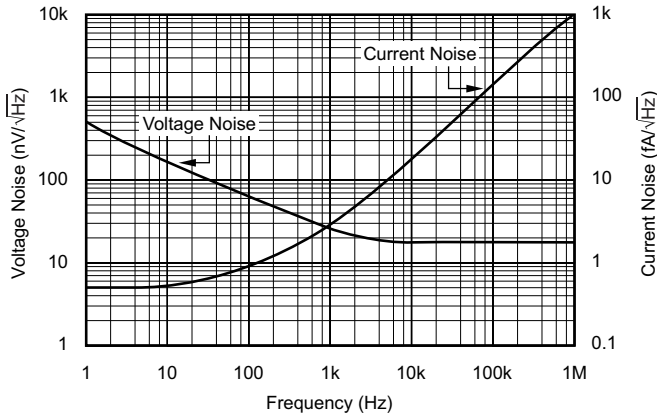

Figure 3. Input Voltage and Current Noise Spectral Density vs Frequency

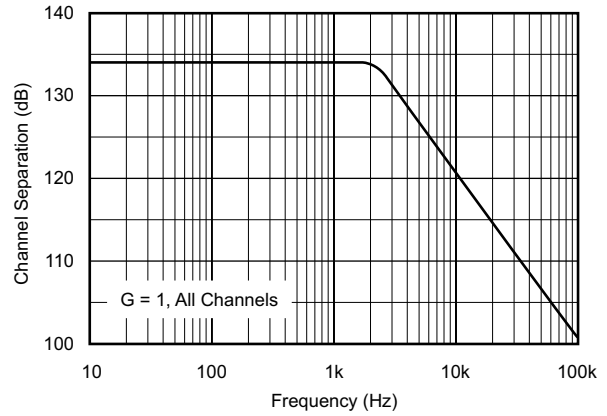

Figure 4. Channel Separation vs Frequency

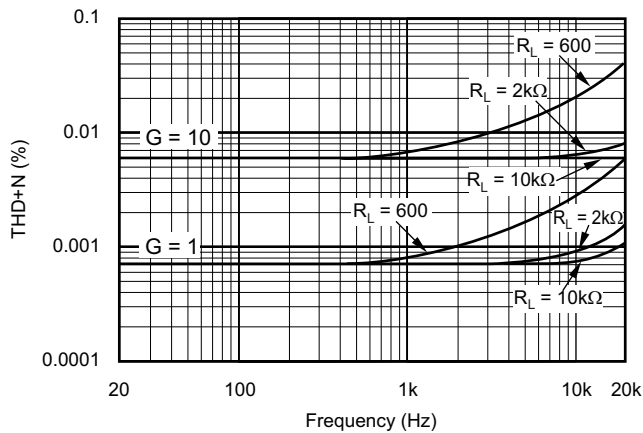

Figure 5. Total Harmonic Distortion + Noise vs Frequency

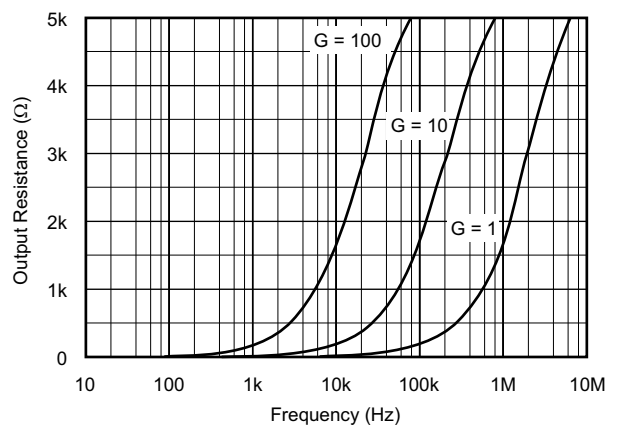

Figure 6. Closed-Loop Output Impedance vs Frequency

Typical Characteristics

At $T_A = 25^\circ\text{C}$, $V_S = 5\text{ V}$, and $R_L = 10\text{ k}\Omega$ connected to $V_S/2$, unless otherwise noted.

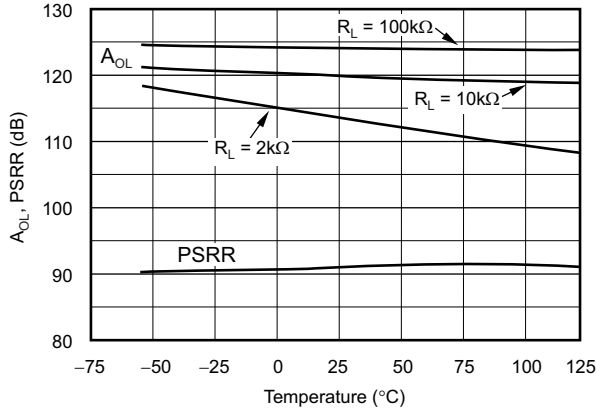

Figure 7. Open-Loop Gain and Power-Supply Rejection vs Temperature

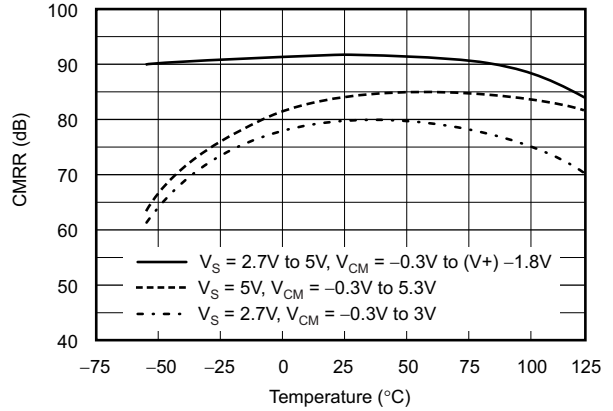

Figure 8. Common-Mode Rejection vs Temperature

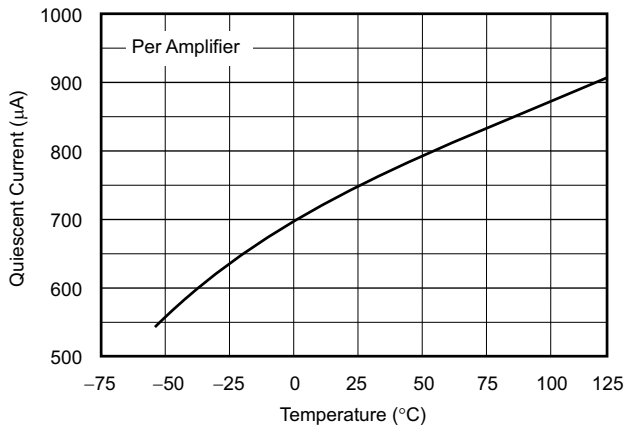

Figure 9. Quiescent Current vs Temperature

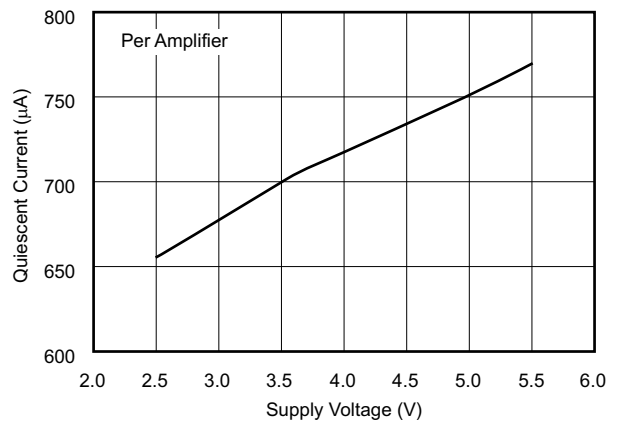

Figure 10. Quiescent Current vs Supply Voltage

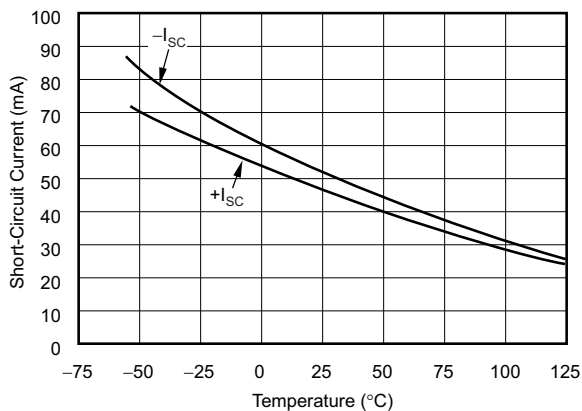

Figure 11. Short-Circuit Current vs Temperature

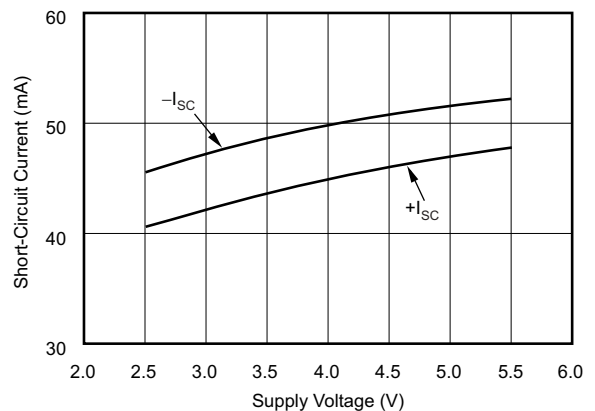

Figure 12. Short-Circuit Current vs Supply Voltage

Typical Characteristics

At $T_A = 25^\circ\text{C}$, $V_S = 5\text{ V}$, and $R_L = 10\text{ k}\Omega$ connected to $V_S/2$, unless otherwise noted.

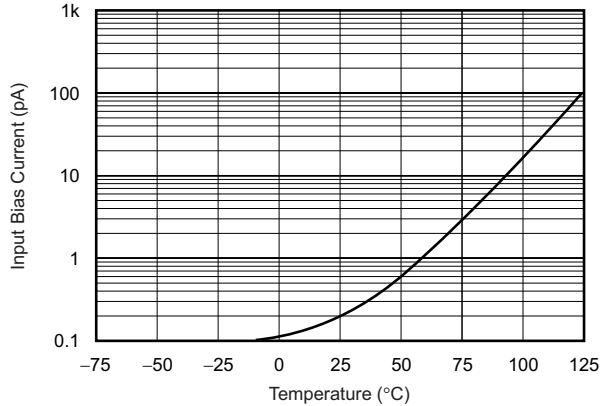

Figure 13. Input Bias Current vs Temperature

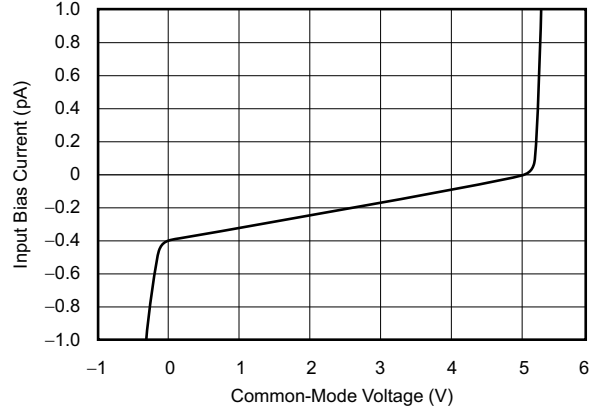

Figure 14. Input Bias Current vs Input Common-Mode Voltage

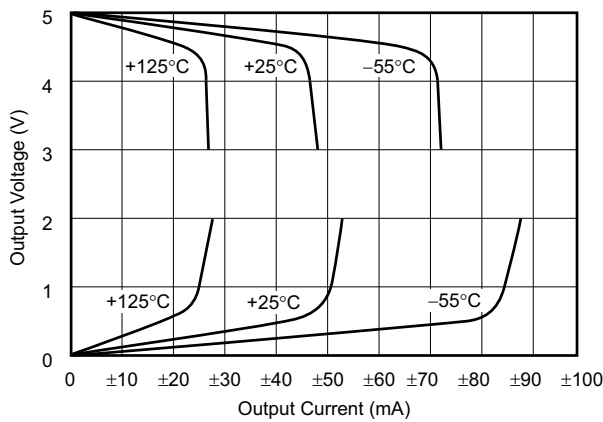

Figure 15. Output Voltage Swing vs Output Current

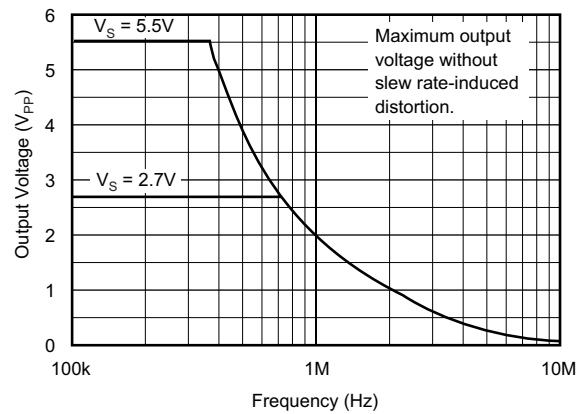

Figure 16. Maximum Output Voltage vs Frequency

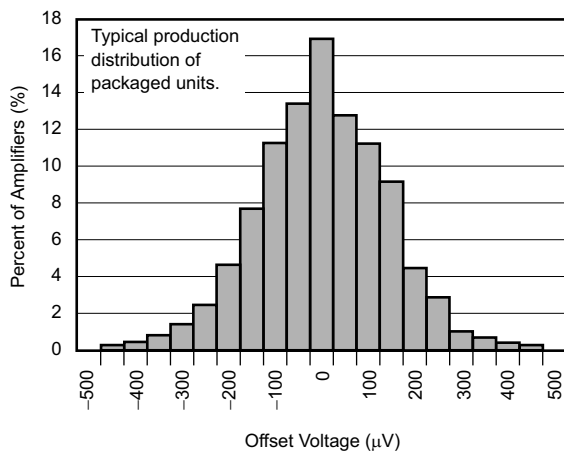

Figure 17. Offset Voltage Production Distribution

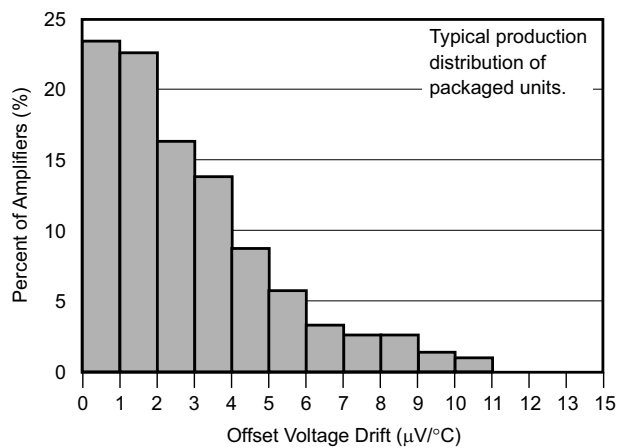
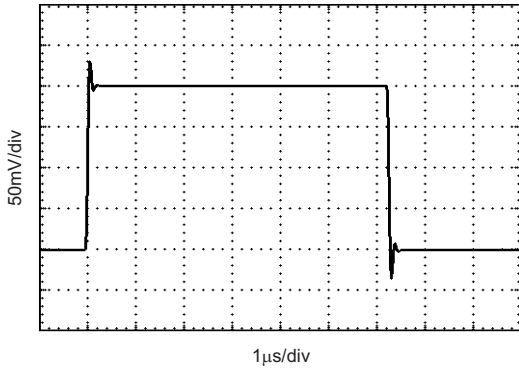

Figure 18. Offset Voltage Drift Magnitude Production Distribution

Typical Characteristics

At $T_A = 25^\circ\text{C}$, $V_S = 5\text{ V}$, and $R_L = 10\text{ k}\Omega$ connected to $V_S/2$, unless otherwise noted.



$C_L = 100\text{ pF}$

Figure 19. Small-Signal Step Response

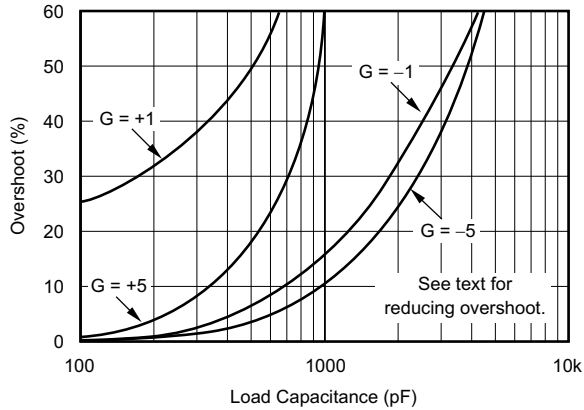
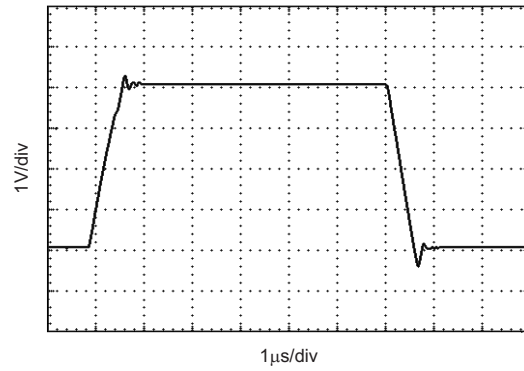

Figure 21. Small-Signal Overshoot vs Load Capacitance



$C_L = 100\text{ pF}$

Figure 20. Large-Signal Step Response

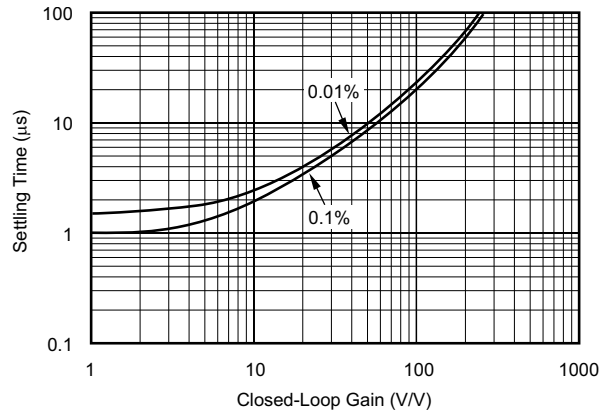
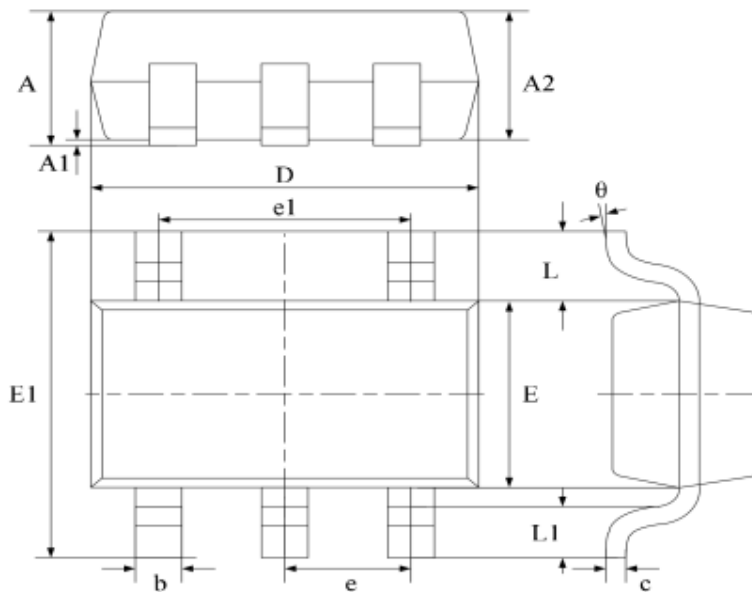

Figure 22. Settling Time vs Closed-Loop Gain

Package Dimension

SOT23-5



Symbol	Dimensions In Millimeters		Dimensions In Inches	
	Min	Max	Min	Max
A	1.040	1.350	0.042	0.055
A1	0.040	0.150	0.002	0.006
A2	1.000	1.200	0.041	0.049
b	0.380	0.480	0.015	0.020
c	0.110	0.210	0.004	0.009
D	2.720	3.120	0.111	0.127
E	1.400	1.800	0.057	0.073
E1	2.600	3.000	0.106	0.122
e	0.950 typ.		0.037 typ.	
e1	1.900 typ.		0.078 typ.	
L	0.700 ref.		0.028 ref.	
L1	0.300	0.600	0.012	0.024
θ	0°	8°	0°	8°

SOP-14

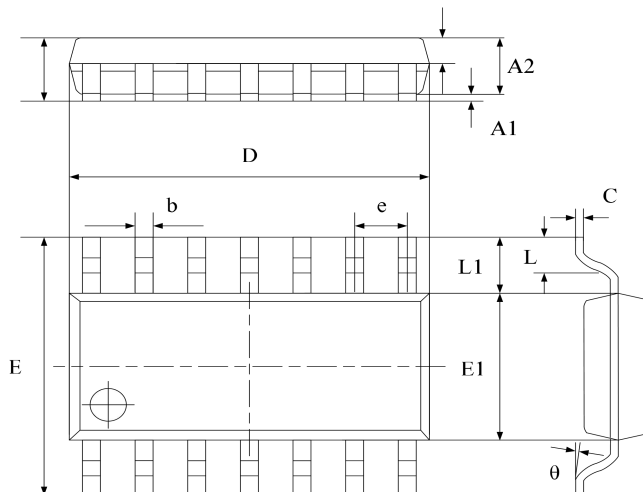

Symbol	Dimensions In Millimeters		Dimensions In Inches	
	Min	Max	Min	Max
A	1.450	1.850	0.059	0.076
A1	0.100	0.300	0.004	0.012
A2	1.350	1.550	0.055	0.063
A3	0.550	0.750	0.022	0.031
b	0.406typ.		0.017typ.	
C	0.203typ.		0.008typ.	
D	8.630	8.830	0.352	0.360
E	5.840	6.240	0.238	0.255
E1	3.850	4.050	0.157	0.165
e	1.270 typ.		0.050 typ.	
L1	1.040 ref.		0.041 ref.	
L	0.350	0.750	0.014	0.031
θ	2°	8°	2°	8°

SOP-8

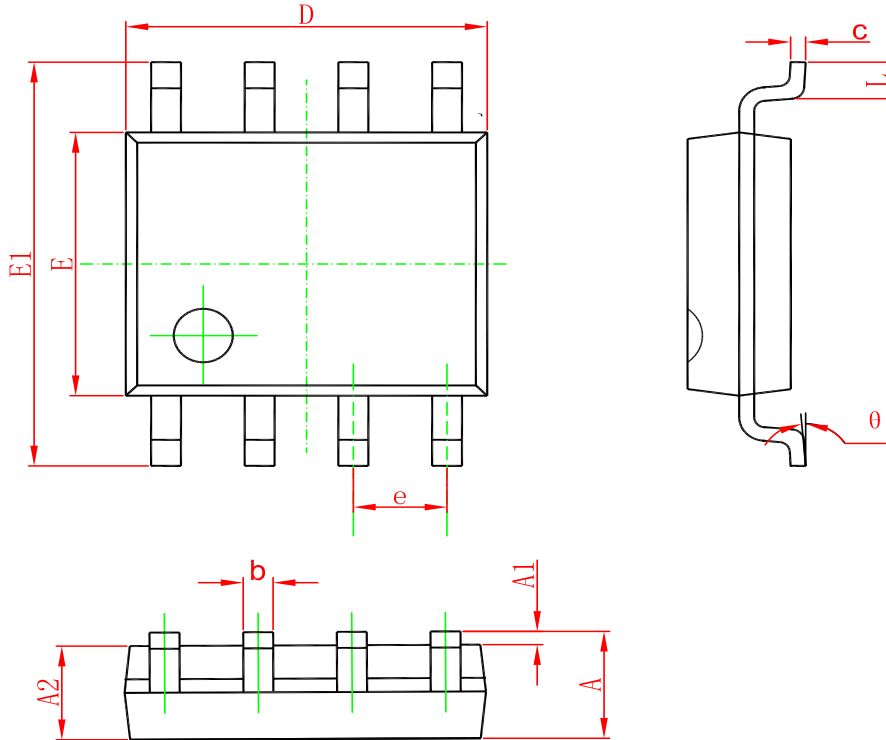

Symbol	Dimensions In Millimeters		Dimensions In Inches	
	Min	Max	Min	Max
A	1.350	1.750	0.053	0.069
A1	0.100	0.250	0.004	0.010
A2	1.350	1.550	0.053	0.061
b	0.330	0.510	0.013	0.020
c	0.170	0.250	0.006	0.010
D	4.700	5.100	0.185	0.200
E	3.800	4.000	0.150	0.157
E1	5.800	6.200	0.228	0.244
e	1.270(BSC)		0.050(BSC)	
L	0.400	1.270	0.016	0.050
θ	0°	8°	0°	8°

Ordering information

Order code	Package	Baseqty	Deliverymode	Marking
UMW OPA4340UA	SOP-14	2500	Tape and reel	OPA4340UA
UMW OPA2340UA	SOP-8	2500	Tape and reel	OPA2340UA
UMW OPA340UA	SOP-8	2500	Tape and reel	OPA340UA
UMW OPA340NA	SOT23-5	3000	Tape and reel	A40 U