

EVALUATION KIT
AVAILABLE

MAXIM

W-CDMA LNA/Mixer ICs

MAX2387/MAX2388/MAX2389

General Description

The MAX2387/MAX2388/MAX2389 low-noise amplifier (LNA), downconverter mixers designed for W-CDMA applications, are ideal for ARIB (Japan) and ETSI-UMTS (Europe) based systems. The MAX2387/MAX2388/MAX2389 feature ultra-low current consumption and exceptionally low noise figures in ultra-small packages.

The MAX2387/MAX2388 include an LNA, a downconverter mixer, and a local-oscillator (LO) buffer. The MAX2389 has an LNA and mixer, but minimizes current consumption by omitting the LO buffer. For all devices, the LNA and downconverter mixers are optimized for the 2110MHz to 2170MHz band. All devices feature a high-gain mode and a low-gain mode of LNA operation. The MAX2387 has a 32dB gain step, and the MAX2388/MAX2389 have an 18dB gain step. All ICs include a shutdown mode, powering down the IC during the front-end receiver's idle periods.

The mixer 3rd-order nonlinearity performance is set using an external biasing resistor. For the MAX2387/MAX2388, mixer performance is optimized for a -10dBm typical drive at the LO buffer input port. The MAX2389 mixer performance is optimized for a -4dBm typical drive at the LO input port. The LO port for all versions is configurable for either single-ended or differential operation.

These devices operate from a +2.7V to +3.3V single supply and are available in ultra-small (3mm × 3mm) 12-pin leadless packages (QFN).

Applications

Japanese 3rd-Generation W-CDMA Cellular Phones

Dual-Mode W-CDMA/GSM Cellular Phones

Features

- ◆ Ultra-Low Current Consumption: 10.7mA (MAX2387), 9.9mA (MAX2388), and 7.9mA (MAX2389)
- ◆ +2.7V to +3.3V Single-Supply Operation
- ◆ Mixer NF: 7dB SSB
- ◆ Cascaded Noise Figure: 2.3dB
- ◆ LNA Low-Gain Mode: 32dB Gain Step (MAX2387) or 18dB Gain Step (MAX2388/MAX2389)
- ◆ Mixer IIP3: 6dBm
- ◆ < 1μA Shutdown Current
- ◆ Ultra-Small (3mm × 3mm) 12-Pin QFN Package

Ordering Information

PART	TEMP. RANGE	PIN-PACKAGE
MAX2387EGC	-40°C to +85°C	12 QFN
MAX2388EGC	-40°C to +85°C	12 QFN
MAX2389EGC	-40°C to +85°C	12 QFN

Pin Descriptions/Functional Diagrams

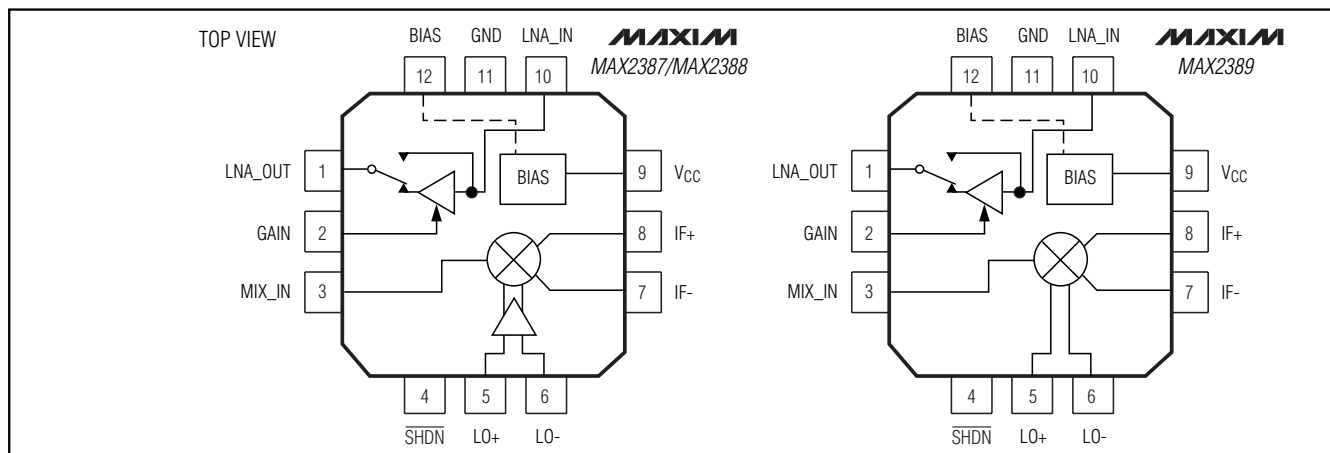

MAXIM

Maxim Integrated Products 1

For pricing, delivery, and ordering information, please contact Maxim/Dallas Direct! at 1-888-629-4642, or visit Maxim's website at www.maxim-ic.com.

W-CDMA LNA/Mixer ICs

ABSOLUTE MAXIMUM RATINGS

V_{CC} to GND-0.3V to +4.3V
 $\overline{\text{SHDN}}$, GAIN to GND-0.3V to (V_{CC} + 0.3V)
 AC Signals+1V peak
 Digital Input Current±10mA
 Continuous Power Dissipation (T_A = +70°C)
 12-Pin QFN (derate 11.9mW/°C above T_A = +70°C)...952mW

Operating Temperature Range-40°C to +85°C
 Junction Temperature+150°C
 Storage Temperature Range-65°C to +150°C
 Soldering Temperature (10s).....+300°C

Stresses beyond those listed under "Absolute Maximum Ratings" may cause permanent damage to the device. These are stress ratings only, and functional operation of the device at these or any other conditions beyond those indicated in the operational sections of the specifications is not implied. Exposure to absolute maximum rating conditions for extended periods may affect device reliability.

DC ELECTRICAL CHARACTERISTICS

(V_{CC} = +2.7V to +3.3V, $\overline{\text{SHDN}}$ = high, R_{BIAS} = 24kΩ, no input AC signals, T_A = -40°C to +85°C. Typical values are at V_{CC} = +2.7V, T_A = +25°C, unless otherwise noted.)

PARAMETER	SYMBOL	CONDITIONS	MIN	TYP	MAX	UNITS
Operating Supply Current	I _{CC}	High-gain mode	MAX2387	10.7	12.4	mA
			MAX2388	9.9	11.7	
			MAX2389	7.9	9.3	
		Low-gain mode	MAX2387	7.2	8.7	
			MAX2388	6.7	8.1	
			MAX2389	4.7	5.7	
Shutdown Supply Current	I _{CC}	$\overline{\text{SHDN}}$ = low	0.2	1.0	μA	
Digital Input Logic High	V _{IH}		2.0		V	
Digital Input Logic Low	V _{IL}			0.6	V	
Input Logic High Current	I _{IH}	V _{IN} = V _{IH}			1	μA
Input Logic Low Current	I _{IL}	V _{IN} = V _{IL}	-20			μA

AC ELECTRICAL CHARACTERISTICS

(MAX238_ EV kit, V_{CC} = 2.7V, $\overline{\text{SHDN}}$ = high, f_{RF_IN} = f_{LNA_IN} = 2140MHz, f_{LO} = 2330MHz (f_{IF} = 190MHz). Mixer, LNA, and LO input ports are driven with 50Ω sources. R_{BIAS} = 24kΩ ±1%, P_{LO} = -10dBm (MAX2387/MAX2388), P_{LO} = -4dBm (MAX2389), P_{RF} = -30dBm. Typical values are at V_{CC} = +2.7V, T_A = +25°C, unless otherwise noted.)

PARAMETER	SYMBOL	CONDITIONS	MIN	TYP	MAX	UNITS
LNA PERFORMANCE: LOW-GAIN MODE (GAIN = HIGH)						
RF Frequency Range (Note 1)	f _{RF}		2110		2170	MHz
Gain	G _{LNA}	T _A = +25°C	13.5	15	16.5	dB
		T _A = -40°C to +85°C (Note 2)	12.9		17.0	

W-CDMA LNA/Mixer ICs

MAX2387/MAX2388/MAX2389

AC ELECTRICAL CHARACTERISTICS (continued)

(MAX238_EV kit, $V_{CC} = 2.7V$, $\overline{SHDN} = \text{high}$, $f_{RF_IN} = f_{LNA_IN} = 2140\text{MHz}$, $f_{LO} = 2330\text{MHz}$ ($f_{IF} = 190\text{MHz}$). Mixer, LNA, and LO input ports are driven with 50Ω sources. $R_{BIAS} = 24k\Omega \pm 1\%$, $P_{LO} = -10\text{dBm}$ (MAX2387/MAX2388), $P_{LO} = -4\text{dBm}$ (MAX2389), $P_{RF} = -30\text{dBm}$. Typical values are at $V_{CC} = +2.7V$, $T_A = +25^\circ\text{C}$, unless otherwise noted.)

PARAMETER	SYMBOL	CONDITIONS	MIN	TYP	MAX	UNITS	
Noise Figure (Notes 1, 3)	N_{FLNA}	$T_A = +25^\circ\text{C}$		1.7	2.2	dB	
3rd-Order Input Intercept Point (Note 4)	$IIP3_{LNA}$	$T_A = -40^\circ\text{C}$ to $+85^\circ\text{C}$ (Note 2)		4.2		dBm	
Input -1dB Compression Point (Note 1)	IP-1dB		-19	-13		dBm	
LNA PERFORMANCE: LOW-GAIN MODE (GAIN = LOW)							
Gain	G_{LNA}	$T_A = +25^\circ\text{C}$	MAX2387	-18.5	-16.5	-14.5	dB
			MAX2388/ MAX2389	-4.7	-2.8	-0.9	
		$T_A = -40^\circ\text{C}$ to $+85^\circ\text{C}$ (Note 2)	MAX2387	-10.5		-14	
			MAX2388/ MAX2389	5.4		-0.7	
Noise Figure (Notes 1, 3)	N_{FLNA}		MAX2387		19.2	21.3	dB
			MAX2388/ MAX2389		6.5	8.4	
3rd-Order Input Intercept Point (Note 5)	$IIP3_{LNA}$		MAX2387		1		dBm
			MAX2388/ MAX2389		3.4		
Input -1dB Compression Point	IP-1dB		MAX2387		-9.9		dBm
			MAX2388/ MAX2389		-7.7		
MIXER PERFORMANCE (GAIN = HIGH)							
RF Frequency Range (Note 1)	f_{RF}		2110		2170	MHz	
LO Frequency Range (Note 1)	f_{LO}		2250		2600	MHz	
IF Frequency Range (Note 1)	f_{IF}		150		400	MHz	
Power Conversion Gain	G_{MXR}	$T_A = +25^\circ\text{C}$		8.5	10	11.5	dB
		$T_A = -40^\circ\text{C}$ to $+85^\circ\text{C}$ (Note 2)		7.5		12.5	
Noise Figure (SSB) (Note 1)	N_{FMXR}	$T_A = +25^\circ\text{C}$	MAX2387		7.2	8.8	dB
			MAX2388		6.8	8.2	
			MAX2389		7.3	9.5	

W-CDMA LNA/Mixer ICs

MAX2387/MAX2388/MAX2389

AC ELECTRICAL CHARACTERISTICS (continued)

(MAX238_EV kit, $V_{CC} = 2.7V$, $\overline{SHDN} = \text{high}$, $f_{RF_IN} = f_{LNA_IN} = 2140\text{MHz}$, $f_{LO} = 2330\text{MHz}$ ($f_{IF} = 190\text{MHz}$). Mixer, LNA, and LO input ports are driven with 50Ω sources. $R_{BIAS} = 24k\Omega \pm 1\%$, $P_{LO} = -10\text{dBm}$ (MAX2387/MAX2388), $P_{LO} = -4\text{dBm}$ (MAX2389), $P_{RF} = -30\text{dBm}$. Typical values are at $V_{CC} = +2.7V$, $T_A = +25^\circ\text{C}$, unless otherwise noted.)

PARAMETER	SYMBOL	CONDITIONS	MIN	TYP	MAX	UNITS
3rd-Order Input Intercept Point (Notes 1, 3)	IIP3 _{MXR}		MAX2387	6		dBm
			MAX2388	6		
			MAX2389	5		
Input -1dB Compression Point (Note 1)	IP-1dB _{MXR}	$T_A = -40^\circ\text{C}$ to $+85^\circ\text{C}$	MAX2387	-13.9	-10	dBm
			MAX2388	-16.3	-10.5	
			MAX2389	-15.4	-10.5	
MIXER PERFORMANCE (GAIN = LOW)						
Power Conversion Gain (Note 1)	GMXR	$T_A = +25^\circ\text{C}$	7.5	9.0	10.5	dB
		$T_A = -40^\circ\text{C}$ to $+85^\circ\text{C}$	6.5		12.0	
Noise Figure (SSB) (Note 1)	NF _{MXR}	$T_A = +25^\circ\text{C}$	MAX2387	6.9	8.4	dB
			MAX2388	6.1	7.4	
			MAX2389	6.6	8.8	
3rd-Order Input Intercept Point (Note 4)	IIP3 _{MXR}	$T_A = +25^\circ\text{C}$	MAX2387	0.7		dBm
			MAX2388	0.2		
			MAX2389	1.3		
Input -1dB Compression Point (Note 1)	IP-1dB _{MXR}	$T_A = -40^\circ\text{C}$ to $+85^\circ\text{C}$	MAX2387	-15.0	-10.7	dBm
			MAX2388	-18.2	-11.3	
			MAX2389	-17.8	-11.9	

Note 1: Guaranteed by design and characterization.

Note 2: MIN guaranteed by production test, MAX guaranteed by design and characterization.

Note 3: Includes input matching circuit loss.

Note 4: $f_{IN1} = 2140\text{MHz}$, $f_{IN2} = 2141\text{MHz}$, $P_{IN} = -30\text{dBm}$ per tone.

Note 5: $f_{IN1} = 2140\text{MHz}$, $f_{IN2} = 2141\text{MHz}$, $P_{IN} = -25\text{dBm}$ per tone.

W-CDMA LNA/Mixer ICs

Typical Operating Characteristics

($T_A = +25^\circ\text{C}$, $V_{CC} = +2.7\text{V}$, unless otherwise noted.)

MAX2387/MAX2388/MAX2389

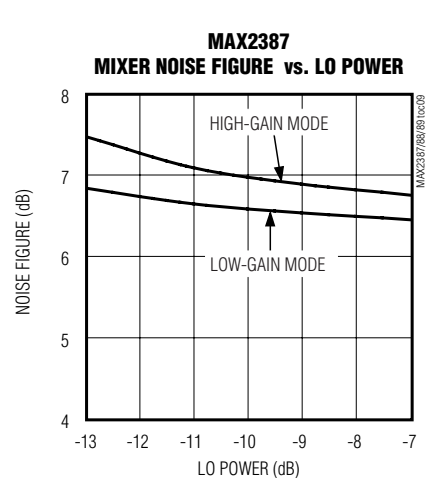
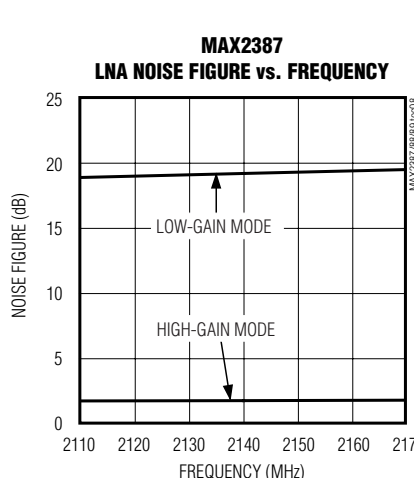
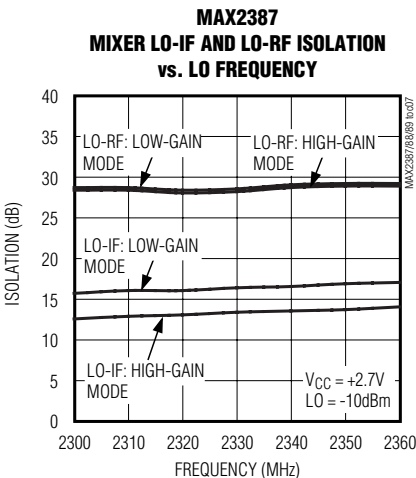
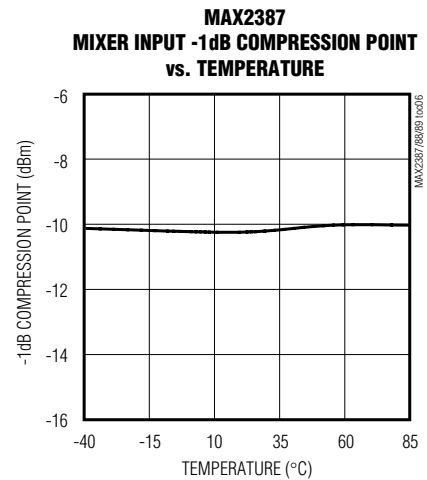
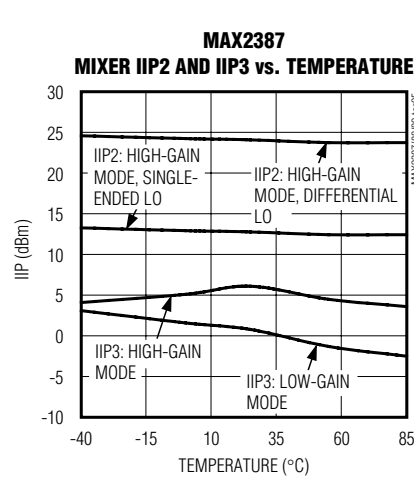
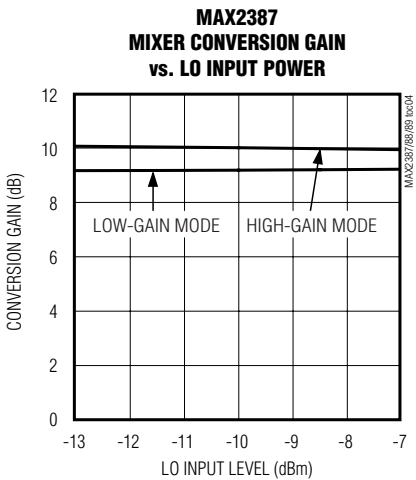
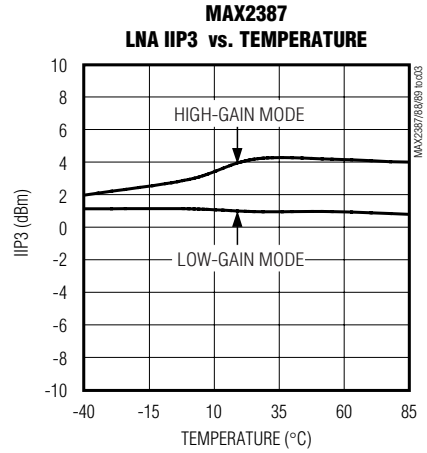
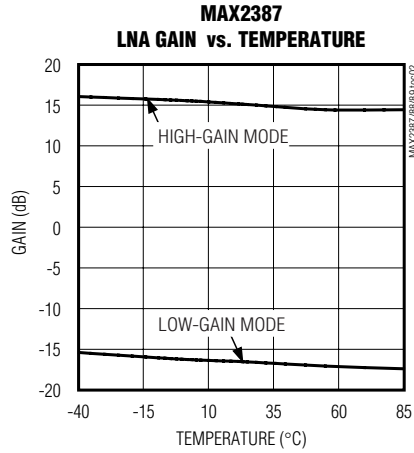
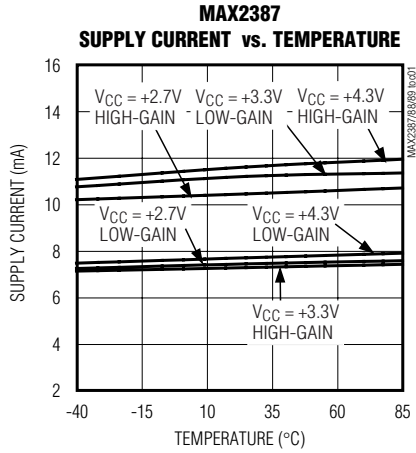

W-CDMA LNA/Mixer ICs

Typical Operating Characteristics (continued)

($T_A = +25^\circ\text{C}$, $V_{CC} = +2.7\text{V}$, unless otherwise noted.)

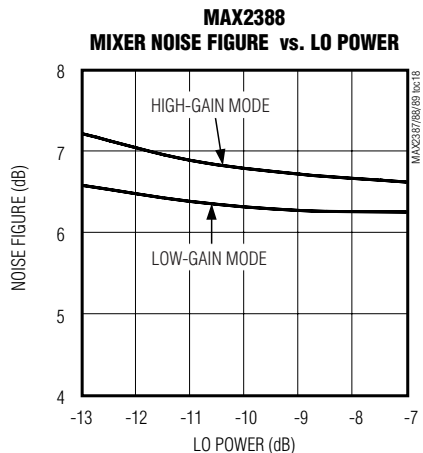
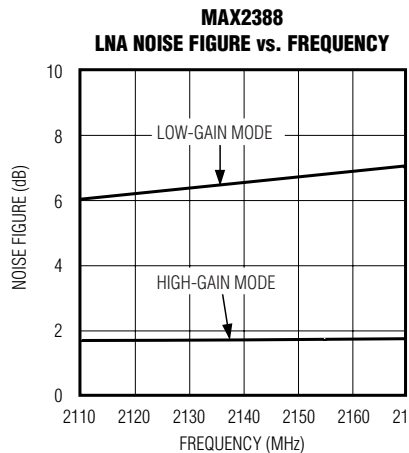
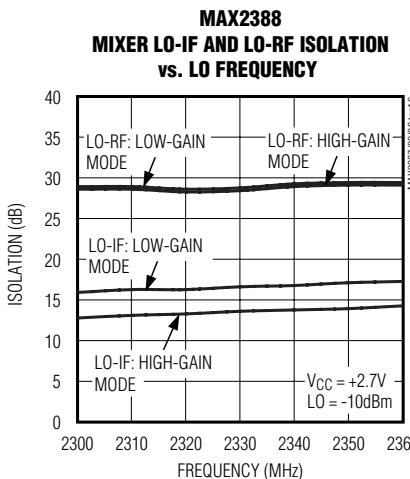
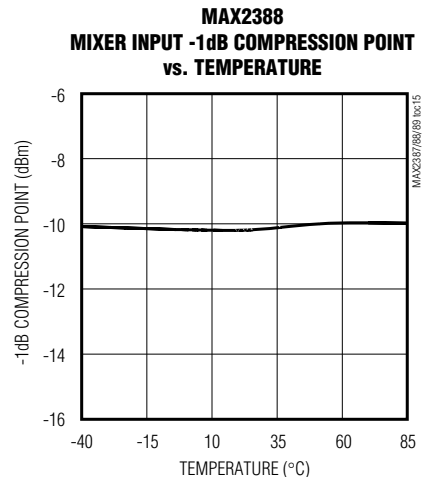
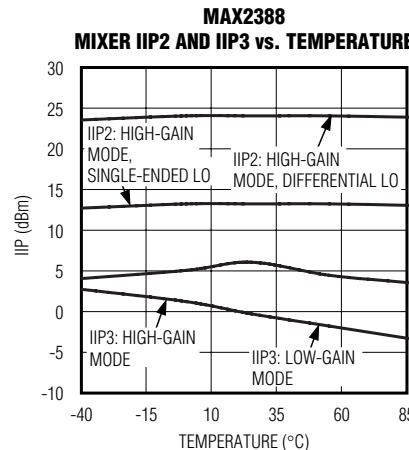
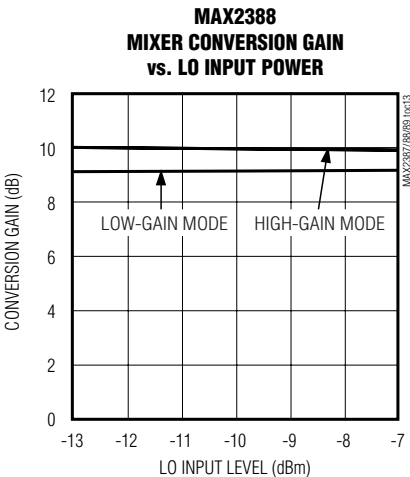
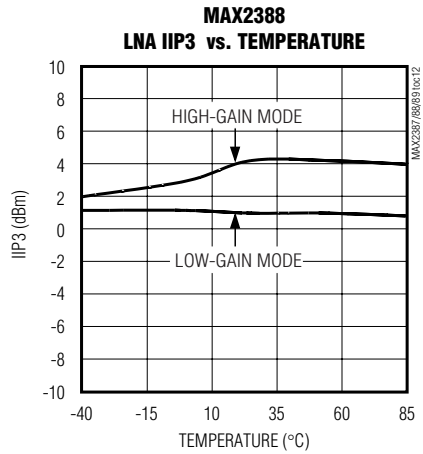
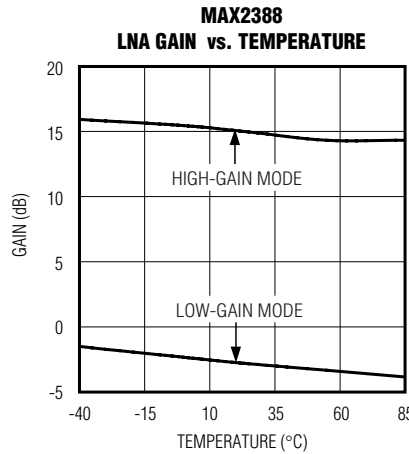
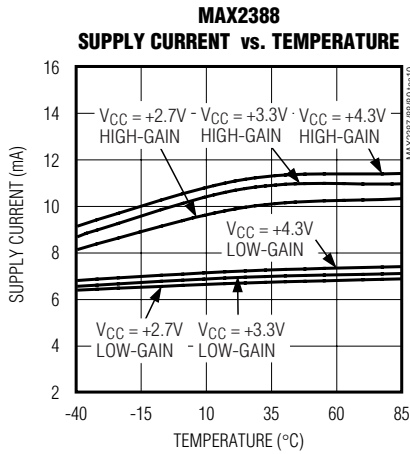

W-CDMA LNA/Mixer ICs

Typical Operating Characteristics (continued)

($T_A = +25^\circ\text{C}$, $V_{CC} = +2.7\text{V}$, unless otherwise noted.)

MAX2387/MAX2388/MAX2389

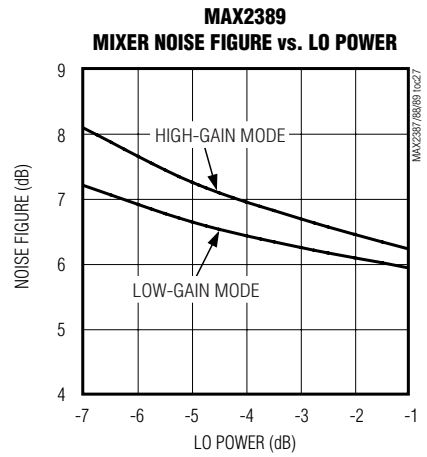
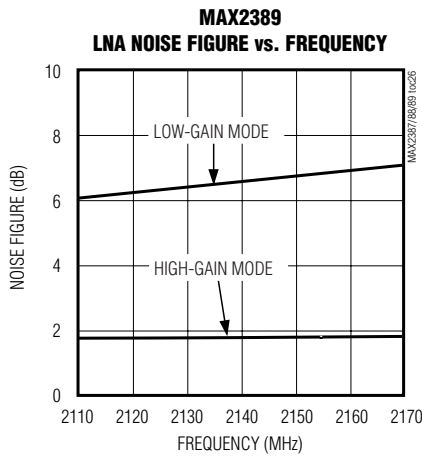
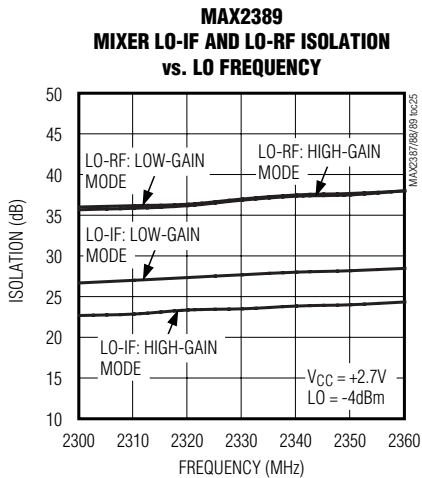
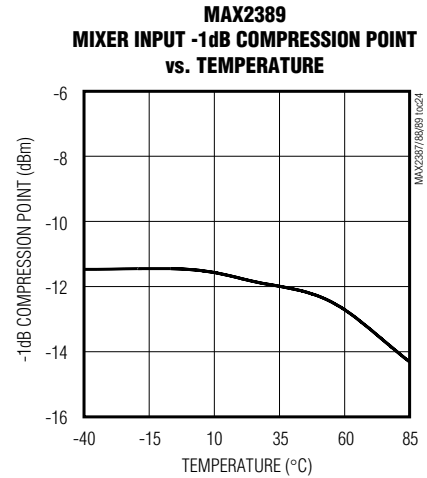
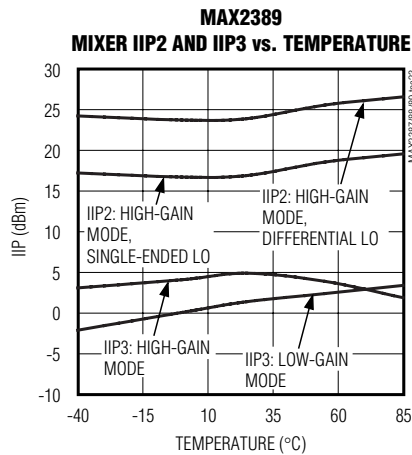
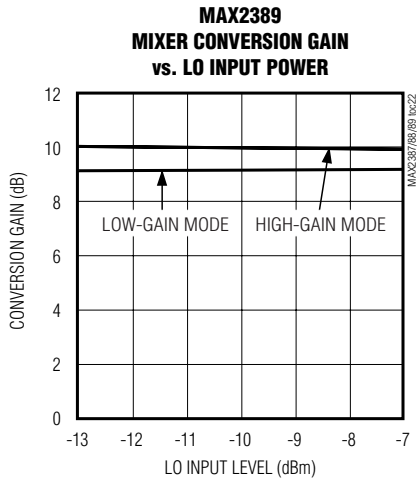
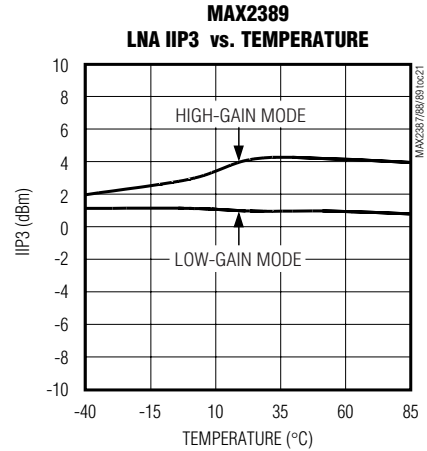
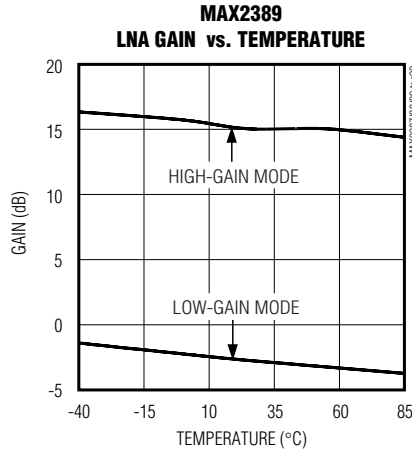
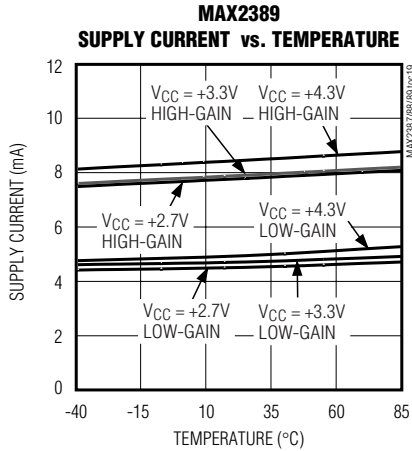

W-CDMA LNA/Mixer ICs

Pin Description

PIN	NAME	FUNCTION
1	LNA_OUT	RF Output Port for LNA. Requires external matching.
2	GAIN	LNA/Mixer Gain Control Input
3	MIX_IN	RF Input Port for Mixer. Internally matched to 50Ω.
4	SHDN	Shutdown Input. Drive low to enable shutdown mode. Drive high or connect to V _{CC} for normal operation.
5	LO+	Noninverting LO Input for LO Buffer (MAX2387/MAX2388) or Mixer (MAX2389). Differential input impedance is 200Ω. AC-couple to GND when the LO is driven single-endedly.
6	LO-	Inverting LO Input for LO Buffer (MAX2387/MAX2388) or Mixer (MAX2389). Differential input impedance is 200Ω.
7	IF-	Inverting Mixer's IF Open-Collector Output
8	IF+	Noninverting Mixer's IF Open-Collector Output
9	V _{CC}	Supply Voltage (+2.7V to +3.3V). Capacitively bypass to GND near the IC.
10	LNA_IN	RF Input Port for LNA. Requires external matching.
11	GND	Ground
12	BIAS	LNA/Mixer Bias Pin. For nominal bias, connect 24kΩ ±1% resistor to GND.

Detailed Description

The MAX2387/MAX2388/MAX2389 include an LNA and downconverter mixer. These devices feature a shutdown mode to power down the IC during the front-end receiver's idle periods. Each IC operates from a +2.7V to +3.3V single supply and is housed in a 12-pin ultra-small QFN (3mm × 3mm) leadless package.

The MAX2387/MAX2388/MAX2389 are fabricated using an advanced high-frequency silicon germanium process. The LNA and mixer NF and IIP3 have been optimized to provide excellent RF performance in the 2110MHz to 2170MHz band, while drawing minimal current.

For the MAX2387/MAX2388, the mixer's performance is optimized for a -10dBm typical drive at the LO buffer input port. The MAX2389's mixer performance is optimized for a -4dBm typical drive at the LO input port. The LO port for all versions can be driven either single-ended or differentially.

LNA High/Low-Gain Mode

These devices offer two modes of operation for the LNA: high-gain mode and low-gain mode, selectable with a GAIN select pin. The MAX2387 has a gain of 15dB in high-gain mode and -16.6dB in low-gain mode. The MAX2388/MAX2389 have a gain of 15dB in high-gain mode and -2.8dB in low-gain mode. Matching LNA in high-gain mode will ensure matching in low-gain mode.

Downconverter Mixer

The receive mixer is a wideband, single-balanced design with exceptional noise figure and linearity. The LO input frequency range is 2330MHz to 2360MHz and the RF input frequency range is 2110MHz to 2170MHz. The mixer is internally matched to 50Ω, thus eliminating any external matching components.

LO Input Buffers

The MAX2387/MAX2388 feature open-collector LO buffers to increase isolation between the LO and the rest of the system. The MAX2389 offers a lower current consumption for applications that do not require an LO buffer.

RF Inputs

The MIX_IN input is typically connected to the LNA output through an off-chip filter providing image rejection and out-of-band interferers filtering. The LNA input and output require an external matching network to 50Ω. Note that the mixer input is internally matched to 50Ω. See Figure 1, *Typical Application Circuits* for 2.14GHz.

LO Inputs

The LO+ and LO- pins are internally terminated with 100Ω resistors. AC-couple the local-oscillator signal to these pins. If a single-ended LO source is used, connect LO+ to ground using an AC-coupling capacitor.

W-CDMA LNA/Mixer ICs

IF Output Port

The mixer output appears on the differential IF+ and IF- pins. These open-collector outputs require an external inductor to V_{CC} for DC biasing. This port typically requires a matching network for coupling to an external IF filter. Figures 1 and 2 show examples of differential and single-ended IF port connections.

Applications Information

Layout

A properly designed PC board is essential to any RF/microwave circuit. Keep RF signal lines as short as possible to minimize losses and radiation. Always use controlled impedance lines on all high-frequency inputs and outputs and use low-inductance connections to ground on all GND pins. At the mixer outputs, keep the differential lines together and of the same length to ensure signal balance.

For the best gain and noise performance, use high-quality components for the LNA input matching circuit, and solder the slug evenly to the board ground plane.

For the power supplies, a star topology works well to isolate between different sections of the device. Each V_{CC} node has its own path to a central V_{CC}. Place decoupling capacitors that provide low impedance at the RF frequency of interest close to all V_{CC} connections. The central V_{CC} should have a large decoupling capacitor as well. (Use MAX2387/MAX2388/MAX2389 EV kit as an example.)

Chip Information

TRANSISTOR COUNT: 208

Typical Application Circuits

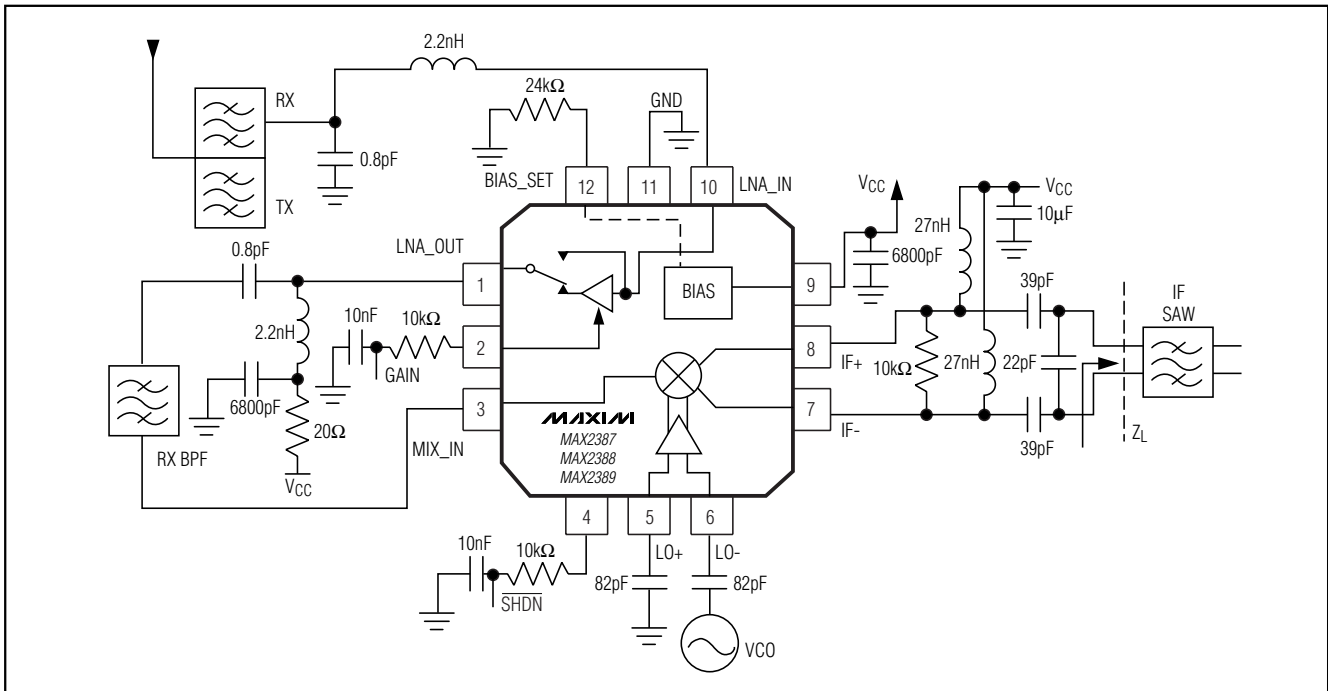

Figure 1. MAX2387/MAX2388/MAX2389 Differential IF Load; Single-Ended VCO

W-CDMA LNA/Mixer ICs

MAX2387/MAX2388/MAX2389

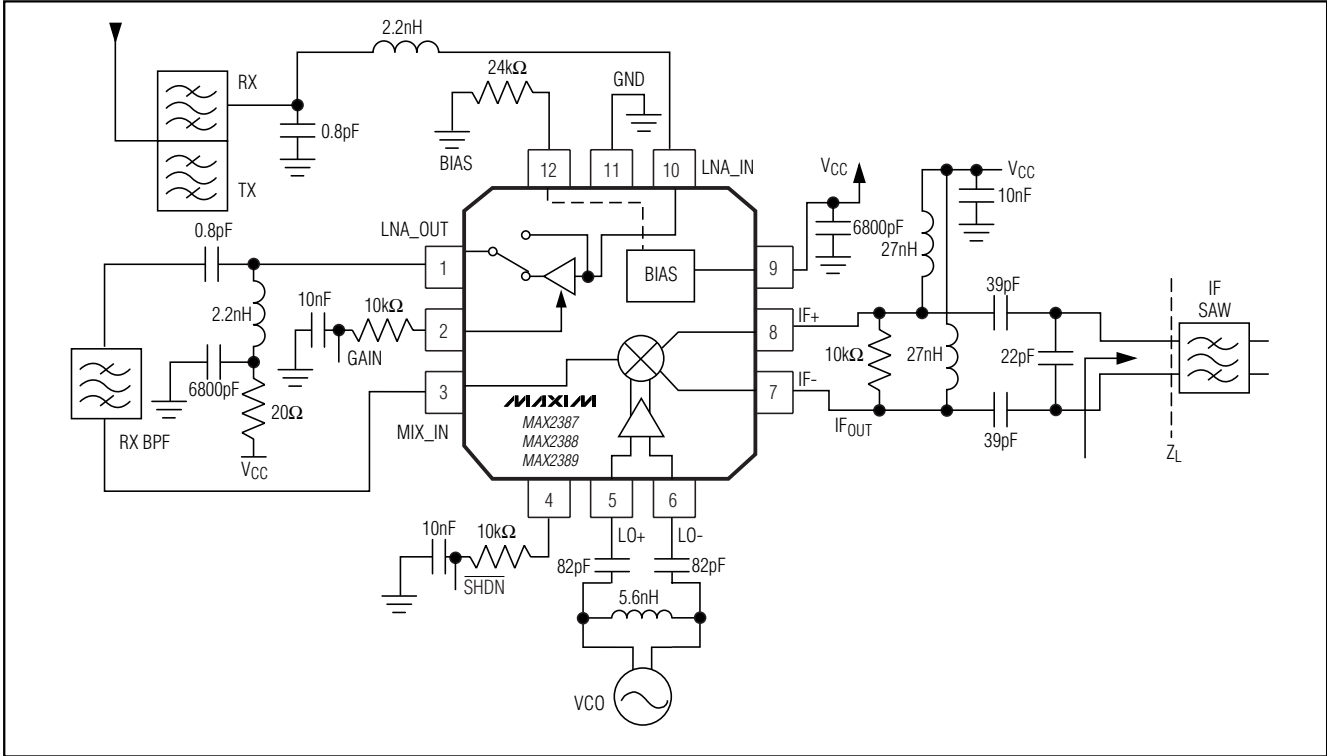

Figure 2. MAX2387/MAX2388/MAX2389 Differential IF Load; Differential VCO

W-CDMA LNA/Mixer ICs

MAX2387/MAX2388/MAX2389

Table 1. LNA Input/Output S-Parameters (VCC = +2.7V, High-Gain Mode)

S-PARAMETERS	LNA (S11)		LNA (S21)		LNA (S12)		LNA (S22)	
	FREQUENCY (MHZ)	MAGNITUDE	PHASE	MAGNITUDE	PHASE	MAGNITUDE	PHASE	MAGNITUDE
600	0.83287	-41.655	5.2176	146.82	0.020023	79.051	0.92461	-15.535
700	0.81889	-43.792	5.0791	145.33	0.021153	78.88	0.9171	-16.23
800	0.80364	-46.486	4.9464	143.26	0.022406	78.412	0.91098	-17.187
900	0.78522	-49.489	4.7767	141.09	0.023962	79.181	0.90108	-18.177
1000	0.76638	-53.118	4.6109	138.2	0.025913	78.989	0.8914	-19.536
1100	0.74542	-56.424	4.4363	135.68	0.027189	79.621	0.87913	-20.759
1200	0.72614	-59.477	4.2861	133.2	0.028484	79.666	0.86957	-22.045
1300	0.70338	-62.232	4.1209	130.93	0.030015	80.686	0.85623	-23.156
1400	0.68291	-64.933	4.0146	128.4	0.030979	81.41	0.84504	-24.46
1500	0.66114	-67.298	3.8951	126.82	0.032236	82.856	0.83313	-25.525
1600	0.63958	-69.782	3.7818	124.53	0.033056	83.763	0.82095	-26.882
1700	0.61641	-72.041	3.6761	122.88	0.03398	85.56	0.80875	-28.147
1800	0.59303	-74.571	3.5823	120.51	0.035009	86.377	0.79497	-29.825
1900	0.56989	-76.974	3.5198	118.87	0.036332	88.572	0.78338	-31.503
2000	0.54509	-79.651	3.4376	116.77	0.036887	89.686	0.76891	-33.44
2100	0.52084	-82.452	3.3691	115.17	0.038318	91.409	0.75735	-35.559
2200	0.49554	-85.891	3.2858	112.47	0.039355	93.409	0.74365	-38.175
2300	0.47232	-89.473	3.2544	110.28	0.040817	94.973	0.73415	-41.034
2400	0.44892	-93.529	3.195	108.05	0.042049	97.086	0.72262	-44.165
2500	0.42766	-98.164	3.1347	105.62	0.043438	98.58	0.71335	-47.828
2600	0.40833	-103.42	3.06	102.94	0.044844	100.14	0.70474	-51.733
2700	0.39421	-109.16	2.9818	100.13	0.046899	101.7	0.70067	-56.04
2800	0.38321	-115.32	2.9149	96.964	0.048389	103.31	0.69795	-60.397
2900	0.37608	-121.52	2.821	94.462	0.049426	104.62	0.69514	-64.899
3000	0.37573	-128.03	2.7086	91.479	0.05079	106.39	0.69504	-69.425
3100	0.38123	-134.23	2.5802	88.528	0.051657	108.22	0.69915	-73.798
3200	0.39208	-139.73	2.4696	85.584	0.053915	110.43	0.70504	-77.625
3300	0.40626	-144.57	2.3296	83.264	0.055483	113.29	0.71095	-81.166
3400	0.42512	-148.8	2.2157	80.95	0.05783	115.29	0.71819	-84.4
3500	0.44708	-152.13	2.0519	79.588	0.060614	118.09	0.72516	-87.06
3600	0.47302	-154.7	1.9382	77.337	0.065129	119.23	0.73416	-89.168
3700	0.49849	-156.57	1.8048	76.594	0.069104	120.99	0.73997	-90.676

Package Information

For the latest package outline information, go to www.maxim-ic.com/packages.

Maxim cannot assume responsibility for use of any circuitry other than circuitry entirely embodied in a Maxim product. No circuit patent licenses are implied. Maxim reserves the right to change the circuitry and specifications without notice at any time.

Maxim Integrated Products, 120 San Gabriel Drive, Sunnyvale, CA 94086 408-737-7600 _____ 11

SITE
SEARCHPART NO.
SEARCH

WHAT'S NEW

PRODUCTS

SOLUTIONS

DESIGN

APPNOTES

SUPPORT

BUY

COMPANY

MEMBERS

MAX2388

Part Number Table

Notes:

1. See the [MAX2388 QuickView Data Sheet](#) for further information on this product family or download the [MAX2388 full data sheet](#) (PDF, 192kB).
2. Other options and links for purchasing parts are listed at: <http://www.maxim-ic.com/sales>.
3. [Didn't Find What You Need?](#) Ask our applications engineers. Expert assistance in finding parts, usually within one business day.
4. Part number suffixes: T or T&R = tape and reel; + = RoHS/lead-free; # = RoHS/lead-exempt. More: See [full data sheet](#) or [Part Naming Conventions](#).
5. * Some packages have variations, listed on the drawing. "PkgCode/Variation" tells which variation the product uses.

Part Number	Free Sample	Buy Direct	Package: TYPE PINS SIZE DRAWING CODE/VAR *	Temp	RoHS/Lead-Free? Materials Analysis
MAX2388EVKIT					RoHS/Lead-Free: No
MAX2388EGC			QFN;12 pin;3x3x0.9mm Dwg: 21-0102G (PDF) Use pkgcode/variation: G1233-1*	-40C to +85C	RoHS/Lead-Free: No Materials Analysis
MAX2388EGC-T			QFN;12 pin;3x3x0.9mm Dwg: 21-0102G (PDF) Use pkgcode/variation: G1233-1*	-40C to +85C	RoHS/Lead-Free: No Materials Analysis
MAX2388EGC+			QFN;12 pin;3x3x0.9mm Dwg: 21-0102G (PDF) Use pkgcode/variation: G1233+1*	-40C to +85C	RoHS/Lead-Free: Yes Materials Analysis
MAX2388EGC+T			QFN;12 pin;3x3x0.9mm Dwg: 21-0102G (PDF) Use pkgcode/variation: G1233+1*	-40C to +85C	RoHS/Lead-Free: Yes Materials Analysis
MAX2388ETC+			THIN QFN;12 pin;3X3X0.8mm Dwg: 21-0136I (PDF) Use pkgcode/variation: T1233+3*	-40C to +85C	RoHS/Lead-Free: Yes Materials Analysis
MAX2388ETC+T			THIN QFN;12 pin;3X3X0.8mm Dwg: 21-0136I (PDF) Use pkgcode/variation: T1233+3*	-40C to +85C	RoHS/Lead-Free: Yes Materials Analysis

[Didn't Find What You Need?](#)

[CONTACT US: SEND US AN EMAIL](#)

Copyright 2007 by Maxim Integrated Products, Dallas Semiconductor • [Legal Notices](#) • [Privacy Policy](#)