

## N-Channel Enhancement Mode MOSFET

### 1. Product Information

#### 1.1 Features

**Surface-mounted package**  
**Super Trench**  
**T<sub>j</sub> max 175°**  
**Advanced trench cell design**  
**MSL1**

#### 1.2 Applications

**Power Tool appliances**  
**BMS appliances**  
**High power inverter system**

#### 1.3 Quick reference

**$BV \geq 150\text{ V}$**   
 **$P_{tot} \leq 375\text{ W}$**   
 **$I_D \leq 220\text{ A}$**   
 **$R_{DS(ON)} \leq 5.0\text{ m}\Omega @ V_{GS} = 10\text{ V}$**   
 **$R_{DS(ON)} \leq 6.0\text{ m}\Omega @ V_{GS} = 6\text{ V}$**

### 2. Pin Description

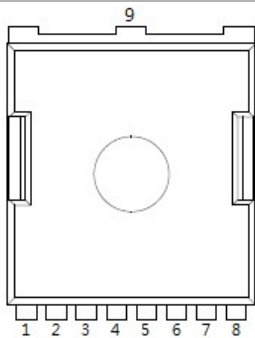
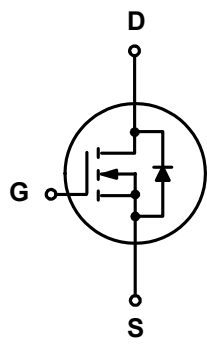
Pin	Description	Simplified Outline	Symbol
1	Gate(G)	 <p style="text-align: center;">Top View TOLL</p>	
2,3,4,5,6,7,8	Source(S)		
9	Drain(D)		

### 3. Limiting Values

Symbol	Parameter	Conditions	Min	Max	Unit
V <sub>DS</sub>	Drain-Source Voltage	T <sub>C</sub> = 25 °C	150	-	V
V <sub>GS</sub>	Gate-Source Voltage	T <sub>C</sub> = 25 °C	-	±25	V
I <sub>D</sub> *	Drain Current ( DC )	T <sub>C</sub> = 25 °C, V <sub>GS</sub> = 10 V	-	220	A
		T <sub>C</sub> = 100 °C, V <sub>GS</sub> = 10 V	-	120	A
I <sub>DM</sub> *	Drain Current ( Pulsed )	T <sub>C</sub> = 25 °C, V <sub>GS</sub> = 10 V	-	680	A
P <sub>tot</sub>	Drain power dissipation	T <sub>C</sub> = 25 °C	-	375	W
T <sub>stg</sub>	Storage Temperature		-55	175	°C
T <sub>J</sub>	Junction Temperature		-	175	°C
I <sub>S</sub>	Continuous-Source Current	T <sub>C</sub> = 25 °C	-	220	A
I <sub>AS</sub>	Single Pulsed Avalanche Current	V <sub>DD</sub> =100V , L=0.05mH	-	160	A
E <sub>AS</sub>	Single Pulsed Avalanche Energy	V <sub>DD</sub> =100V , L=1.0mH	-	1250	mJ
R <sub>θJA</sub> **	Thermal Resistance- Junction to Ambient		-	32.8	°C/W
R <sub>θJC</sub> **	Thermal Resistance- Junction to Case		-	0.4	

Notes :

\* Pulse width ≤ 300 μs, duty cycle ≤ 2 %

\*\* Surface Mounted on minimum footprint pad area.

\*\*\* Limited by bonding wire

### 4. Ordering Code

Product Name	Package	Reel Size	Tape width	Quantity	Note
<b>IPT054N15N5</b>	<b>TOLL-8L</b>			<b>2000</b>	

Note: NHCX defines " Green " as lead-free ( RoHS compliant ) and halogen free ( Br or Cl does not exceed 900 ppm by weight in homogeneous material and total of Br and Cl does not exceed 1500 ppm by weight; Follow IEC 61249-2-21 and IPC / JEDEC J-STD-020C )

**5. Electrical Characteristics** (  $T_A=25^\circ$  Unless Otherwise Noted )

Symbol	Parameter	Conditions	Min	Typ	Max	Unit
<b>Static Characteristics</b>						
$BV_{DSS}$	Drain-Source Breakdown Voltage	$V_{GS} = 0\text{ V}, I_{DS} = 250\ \mu\text{A}$	150	-	-	V
$V_{GS(th)}$	Gate Threshold Voltage	$V_{DS} = V_{GS}, I_{DS} = 250\ \mu\text{A}$	2	-	4	V
$I_{DSS}$	Drain Leakage Current	$V_{DS} = 120\text{ V}, V_{GS} = 0\text{ V}$	-	-	1	$\mu\text{A}$
$I_{GSS}$	Gate Leakage Current	$V_{GS} = 0\text{ V}, V_{GS} = \pm 25\text{ V}$	-	-	$\pm 100$	nA
$R_{DS(on)}^a$	On-State Resistance	$V_{GS} = 10\text{ V}, I_{DS} = 50\text{ A}$	-	4.5	5.0	m $\Omega$
		$V_{GS} = 6\text{ V}, I_{DS} = 25\text{ A}$	-	5.0	6.0	
<b>Diode Characteristics</b>						
$V_{SD}^a$	Diode Forward Voltage	$I_{SD} = 50\text{ A}, V_{GS} = 0\text{ V}$	-	-	1.3	V
$t_{rr}$	Reverse Recovery Time	$I_{DS} = 50\text{ A}, V_{GS} = 0\text{ V}$ $di_{SD}/dt = 100\text{ A}/\mu\text{s}$	-	115	-	nS
$Q_{rr}$	Reverse Recovery Charge		-	480	-	nC
<b>Dynamic Characteristics<sup>b</sup></b>						
$C_{iss}$	Input Capacitance	$V_{GS} = 0\text{ V}, V_{DS} = 75\text{ V}$ Frequency = 1 MHz	-	9320	-	pF
$C_{oss}$	Output Capacitance		-	570	-	
$C_{riss}$	Reverse Transfer Capacitance		-	60	-	
$t_{d(on)}$	Turn-on Delay Time	$V_{DS} = 75\text{ V}, V_{GEN} = 10\text{ V},$ $R_G = 3.9\ \Omega, R_L = 1.5\ \Omega,$ $I_{DS} = 50\text{ A}$	-	24	-	nS
$t_r$	Turn-on Rise Time		-	70	-	
$t_{d(off)}$	Turn-off Delay Time		-	112	-	
$t_f$	Turn-off Fall Time		-	75	-	
<b>Gate Charge Characteristics<sup>b</sup></b>						
$Q_g$	Total Gate Charge	$V_{DS} = 75\text{ V}, V_{GS} = 10\text{ V},$ $I_{DS} = 50\text{ A}$	-	158	-	nC
$Q_{gs}$	Gate-Source Charge		-	48	-	
$Q_{gd}$	Gate-Drain Charge		-	39	-	

Notes :

 a : Pulse test ; pulse width  $\leq 300\ \mu\text{s}$ , duty cycle  $\leq 2\%$ 

b : Guaranteed by design, not subject to production testing

## 6. Typical Characteristics

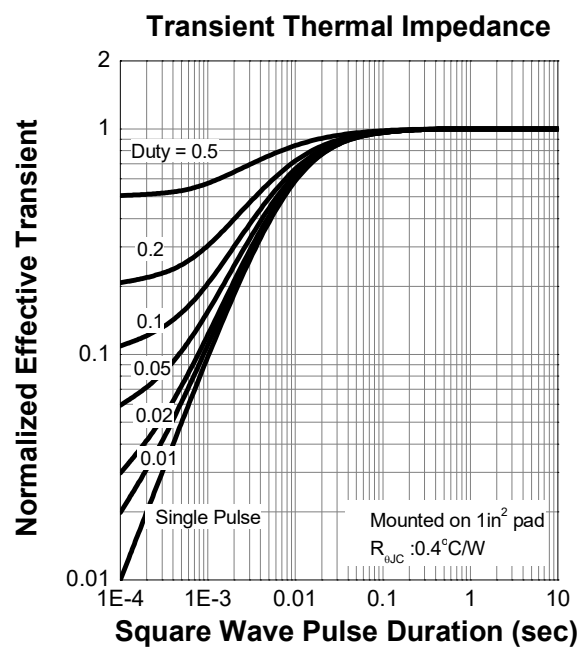
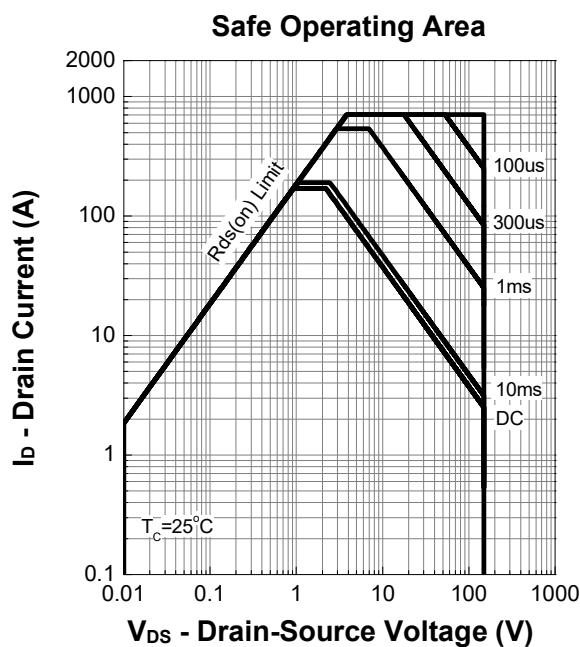
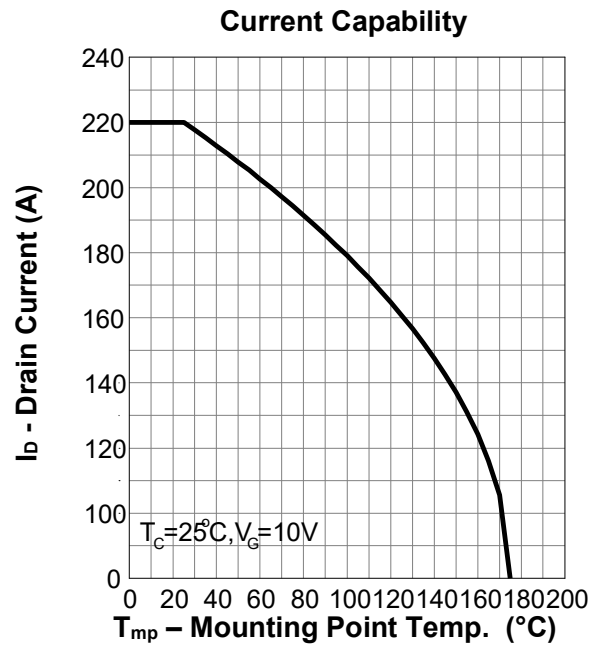
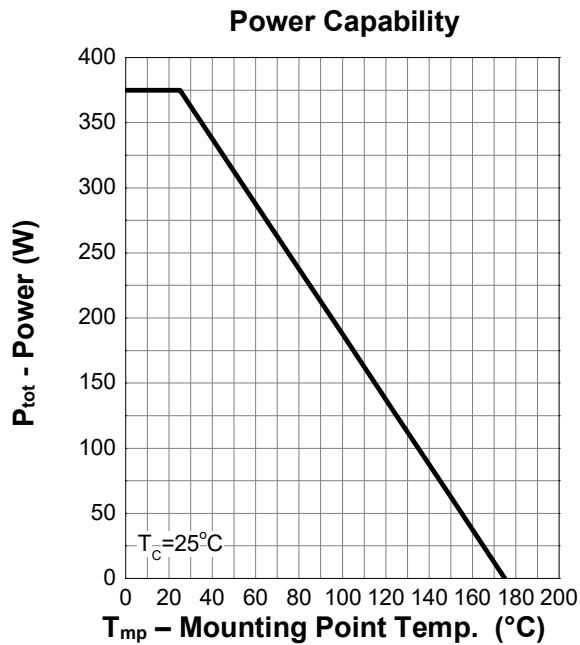

## 6. Typical Characteristics (cont.)

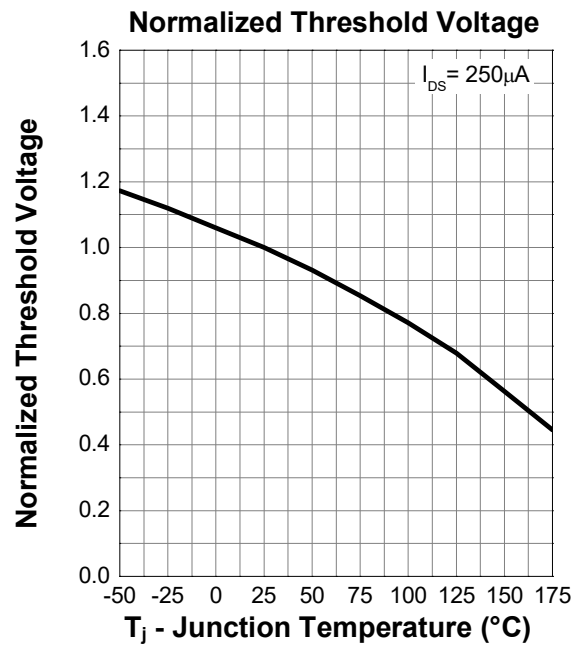
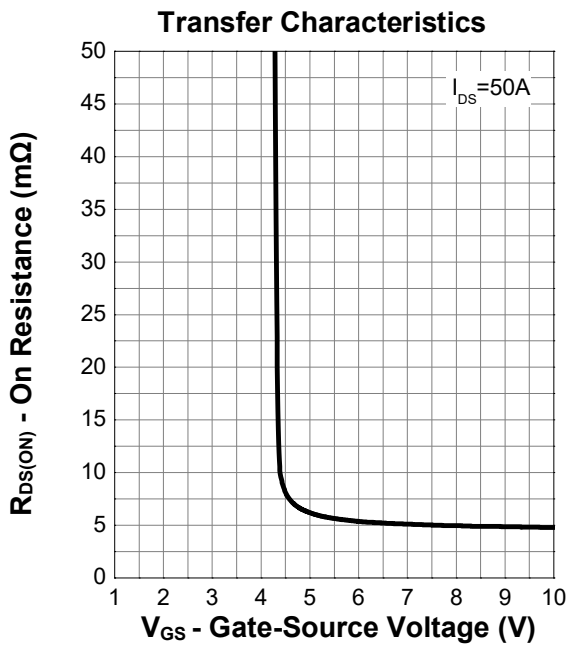
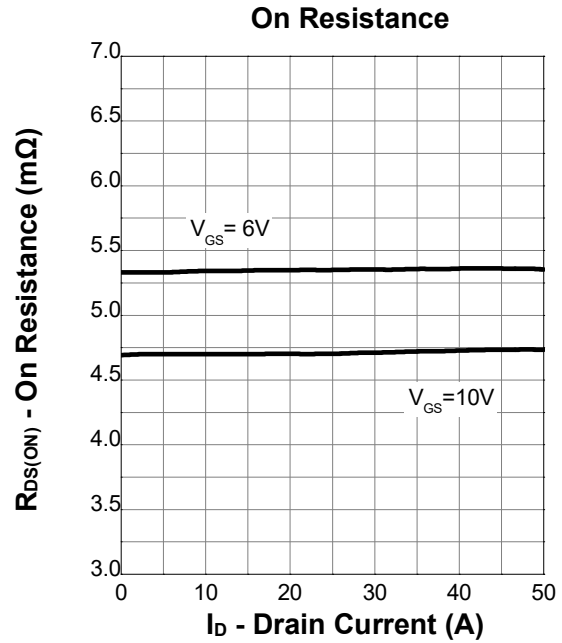
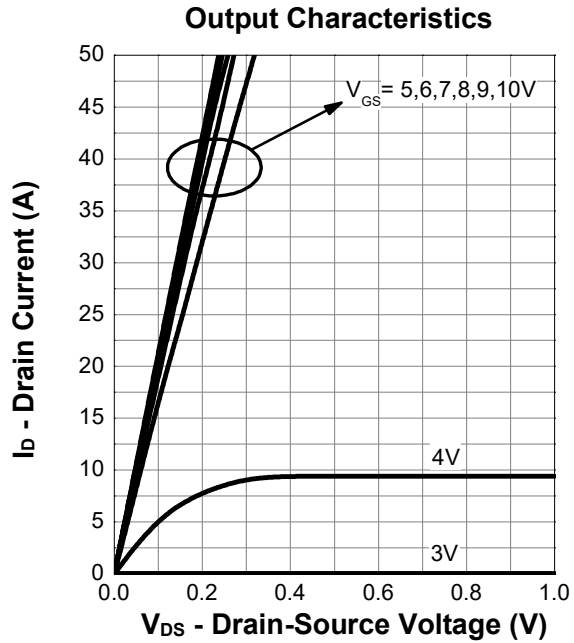

## 6. Typical Characteristics (cont.)

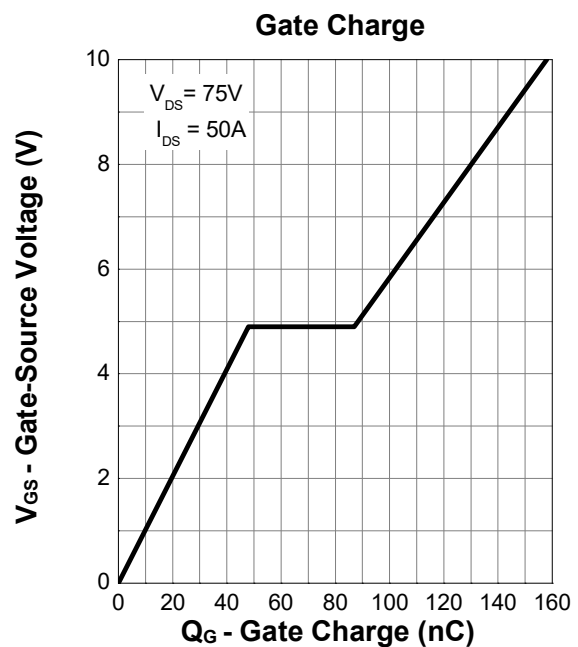
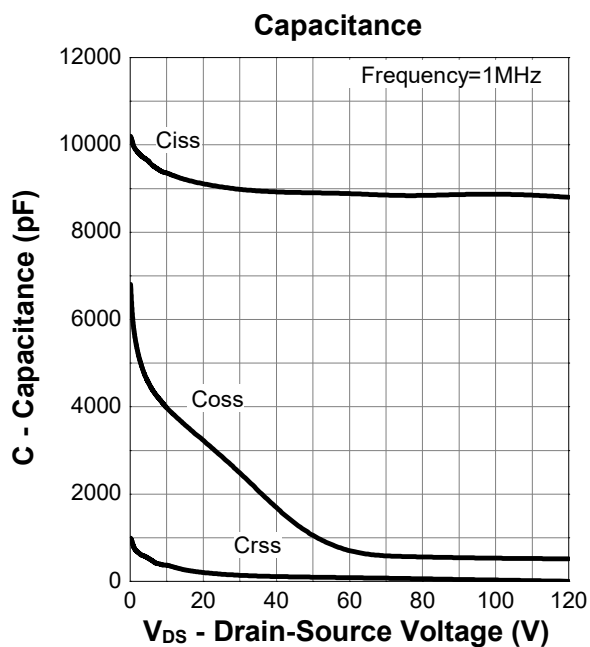
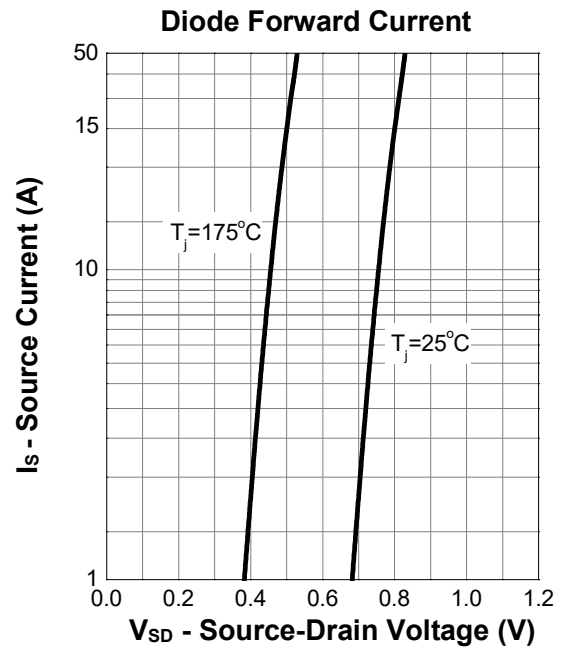
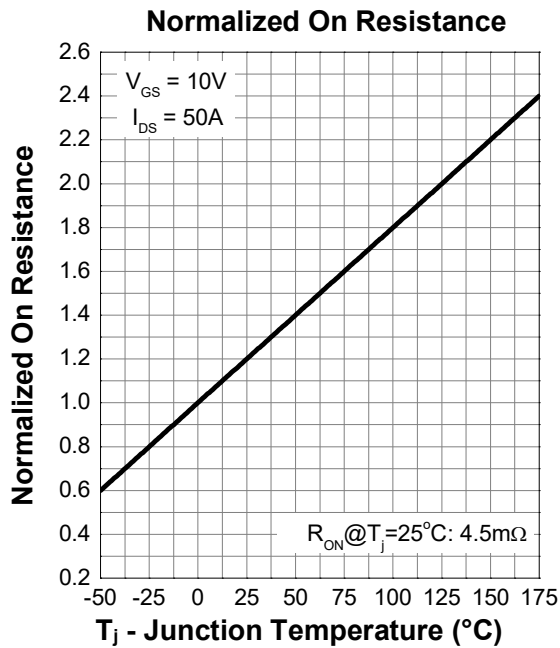

## 7. Package Dimensions

TOLL-8L Package

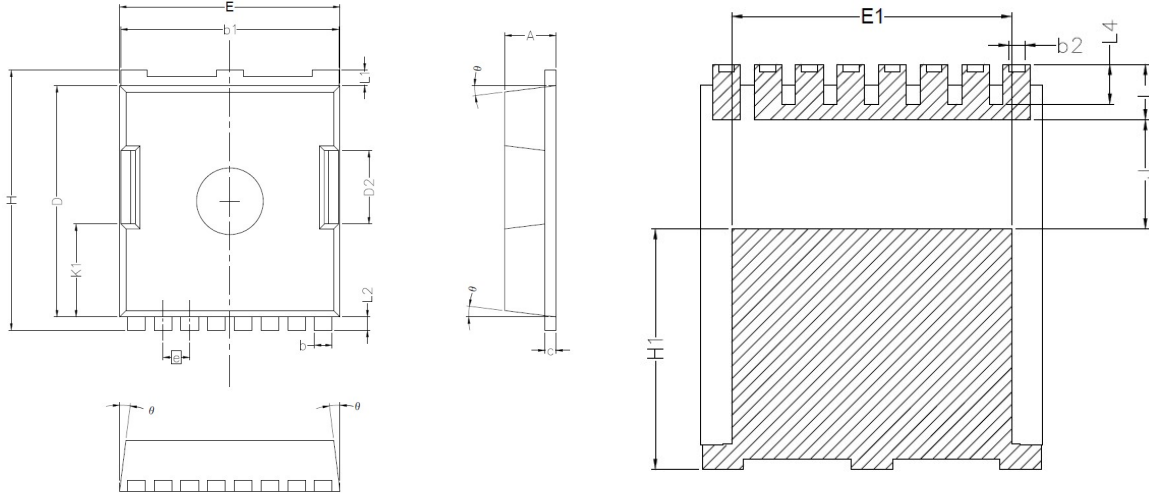

Symbol	Dimensions In Millimeters	
	MIN.	MAX.
A	2.20	2.40
b	0.70	0.90
b1	9.70	9.90
b2	0.42	0.50
c	0.40	0.60
D	10.28	10.58
D2	3.10	3.50
E	9.70	10.10
E1	7.90	8.30
e	1.20BSC	
H	11.48	11.88
H1	6.75	7.15
N	8	
J	3.00	3.30
K1	3.98	4.38
L	1.40	1.80
L1	0.60	0.80
L2	0.50	0.70
L4	1.00	1.30
$\theta$	4°	10°