

PSRP Series-Prosemi Shunt Resistors

PSRP Series

Features

- Metal Alloy Low-Resistance shunt resistor.
- Resistance value 0.1mΩ, 0.2mΩ, 0.3mΩ, 0.5mΩ, 1mΩ, 1.5mΩ, 2mΩ, 3mΩ, 4mΩ.
- Low thermal EMF.
- Low TCR.
- Very low inductance.
- Halogen free, lead free and RoHS compliant.
- AEC-Q200 qualified available.

Applications

- Power modules.
- Frequency converters.
- Current sensor for power hybrid sources high current for automotive.
- Lithium battery protection board.

Part Number

PSRP 25 M 6 F 0M50

【1】 【2】 【3】 【4】 【5】 【6】

【1】 Series Name: Prosemi Shunt Resistor for High Power Applications.

【2】 Chip Size: 25: 2512, 39: 3921, 59: 5930

【3】 Material: M: CuMn, K: NiCr, F: FeCr, S:CuMnSn.

【4】 Power Rating: 15=15W, 10=10W, 6=6W, 4=4W.

【5】 Resistance Precision: D: ±0.5%, F: ±1%, G: ±2%, J: ±5%.

【6】 Resistance Code: R002: 2mΩ, 0M50: 0.5mΩ, 1M50: 1.5mΩ.

Electrical Characteristics

Size	Power Rating at 70°C* (W)	Resistance Range(mΩ)** ±0.5%; ±1%; ±2%; ±5%	Element Material	Operation Temperature Range	Temperature coefficient (ppm/°C)
2512	6	0.3	M	-55°C~+170°C	±175
	6	0.5	M		±115
	6	1	M		±100
	6	2	K		±75
	4	3	K		±75
	4	4	K		±75

PSRP Series-Prosemi Shunt Resistors

PSRP Series

3921	10	0.3	M	-55°C~+170°C	±150
	9	0.5	M		±75
	9	1	M		±75
			F		±30
	7	2	K		±60
	5	3	K		±60
			F		±30
5	4	K	±50		
5930	15	0.1	S		±200
	15	0.2	M		±100
	10	0.3	M		±100
	10	0.5	M		±75
	9	1	K		±50
			F		±30
	8	1.5	K	±50	
7	2	K	±50		

“**”: Power at terminal temperature of 70°C.

“** **”: Development schedule will vary depending on resistance value. Please contact us for resistance values.

Physical Dimensions

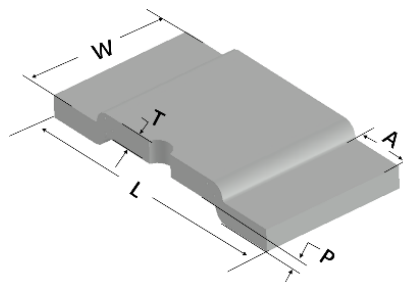

Unit: mm

Size	Resistance (mΩ)	L	W	T	A	P	Element Material
2512	0.3	6.4±0.2	3.2±0.2	0.95±0.1	1.53±0.3	0.4±0.1	M
	0.5			0.7±0.1			M
	1			0.35±0.1			M
	2			0.5±0.1			K
	3			0.3±0.1			K
	4			0.25±0.1			K
3921	0.3	10±0.2	5.2±0.2	1.42±0.1	1.9±0.3	0.5±0.1	M
	0.5			0.8±0.1			M
	1			0.4±0.1			M
				1.35±0.1			F
	2			0.6±0.1			K
	3			0.4±0.1			K/F
4	0.3±0.1	K					

PSRP Series-Prosemi Shunt Resistors

PSRP Series

5930	0.1	15±0.3	7.6±0.4	2.0±0.1	4.2±0.3	0.5±0.1	S
	0.2			1.5±0.1			M
	0.3			1.0±0.1			M
	0.5			0.6±0.1			M
	1			0.91±0.1			K/F
	1.5			0.60±0.1			K
	2			0.45±0.1			K

Recommended Solder Pad Layout

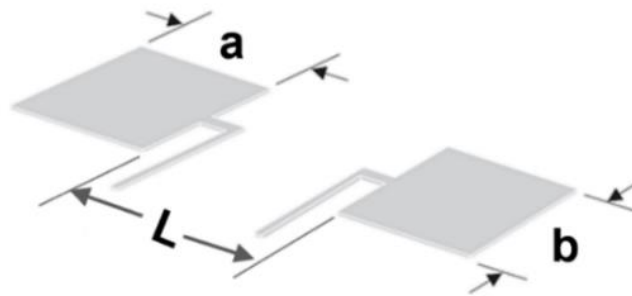

Unit: mm

Type	L	a	b
2512	3.0	2.3	3.5
3921	5.6	2.7	6.2
5930	5.6	5.2	8.75

Construction

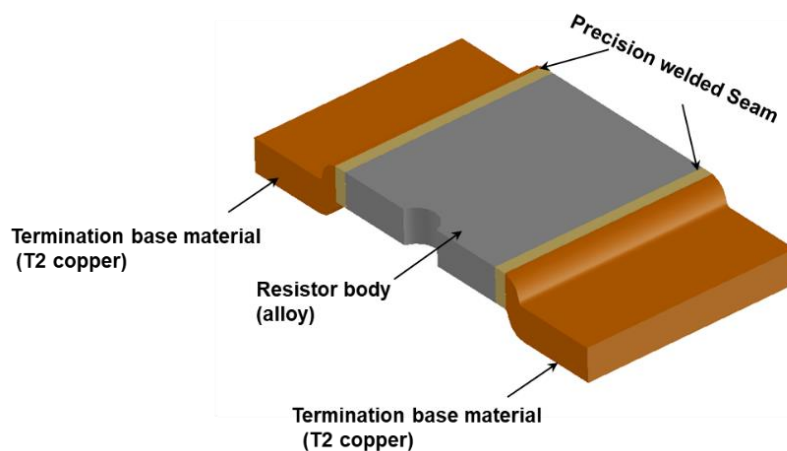

Power Derating Curve

For resistors operated in ambient temperatures 70°C, power rating shall be derated in according with the curve below:

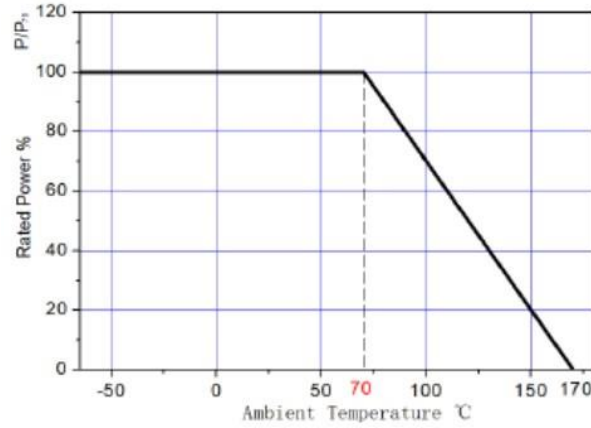

Recommended Solder Curve

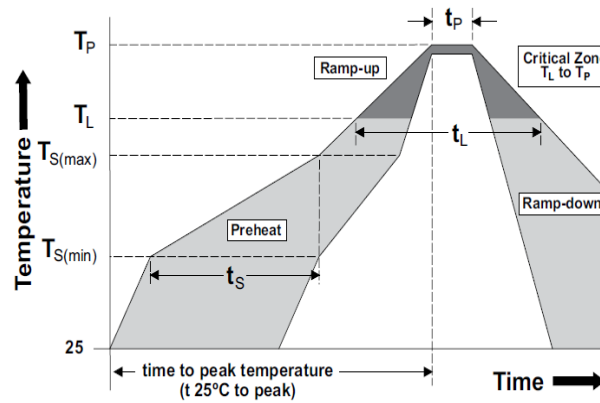

Reflow Condition		Pb – Free assembly
Pre heat	- Temperature Min (Ts(min))	150°C
	- Temperature Max (Ts(max))	200°C
	- Time (Min to Max) (ts)	60 – 120 secs
Average ramp up rate (Liquidus Temp (T _L) to peak)		5°C/second max
Ts(max) to T _L - Ramp-up Rate		5°C/second max
Reflow	- Temperature (T _L) (Liquidus)	217°C
	- Time (t _L)	60 – 150 seconds
Peak Temperature (T _P)		260°C
Time within 5°C of actual peak Temperature (t _p)		20 – 40 seconds
Ramp-down Rate		5°C/second max
Time 25°C to peak Temperature (T _P)		8 minutes Max.
Wave Soldering		Not applicable
Hand Soldering		350°C, 5 seconds max.

Marking Instructions

PSRP is marked with three or four digit, We have two different ways of marking:

- a. "R" designates the decimal location in ohms,
e. g. For PSRP39, PSRP59: 1mΩ: R001; For PSRP25: 1mΩ: 001
- b. "m" designates the decimal location in milliohms,
e. g. For PSRP39, PSRP59: 0.5mΩ: 0m50, 1.5mΩ: 1m50; For PSRP25: 0.5mΩ: 0m5

Product Characteristics

Item	Test condition/ Methods	Limited	Standard
Resistance	Measuring resistance value at room temperature 25°C±5°C	Refer to Spec	IEC60115-1 4.5
Temperature Coefficient of Resistance	TCR (ppm/°C) = (R2-R1/R1*(T2-T1))X 10 ⁶ R1: resistance value measured at room temperature (Ω) R2: Resistance measured at 125 ° C (Ω) T1: room temperature (° C) T2: 125 °C	Refer to Spec	IEC 60115-1 4.8
Short Time Overload	Apply 5 times rated power for 5 seconds, and measure the resistance change after standing for 24 hours.	≤±0.5%	IEC 60115-1 4.13
High Temperature Storage	170°C for 1000 hours, No power.	≤±1%	MIL-STD-202 Method 108
Temperature Cycling	Pre-treatments with 3X reflow , -55 °C (15min)/+150 °C (15min), 1000 cycles, transition time less than 1 minute	≤±0.5%	JESD22-A104
Bias Humidity	Pre-treatments with 3X reflow, +85°C, 85% RH, 10% of operating power, 1000hours	≤±0.5%	MIL-STD-202 Method103
Operational life	Pre-treatments with 3X reflow, 70°C± 2°C, 1000 hours, at rated power 1.5 hours "ON", 0.5 hours "OFF".	≤±1%	MIL-STD-202 Method 108
Mechanical shock	Condition C ,100 g's ,6 msec, 3 mutually perpendicular axes, in 6 directions, three impacts each for a total of 18 times 18 shocks.	≤±0.5%	MIL-STD-202 Method 213
Vibration	5g's for 20 minutes 12 cycles each of 3 orientations. Test from 10 Hz - 2000 Hz	≤±0.5%	MIL-STD-202 Method 204
Resistance to Soldering Heat	Condition K, temperature above 217°C, 60s – 150s	≤±0.5%	MIL-STD-202 Method 210
Solderability	245±5°C time: 5sec+0/-0.5sec.	≥95%	J-STD-002
	260±5°C time: 30sec+5sec	≥95%	J-STD-002

Packaging

Tape Dimensions

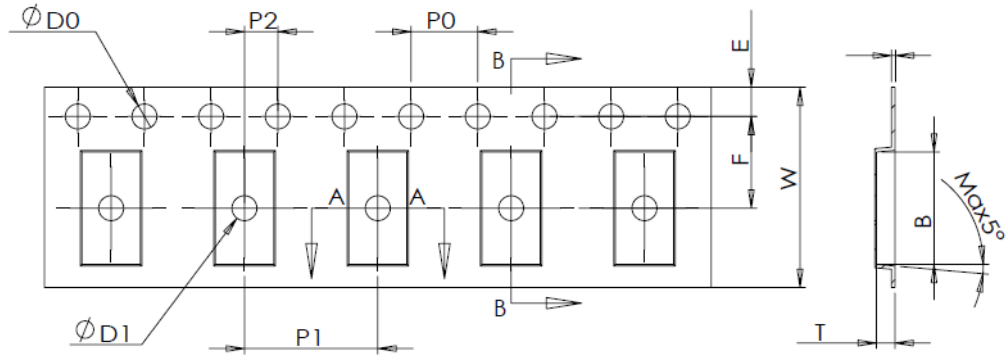

2512, 3921

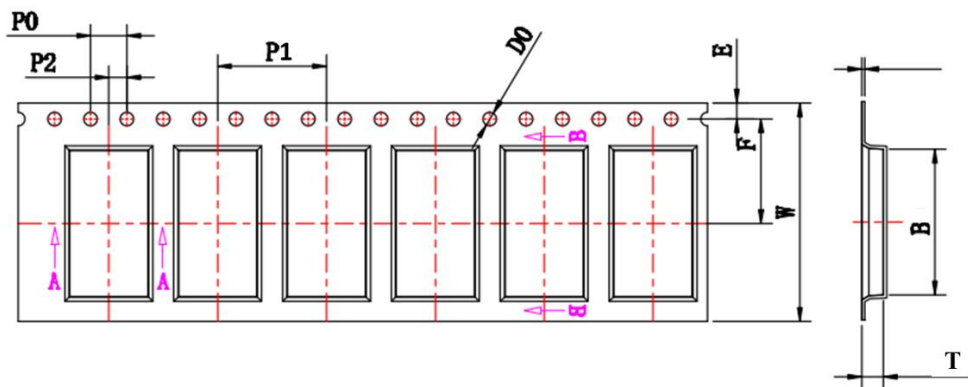

5930

Unit: mm

Series	Type	A	B	D0	E	F	φD1
2512	0.3mΩ	3.60±0.10	6.70±0.10	1.50+0.10	1.75±0.10	5.50±0.05	1.50±0.10
	0.5-4mΩ	3.50±0.10	6.74±0.10	1.50+0.10	1.75±0.10	5.50±0.05	1.50±0.10
3921	0.3mΩ, 1mΩ (FeCr)	5.70±0.10	10.50±0.10	1.50+0.10/0	1.75±0.10	7.50±0.1	/
	0.5-4mΩ	5.50±0.10	10.50±0.10	1.50+0.10/0	1.75±0.10	7.50±0.1	1.50+0.10/0
5930	0.1-2mΩ	8.60±0.10	16.00±0.10	1.50+0.10/0	1.75±0.10	11.50±0.1	/
Series	Type	W	P0	P1	P2	T	
2512	0.3mΩ	12.00±0.30	4.00±0.10	8.00±0.10	2.00±0.05	1.60±0.10	
	0.5-4mΩ	12.00±0.30	4.00±0.10	8.00±0.10	2.00±0.05	1.10±0.10	
3921	0.3mΩ, 1mΩ (FeCr)	16.00±0.30	4.00±0.10	8.00±0.10	2.00±0.10	2.250±0.10	
	0.5-4mΩ	16.00±0.30	4.00±0.10	8.00±0.10	2.00±0.10	1.50±0.10	
5930	0.1-2mΩ	24.00±0.30	4.00±0.10	12.00±0.10	2.00±0.10	2.40±0.10	

Reel Dimensions

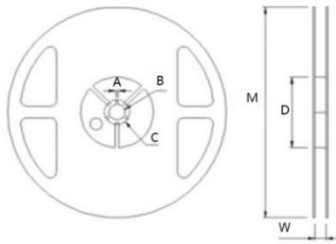

2512

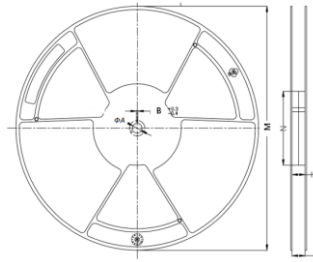

3921, 5930

Unit: mm

Series	Type	W (mm)	M (mm)	A (mm)	B (mm)	C (mm)	D (mm)
2512	7' reel	13.8±0.5	178.0±2.0	2.0±0.5	13.5±0.5	21.0±0.5	80.0±1.0
Series	Type	W (mm)	M (mm)	ΦA (mm)	N (mm)	H1 (mm)	B (mm)
3921	13' reel	16.4+3.5/-0.2	330.0±2.0	13.4±0.5	100.0±0.2	16.4±1.0	2.4±0.4
5930	13' reel	24.4+3.5/-0.2	330.0±2.0	13.4±0.5	100.0±0.2	24.4±1.0	2.4±0.4

Quantity of Package

Type	Quantity(pcs)
2512	0.3mΩ: 1000
	0.5-4mΩ: 2000
3921	0.3mΩ,1mΩ(FeCr): 2000
	0.5-4mΩ: 2500
5930	0.1-0.2mΩ: 1000
	0.3-2mΩ: 2000

Storage

- The temperature condition must be controlled at $25\pm 5^{\circ}\text{C}$, The R.H. must be controlled at $60\pm 15\%$ Store in accordance with this requirement, and the validity period is two years after the date of manufacture.
- Please avoid the mentioned harsh environment below when storing to ensure product performance and its' solderability. Places exposed to sea breeze or other corrosive gas, such as Cl_2 , H_2S , NH_3 , SO_2 and NO_2 .
- When the product is moved and stored, please ensure the correct orientation of the box. Do not drop or squeeze the box. Otherwise, the electrode or the body of the product may be damaged.