

## N-Channel Enhancement Mode MOSFET

### 1. Product Information

#### 1.1 Features

**Surface-mounted package**  
**Super Trench**  
**Advanced trench cell design**  
**MSL1**

#### 1.2 Applications

**BMS**  
**Drones**  
**High power inverter system**  
**Light electric vehicles**

#### 1.3 Quick reference

$BV \geq 85 \text{ V}$   
 $P_{tot} \leq 500 \text{ W}$   
 $I_D \leq 300 \text{ A}$   
 $R_{DS(ON)} \leq 1.4 \text{ m}\Omega @ V_{GS} = 10 \text{ V}$

### 2. Pin Description

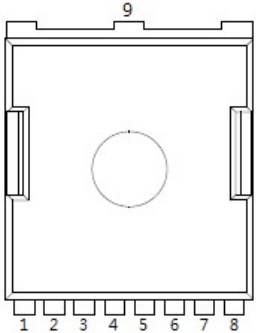
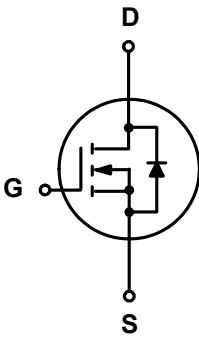
Pin	Description	Simplified Outline	Symbol
1	Gate(G)	 <p>Top View TOLL</p>	
2,3,4,5,6,7,8	Source(S)		
9	Drain(D)		

### 3. Limiting Values

Symbol	Parameter	Conditions	Min	Max	Unit
V <sub>DS</sub>	Drain-Source Voltage	T <sub>C</sub> = 25 °C	85	-	V
V <sub>GS</sub>	Gate-Source Voltage	T <sub>C</sub> = 25 °C	-	±20	V
I <sub>D</sub>	Drain Current ( DC )	T <sub>C</sub> = 25 °C, V <sub>GS</sub> = 10 V	-	300	A
		T <sub>C</sub> = 100 °C, V <sub>GS</sub> = 10 V	-	267	A
I <sub>DM</sub> *	Drain Current ( Pulsed )	T <sub>C</sub> = 25 °C, V <sub>GS</sub> = 10 V	-	1200	A
P <sub>tot</sub>	Drain power dissipation	T <sub>C</sub> = 25 °C	-	500	W
T <sub>stg</sub>	Storage Temperature		-55	150	°C
T <sub>J</sub>	Junction Temperature		-	150	°C
I <sub>S</sub>	Continuous-Source Current	T <sub>C</sub> = 25 °C	-	300	A
E <sub>AS</sub>	Single Pulsed Avalanche Energy	V <sub>DD</sub> =40V , L=0.5mH	-	2800	mJ
R <sub>θJA</sub> **	Thermal Resistance- Junction to Ambient		-	32.8	°C/W
R <sub>θJC</sub> **	Thermal Resistance- Junction to Case		-	0.45	

Notes :

- \* Pulse width ≤ 300 μs, duty cycle ≤ 2 %
- \*\* Surface Mounted on minimum footprint pad area.
- \*\*\* Limited by bonding wire

### 4. Ordering Code

Product Name	Package	Reel Size	Tape width	Quantity	Note
FDBL86361-F085	TOLL-8L			2000	

Note: NHCX defines " Green " as lead-free ( RoHS compliant ) and halogen free ( Br or Cl does not exceed 900 ppm by weight in homogeneous material and total of Br and Cl does not exceed 1500 ppm by weight; Follow IEC 61249-2-21 and IPC / JEDEC J-STD-020C )

## 5. Electrical Characteristics ( $T_A=25^\circ$ Unless Otherwise Noted )

Symbol	Parameter	Conditions	Min	Typ	Max	Unit
<b>Static Characteristics</b>						
$BV_{DSS}$	Drain-Source Breakdown Voltage	$V_{GS} = 0\text{ V}, I_{DS} = 250\ \mu\text{A}$	85	95	-	V
$V_{GS(th)}$	Gate Threshold Voltage	$V_{DS} = V_{GS}, I_{DS} = 250\ \mu\text{A}$	2	-	4	V
$I_{DSS}$	Drain Leakage Current	$V_{DS} = 80\text{ V}, V_{GS} = 0\text{ V}$	-	-	1	$\mu\text{A}$
$I_{GSS}$	Gate Leakage Current	$V_{GS} = 0\text{ V}, V_{GS} = \pm 20\text{ V}$	-	-	$\pm 100$	nA
$R_{DS(ON)}^a$	On-State Resistance	$V_{GS} = 10.0\text{ V}, I_{DS} = 50\text{ A}$	-	1.2	1.4	$\text{m}\Omega$
<b>Diode Characteristics</b>						
$V_{SD}^a$	Diode Forward Voltage	$I_{SD} = 50\text{ A}, V_{GS} = 0\text{ V}$	-	-	1.2	V
$t_{rr}$	Reverse Recovery Time	$I_{DS} = 50\text{ A}, V_{GS} = 0\text{ V}$ $dI_{SD}/dt = 100\text{ A}/\mu\text{s}$	-	120	-	nS
$Q_{rr}$	Reverse Recovery Charge		-	360	-	nC
<b>Dynamic Characteristics<sup>b</sup></b>						
$C_{iss}$	Input Capacitance	$V_{GS} = 0\text{ V}, V_{DS} = 50\text{ V}$ Frequency = 1 MHz	-	14490	-	pF
$C_{oss}$	Output Capacitance		-	2350	-	
$C_{rss}$	Reverse Transfer Capacitance		-	472	-	
$t_d(on)$	Turn-on Delay Time	$V_{DS} = 50\text{ V}, V_{GEN} = 10\text{ V},$ $R_G = 4.5\ \Omega, R_L = 1\ \Omega,$ $I_{DS} = 50\text{ A}$	-	39	-	nS
$t_r$	Turn-on Rise Time		-	122	-	
$t_d(off)$	Turn-off Delay Time		-	115	-	
$t_f$	Turn-off Fall Time		-	137	-	
<b>Gate Charge Characteristics<sup>b</sup></b>						
$Q_g$	Total Gate Charge	$V_{DS} = 50\text{ V}, V_{GS} = 10\text{ V},$ $I_{DS} = 50\text{ A}$	-	240	-	nC
$Q_{gs}$	Gate-Source Charge		-	56	-	
$Q_{gd}$	Gate-Drain Charge		-	60	-	

Notes :

a : Pulse test ; pulse width  $\leq 300\ \mu\text{s}$ , duty cycle  $\leq 2\%$

b : Guaranteed by design, not subject to production testing

## 6. Typical Characteristics

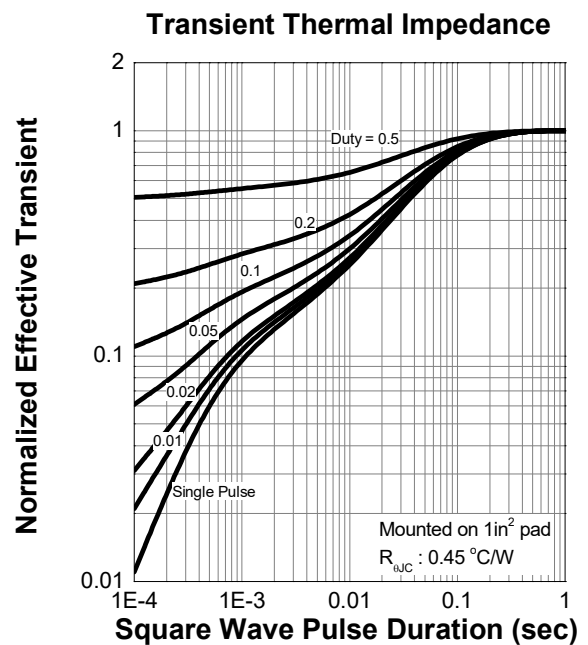
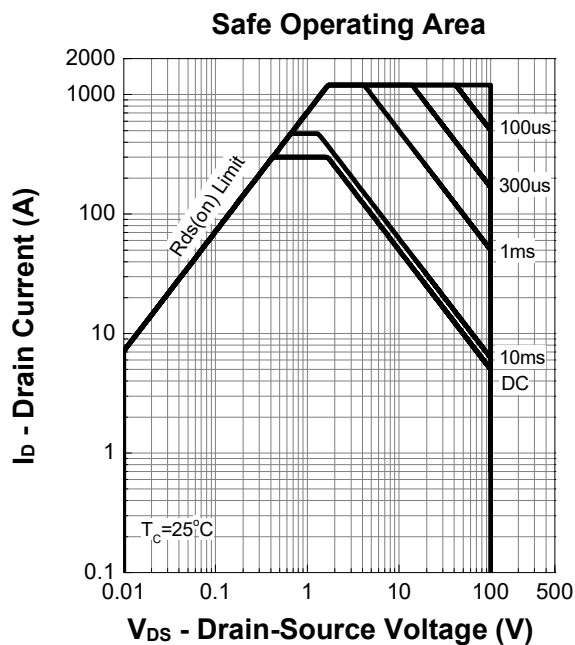
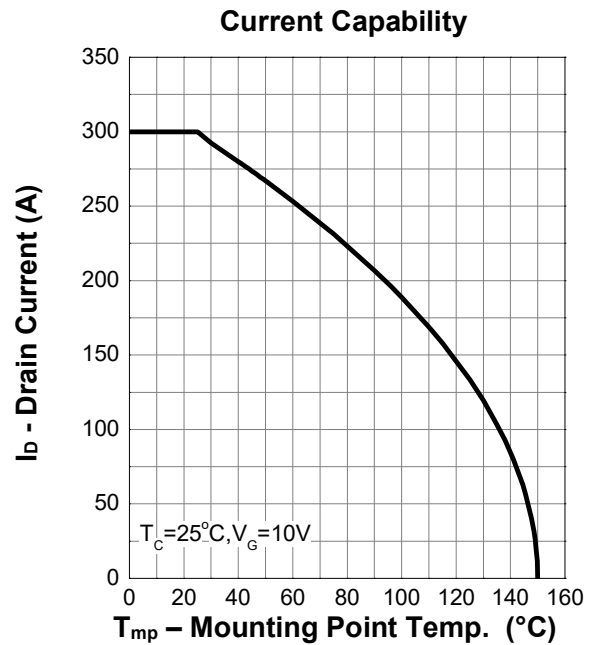
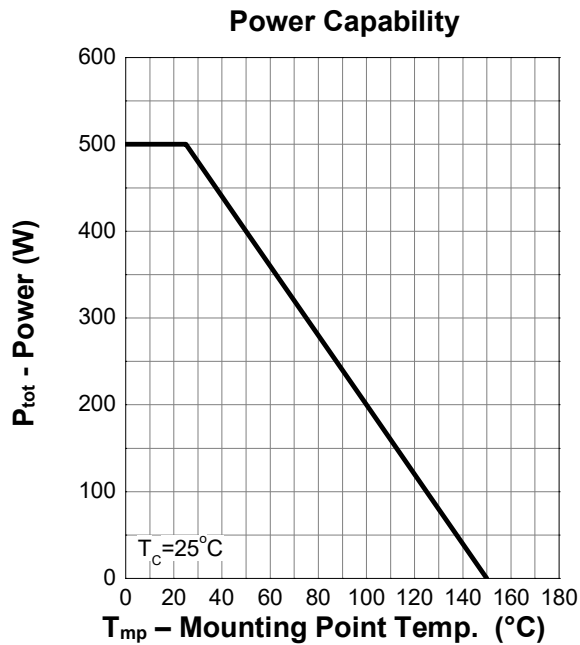

## 6. Typical Characteristics (cont.)

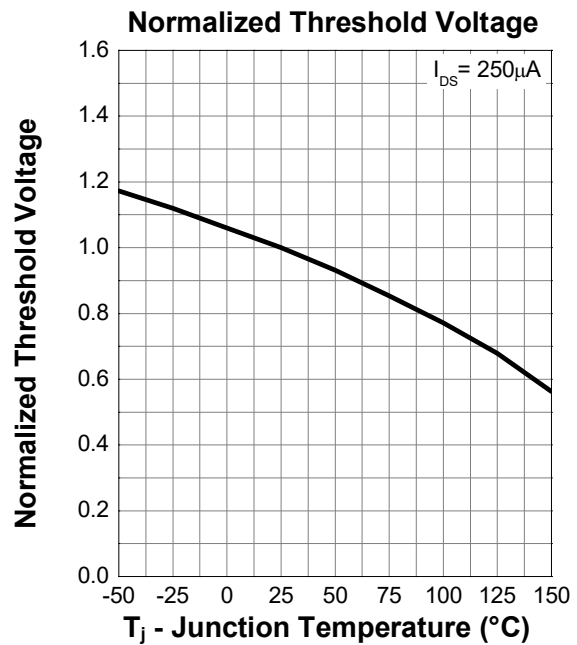
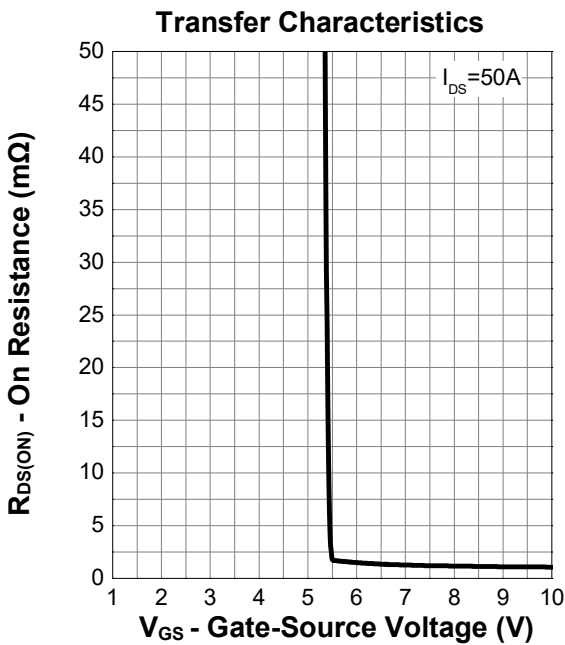
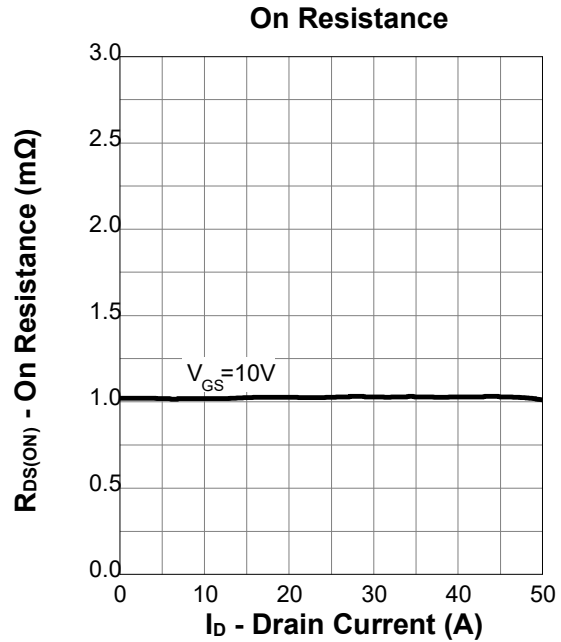
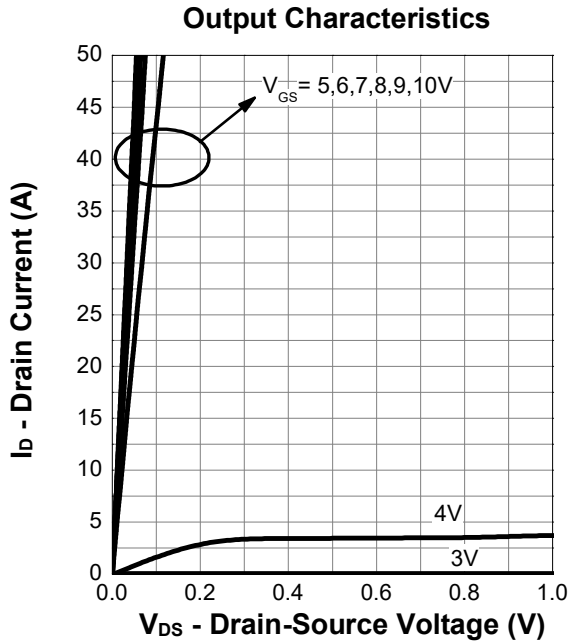

## 6. Typical Characteristics (cont.)

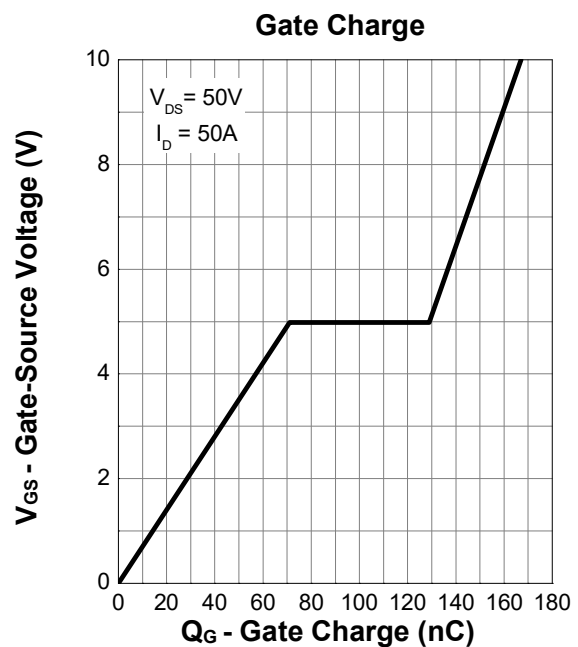
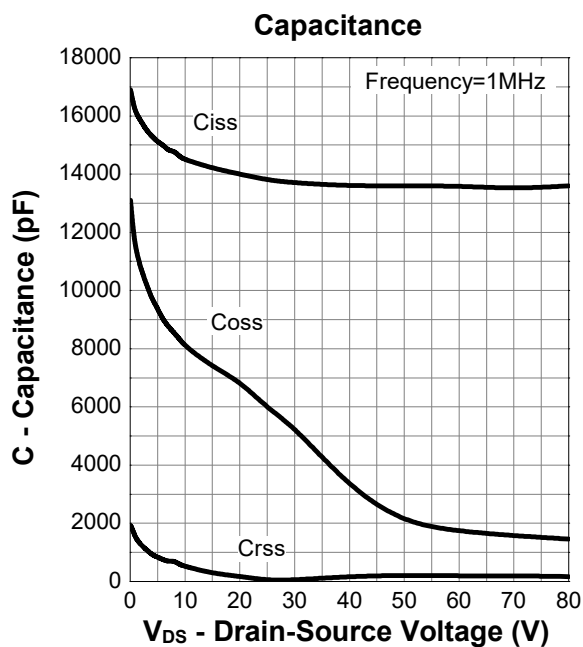
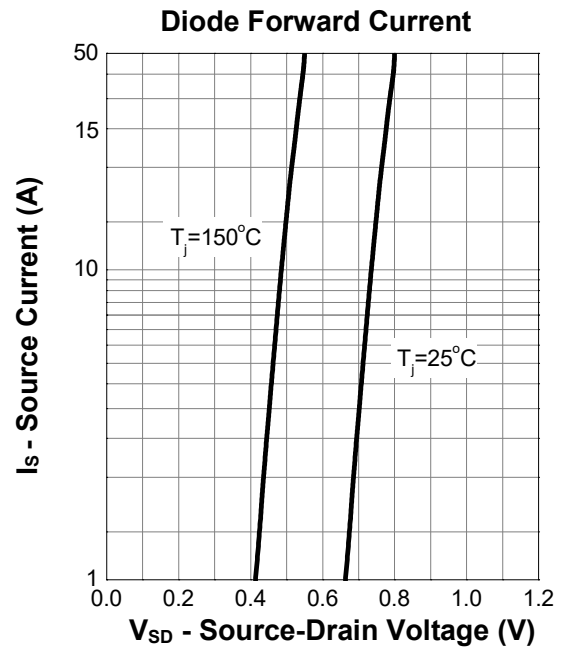
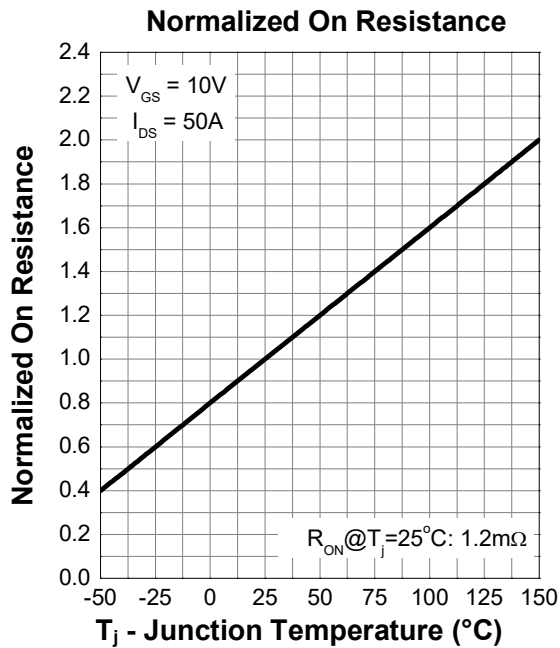

## 7. Package Dimensions

TOLL-8L Package

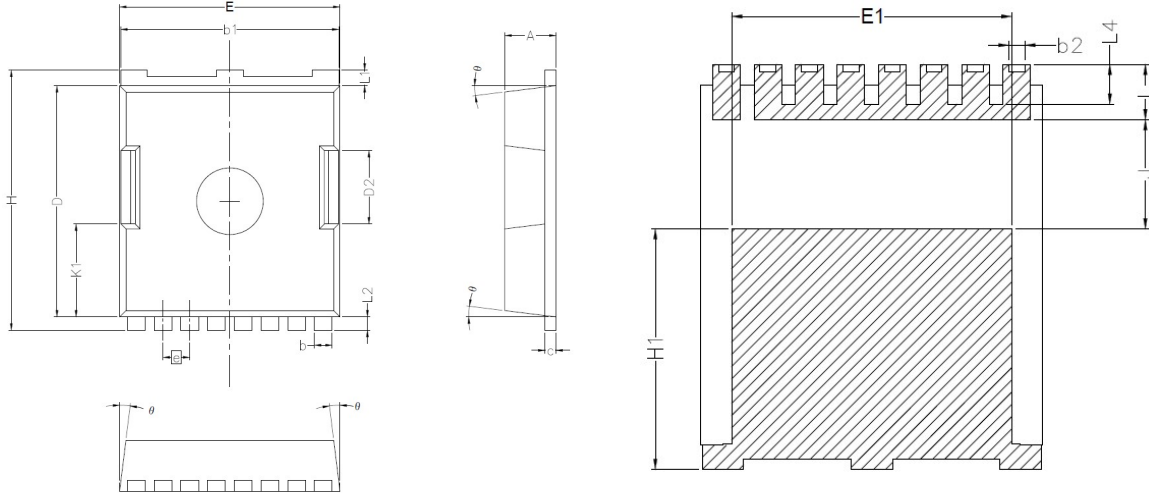

Symbol	Dimensions In Millimeters	
	MIN.	MAX.
A	2.20	2.40
b	0.70	0.90
b1	9.70	9.90
b2	0.42	0.50
c	0.40	0.60
D	10.28	10.58
D2	3.10	3.50
E	9.70	10.10
E1	7.90	8.30
e	1.20BSC	
H	11.48	11.88
H1	6.75	7.15
N	8	
J	3.00	3.30
K1	3.98	4.38
L	1.40	1.80
L1	0.60	0.80
L2	0.50	0.70
L4	1.00	1.30
$\theta$	4°	10°