

6A Single Phase Glass passivated Bridge Rectifiers

RECTIFIER Reverse Voltage - 50 to 1000 V

Forward Current – 6A

FEATURES

- ◆ The plastic package carries Underwriters Laboratory Flammability Classification 94V-0
- ◆ Idea for printed circuit board
- ◆ Glass passivated Junction chip
- ◆ Low reverse leakage
- ◆ High forward surge current capability
- ◆ High temperature soldering guaranteed
250°C/10 seconds at terminals

MECHANICAL DATA

- ◆ Case : Molded plastic body
- ◆ Terminals : Solder plated, solderable per MIL-STD-750, Method 2026
- ◆ Polarity : Polarity symbol marking on body
- ◆ Mounting Position : Any

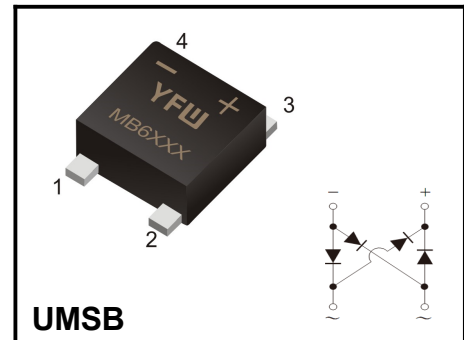

Marking Code	
MSB60A	MB60A
MSB60B	MB60B
MSB60D	MB60D
MSB60G	MB60G
MSB60J	MB60J
MSB60K	MB60K
MSB60M	MB60M

Maximum Ratings And Electrical Characteristics

Ratings at 25°C ambient temperature unless otherwise specified. Single phase half-wave 60Hz, resistive or inductive load, for capacitive load current derate by 20%.

Parameter	Symbols	MSB60A	MSB60B	MSB60D	MSB60G	MSB60J	MSB60K	MSB60M	Units
Maximum Repetitive Peak Reverse Voltage	V_{RRM}	50	100	200	400	600	800	1000	V
Maximum RMS voltage	V_{RMS}	35	70	140	280	420	560	700	V
Maximum DC Blocking Voltage	V_{DC}	50	100	200	400	600	800	1000	V
Maximum average forward rectified current at $T_L=100^\circ\text{C}$	$I_{(AV)}$	6.0							A
Peak forward surge current, 8.3ms single half sine-wave superimposed on rated load	I_{FSM}	175							A
Rating for fusing ($t=8.3\text{ms}$, $T_a=25^\circ\text{C}$)	I_t^2	127							A^2s
Maximum instantaneous forward voltage at 6.0A	V_F	1.10							V
Maximum DC Reverse Current $T_a=25^\circ\text{C}$ at Rated DC Blocking Voltage $T_a=125^\circ\text{C}$	I_R	5.0 500							μA
Typical junction capacitance (Note 1)	C_j	45							pF
Typical thermal resistance	R_{qJA}	55							$^\circ\text{C/W}$
Operating and Storage Temperature Range	T_j, T_{stg}	-55 ~ +150							$^\circ\text{C}$

Note: 1. Measured at 1MHz and applied reverse voltage of 4.0V D.C.

Ratings And Characteristic Curves

FIG. 1- DERATING CURVE OUTPUT RECTIFIED CURRENT

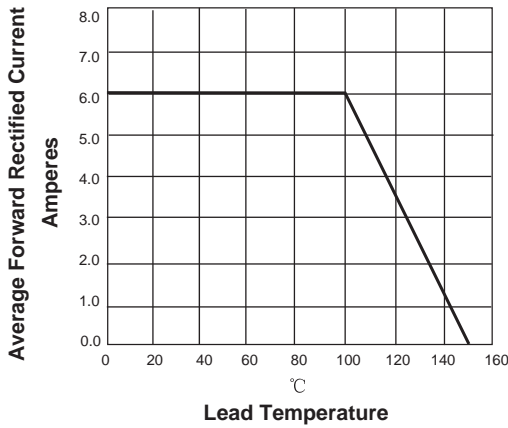

FIG. 2-MAXIMUM NON-REPETITIVE PEAK FORWARD SURGE CURRENT PERLEG

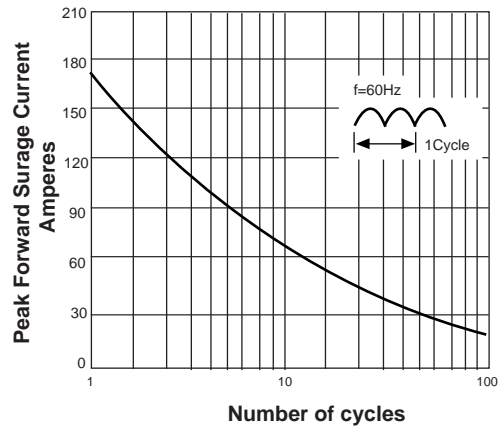

FIG. 3-TYPICAL FORWARD VOLTAGE CHARACTERISTICS

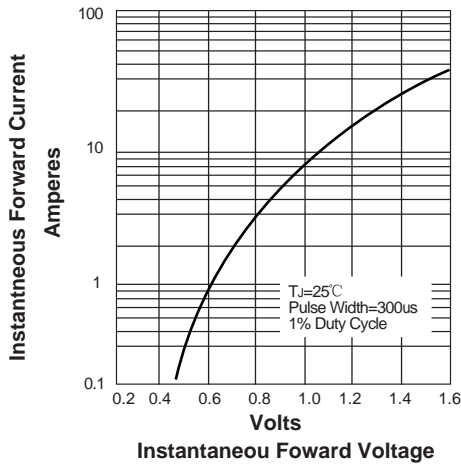
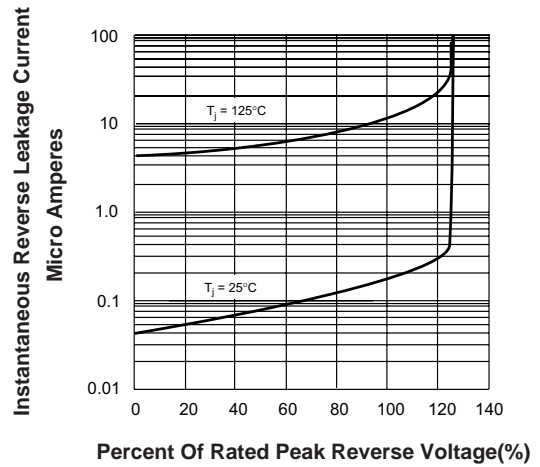
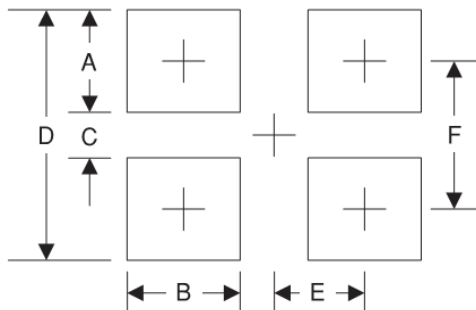

FIG. 4-TYPICAL REVERSE LEAKAGE CHARACTERISTICS



Suggested Pad Layout



Symbol	Unit (mm)	Unit (inch)
A	1.8	0.071
B	2.0	0.078
C	5.50	0.216
D	9.15	0.360
E	2.6	0.102
F	7.35	0.289

Package Outline

UMSB

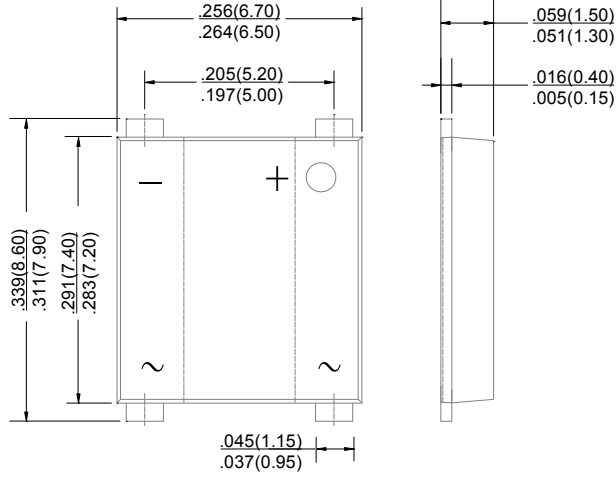

Dimensions in inches and (millimeters)

Summary of Packing Options

Package	Packing Description	Packing Quantity	Industry Standard
UMSB	Tape/Reel, 13" reel	3000	EIA-481-1