

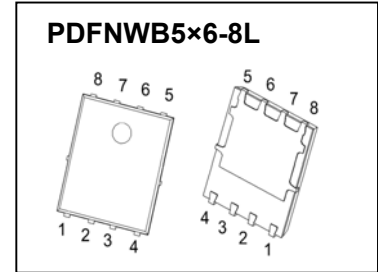

JIANGSU CHANGJING ELECTRONICS TECHNOLOGY CO., LTD  
**PDFNWB5×6-8L Plastic-Encapsulate MOSFET**

**CJAC1R3SN04C N-Channel Power MOSFET**

$V_{(BR)DSS}$	$R_{DS(on)TYP}$	$I_D$
40V	1.0mΩ@10V	190A
	1.4mΩ@4.5V	



**DESCRIPTION**

The N-Channel enhancement mode power field effect transistors is using SGT technology. This advanced technology has been especially tailored to minimize on-state resistance, provide superior switching performance, and withstand high energy pulse in the avalanche and commutation mode. These devices are well suited for high efficiency fast switching applications.

**FEATURES**

- Battery switch
- Load switch
- High density cell design for ultra low  $R_{DS(ON)}$
- Fully characterized avalanche voltage and current
- Good stability and uniformity with high  $E_{AS}$
- Excellent package for good heat dissipation

**APPLICATIONS**

- SMPS and general purpose applications
- Hard switched and high frequency circuits
- Uninterruptible Power Supply

**MARKING**

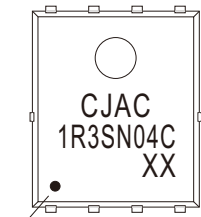

CJAC1R3SN04C = Part No.  
 Solid dot = Pin1 indicator.  
 XX = Code.

**EQUIVALENT CIRCUIT**

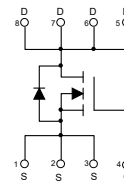

**MAXIMUM RATINGS (  $T_J=25^{\circ}C$  unless otherwise noted )**

Parameter	Symbol	Limit	Unit
Drain-Source Voltage	$V_{DS}$	40	V
Gate-Source Voltage	$V_{GS}$	±20	V
Continuous Drain Current	$I_D$ ①	190	A
Pulsed Drain Current	$I_{DM}$ ①②	760	A
Single Pulsed Avalanche Energy	$E_{AS}$ ③	670	mJ
Power Dissipation	$P_D$ ①	96	W
Thermal Resistance from Junction to Ambient	$R_{\theta JA}$ ⑤	62.5	°C/W
Thermal Resistance from Junction to Case	$R_{\theta JC}$ ①	1.3	°C/W
Operating Junction and Storage Temperature Range	$T_J, T_{STG}$	-55~+150	°C

# MOSFET ELECTRICAL CHARACTERISTICS

$T_J=25^{\circ}\text{C}$  unless otherwise specified

Parameter	Symbol	Test Condition	Min	Typ	Max	Unit	
<b>Off characteristics</b>							
Drain-source breakdown voltage	$V_{(BR)DSS}$	$V_{GS} = 0V, I_D = 1mA$	40	-	-	V	
Zero gate voltage drain current	$I_{DSS}$	$V_{DS} = 32V, V_{GS} = 0V$	$T_J = 25^{\circ}\text{C}$	-	-	1.0	$\mu\text{A}$
			$T_J = 125^{\circ}\text{C}$	-	-	100	
Gate-body leakage current	$I_{GSS}$	$V_{DS} = 0V, V_{GS} = \pm 20V$	-	-	$\pm 100$	nA	
<b>On characteristics</b> <sup>④</sup>							
Gate-threshold voltage	$V_{GS(th)}$	$V_{DS} = V_{GS}, I_D = 250\mu\text{A}$	1.0	1.6	2.5	V	
Static drain-source on-state resistance	$R_{DS(on)}$	$V_{GS} = 10V, I_D = 30A$	-	1.0	1.25	m $\Omega$	
		$V_{GS} = 4.5V, I_D = 30A$	-	1.4	2.0	m $\Omega$	
<b>Dynamic characteristics</b>							
Input capacitance	$C_{iss}$	$V_{DS} = 20V, V_{GS} = 0V, f = 100\text{kHz}$	-	5310	-	$\text{pF}$	
Output capacitance	$C_{oss}$		-	1850	-		
Reverse transfer capacitance	$C_{rss}$		-	65	-		
Gate resistance	$R_g$	$f = 1\text{MHz}$	-	6.2	-	$\Omega$	
<b>Switching characteristics</b>							
Total gate charge	$Q_g$	$V_{GS} = 4.5V, V_{DS} = 20V, I_D = 75A$	-	35.3	-	nC	
Total gate charge	$Q_g$	$V_{GS} = 10V, V_{DS} = 20V, I_D = 75A$	-	78.5	-		
Gate-source charge	$Q_{gs}$		-	14.5	-		
Gate-drain charge	$Q_{gd}$		-	15.7	-		
Turn-on delay time	$t_{d(on)}$	$V_{DS} = 20V, V_{GS} = 10V, R_L = 0.4\Omega, R_g = 2.5\Omega$	-	5	-	ns	
Turn-on rise time	$t_r$		-	22	-		
Turn-off delay time	$t_{d(off)}$		-	78	-		
Turn-off fall time	$t_f$		-	75	-		
<b>Drain-Source Diode Characteristics</b>							
Drain-source diode forward voltage	$V_{SD}$ <sup>④</sup>	$V_{GS} = 0V, I_S = 30A$	-	-	1.3	V	
Continuous drain-source diode forward current	$I_S$ <sup>①</sup>		-	-	190	A	
Pulsed drain-source diode forward current	$I_{SM}$ <sup>①②</sup>		-	-	760	A	
Reverse recovery time	$t_{rr}$	$di_S/dt = 100A/\mu\text{s}, I_S = 30A, V_{DD} = 30V$	-	137	-	ns	
Reverse recovery charge	$Q_{rr}$		-	438	-	nC	

Notes:

- $T_C = 25^{\circ}\text{C}$ .
- Limited only by maximum temperature allowed.
- $V_{DD} = 20V, V_{GS} = 10V, L = 0.5\text{mH}, R_g = 25\Omega$  Starting  $T_J = 25^{\circ}\text{C}$ .
- Pulse Test : Pulse Width  $\leq 380\mu\text{s}$ , duty cycle  $\leq 2\%$ .
- Device mounted on 1 in<sup>2</sup> FR-4 board with 2oz. single-sided Copper, in a still air environment with  $T_A = 25^{\circ}\text{C}$ .

# Typical Characteristics ( $T_J = 25^\circ\text{C}$ , unless otherwise specified)

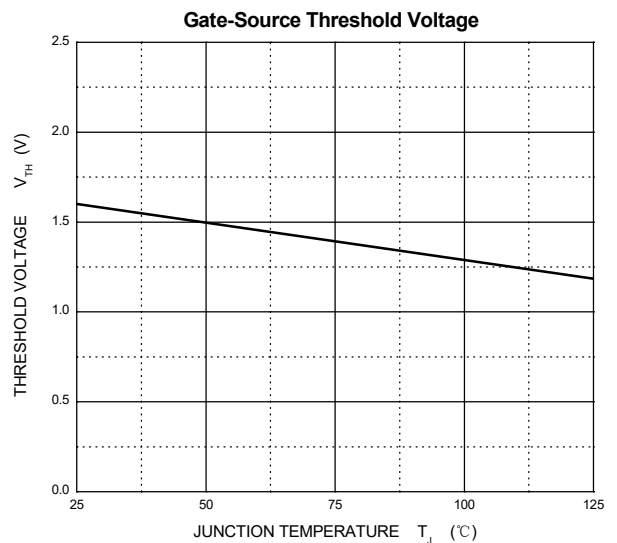
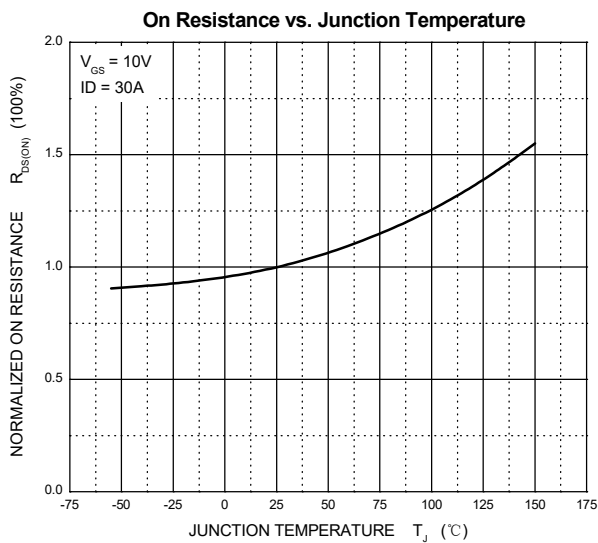
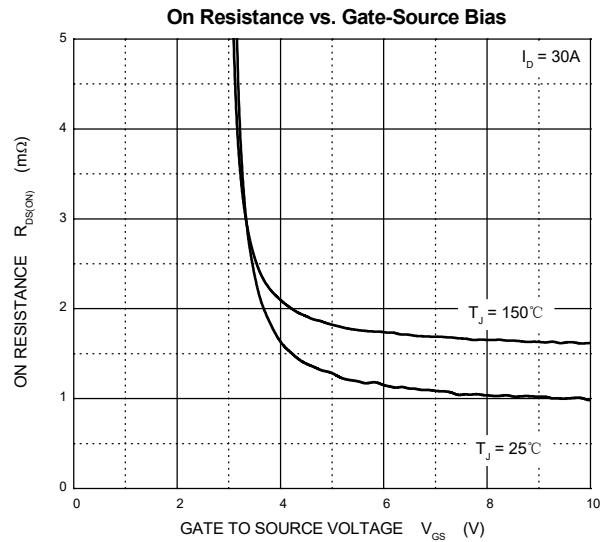
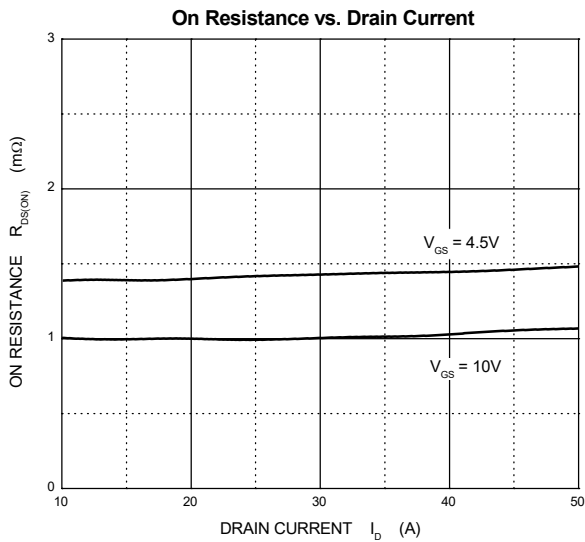
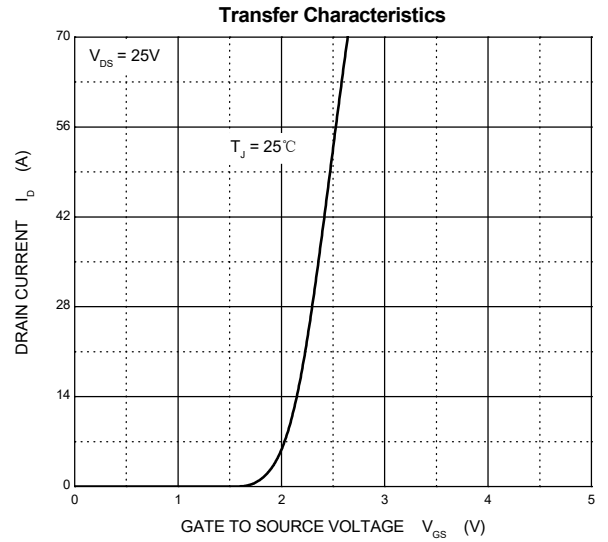
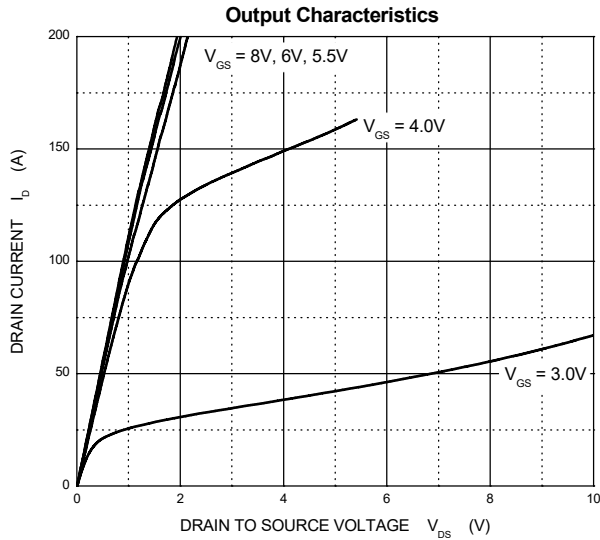

# Typical Characteristics ( $T_J = 25^\circ\text{C}$ , unless otherwise specified)

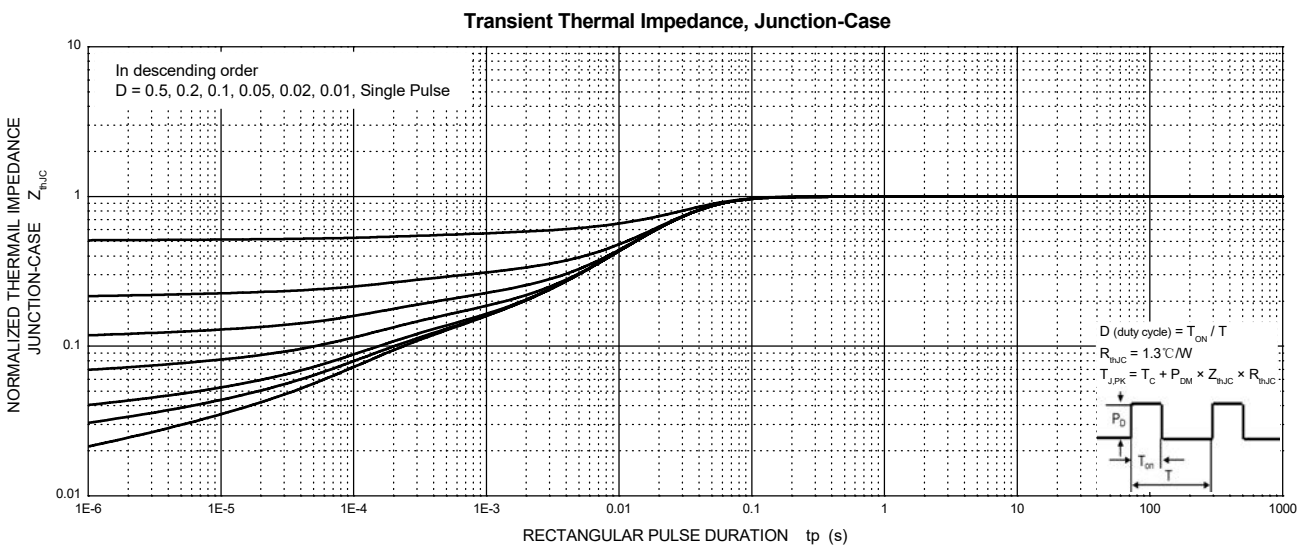
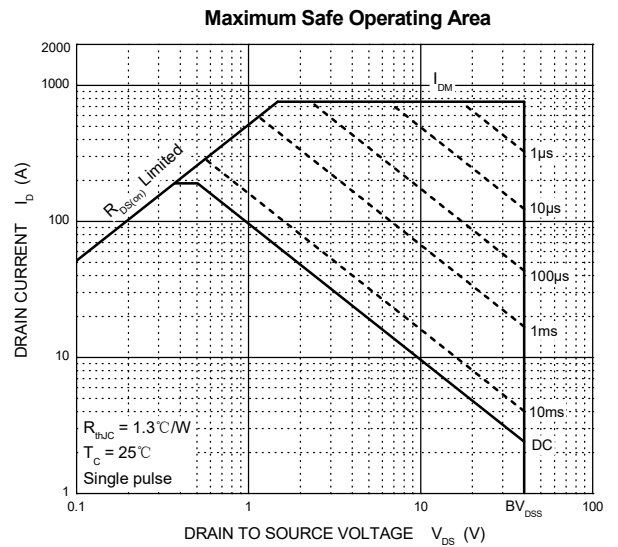
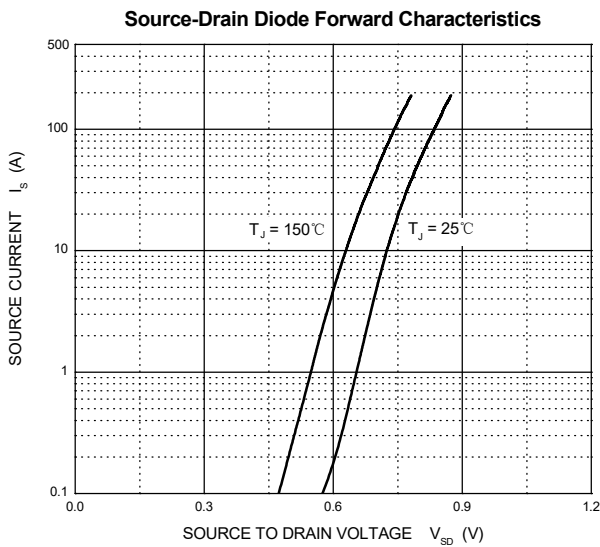
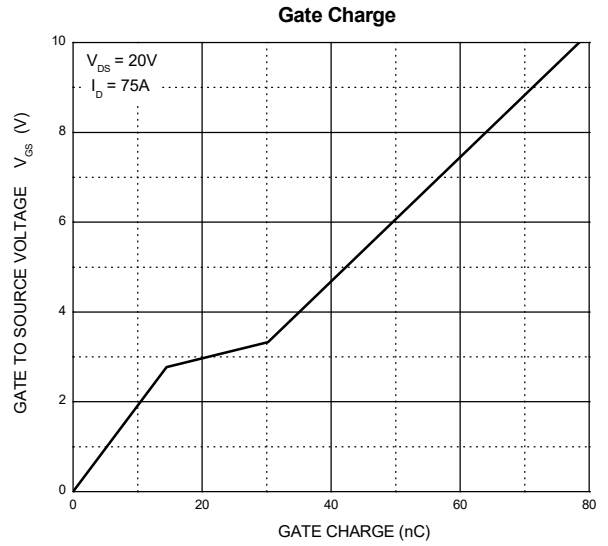
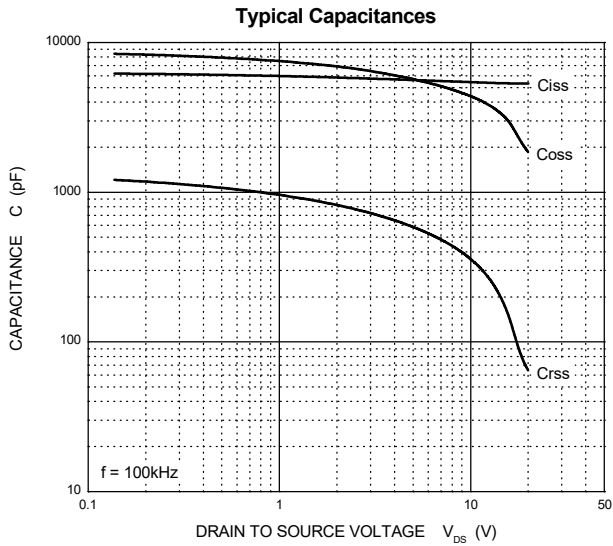

# TEST CIRCUIT AND WAVEFORMS

## Gate Charge

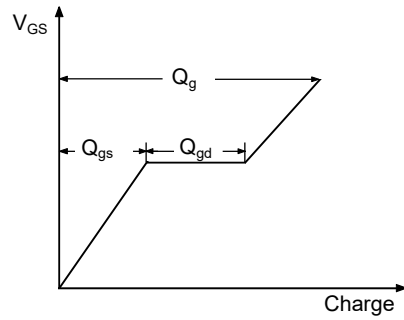
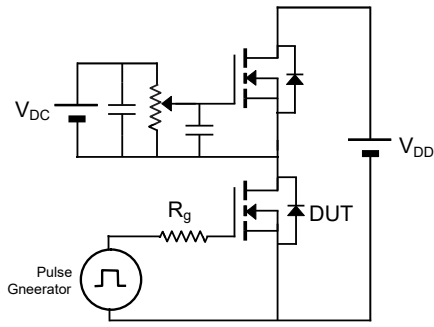

## Resistive Load Switching Time

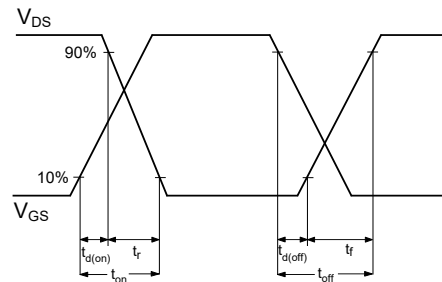
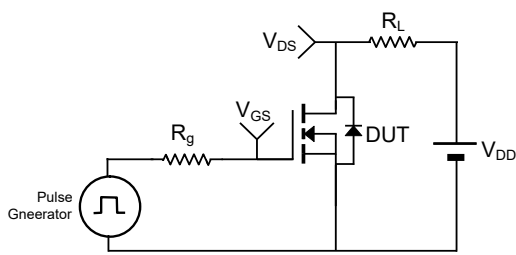

## Un-clamped Inductive Load Switching

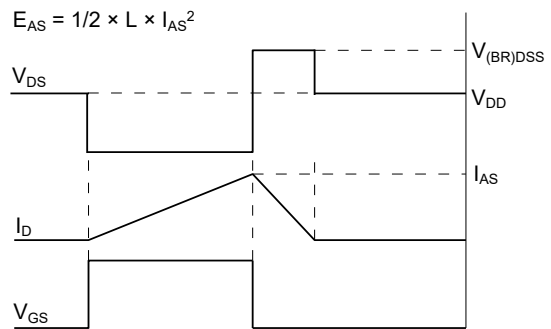
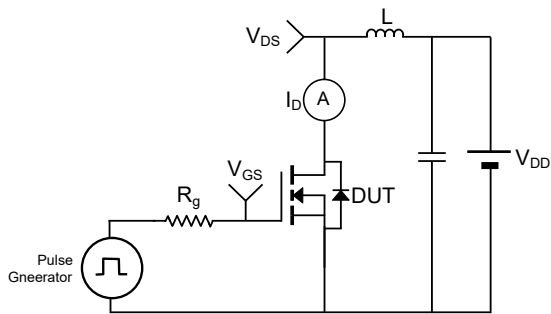

## Drain-Source Body Diode Reverse Recovery

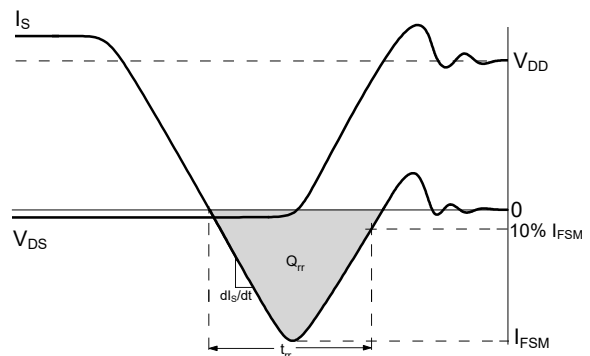
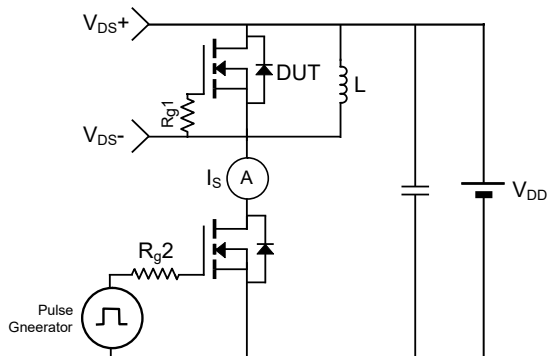

## PDFNWB5x6-8L-B Package Outline Dimensions

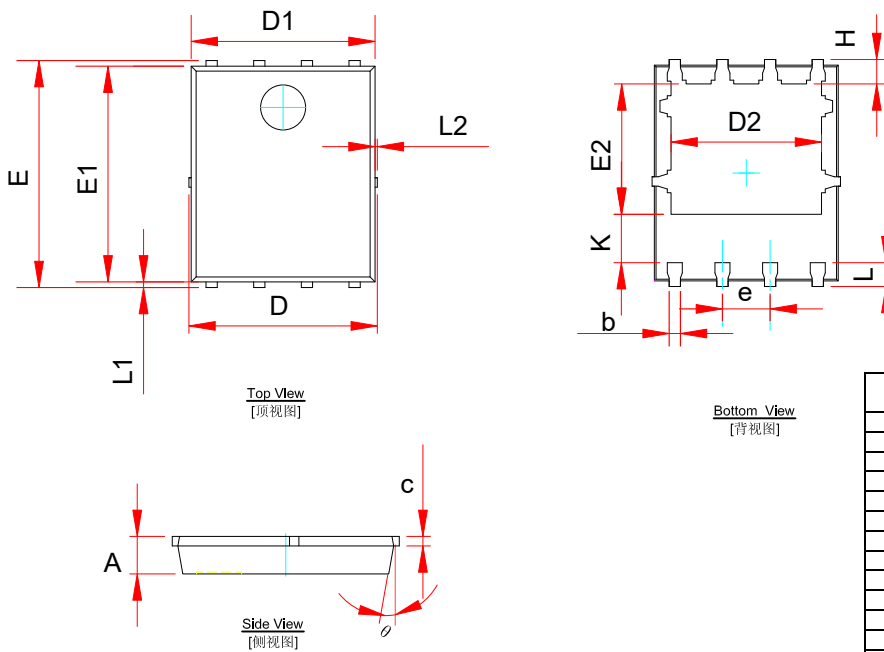

Symbol	Dimensions In Millimeters		Dimensions In Inches	
	Min.	Max.	Min.	Max.
A	0.900	1.100	0.035	0.043
b	0.200	0.400	0.008	0.016
c	0.210	0.340	0.008	0.013
D		5.100		0.201
D1	4.800	5.000	0.189	0.197
D2	3.910	4.110	0.154	0.162
e	1.27 BSC		0.050 BSC	
E	5.900	6.100	0.232	0.240
E1	5.650	5.850	0.222	0.230
E2	3.375	3.575	0.133	0.141
H	0.550	0.750	0.022	0.030
K	1.200		0.047	
L	0.550	0.750	0.022	0.030
L1	0.050	0.250	0.002	0.010
L2		0.120		0.005
θ	8°	12°	8°	12°

## PDFNWB5x6-8L Suggested Pad Layout

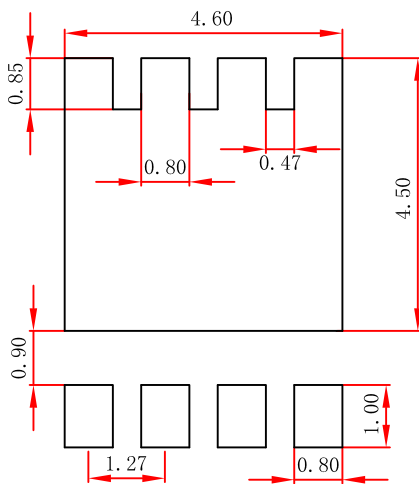

**Note:**

1. Controlling dimension: in millimeters.
2. General tolerance:  $\pm 0.05\text{mm}$ .
3. The pad layout is for reference purposes only.

**NOTICE**

JSCJ reserves the right to make modifications, enhancements, improvements, corrections or other changes without further notice to any product herein. JSCJ does not assume any liability arising out of the application or use of any product described herein.

# PDFNWB5×6 Tape and Reel

## PDFNWB5×6-8L Embossed Carrier Tape

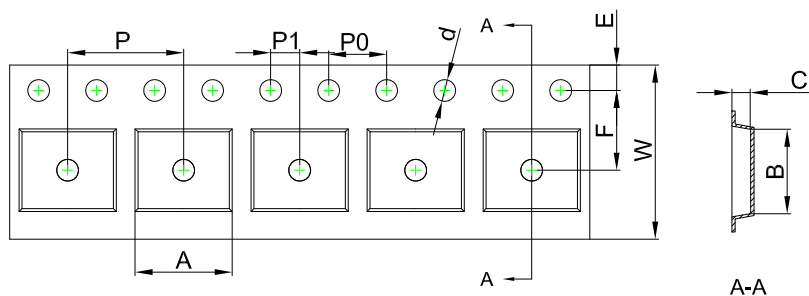

**Packaging Description:**  
**PDFNWB5×6-8L** parts are shipped in tape. The carrier tape is made from a dissipative (carbon filled) polycarbonate resin. The cover tape is a multilayer film (Heat Activated Adhesive in nature) primarily composed of polyester film, adhesive layer, sealant, and anti-static sprayed agent. These reeled parts in standard option are shipped with 5,000 units per 13" or 33.0 cm diameter reel. The reels are clear in color and is made of polystyrene plastic (anti-static coated).

Dimensions are in millimeter										
Pkg type	A	B	C	d	E	F	P0	P	P1	W
PDFNWB5×6-8L	6.30	5.30	1.10	Ø1.50	1.75	5.50	4.00	8.00	2.00	12.00

## PDFNWB5×6-8L Tape Leader and Trailer

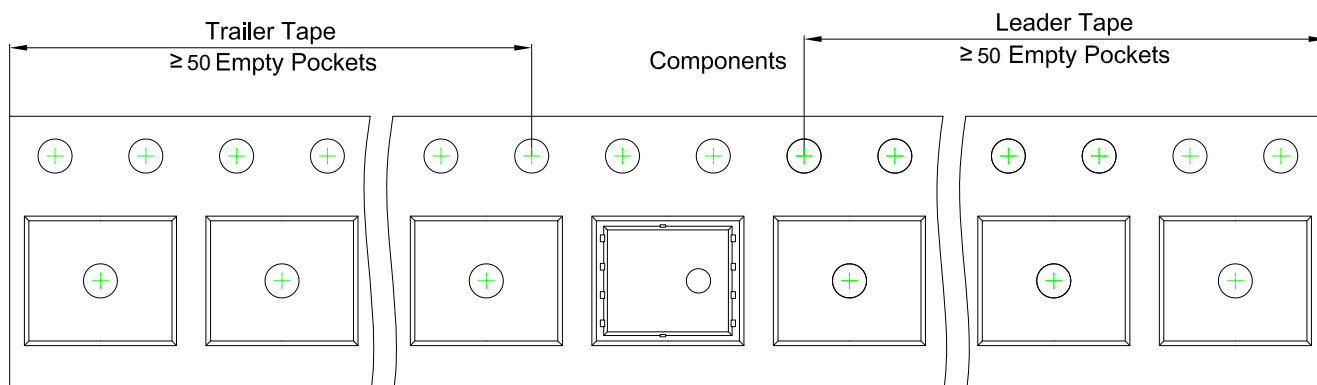

## PDFNWB5×6-8L Reel

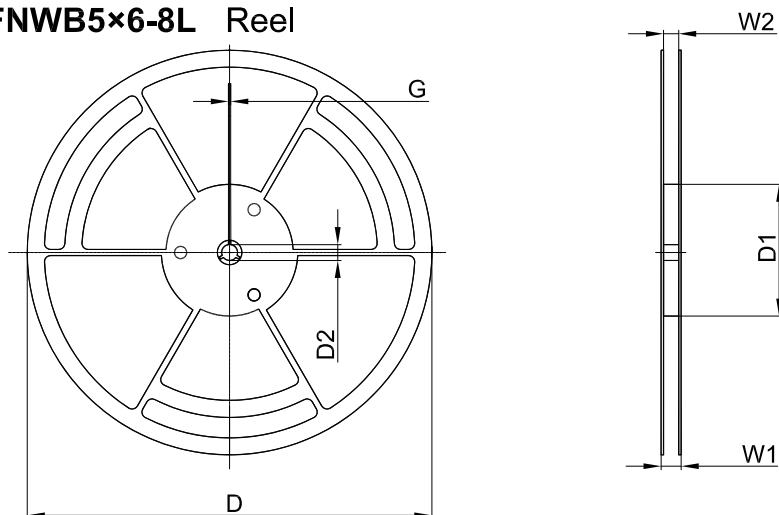

Dimensions are in millimeter						
Reel Option	D	D1	D2	G	W1	W2
13"Dia	Ø330.00	100.00	13.00	1.90	17.60	12.40

REEL	Reel Size	Box	Box Size(mm)	Carton	Carton Size(mm)
5,000 pcs	13 inch	5,000 pcs	340×336×29	50,000 pcs	353×346×365