

TO-126 Plastic-Encapsulate Transistors

BD234 / BD236 / BD238 TRANSISTOR (PNP)

FEATURES

- Complement to BD233/BD235/BD237 respectively

MARKING

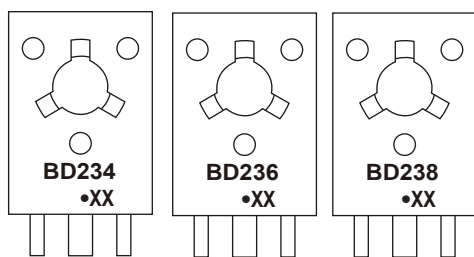

BD234, BD236, BD238 = Device code
 Solid dot = Green molding compound device,
 if none, the normal device
 XX = Code

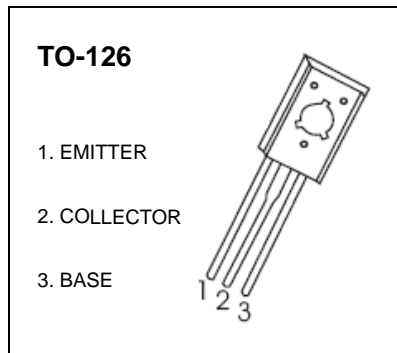

Equivalent Circuit

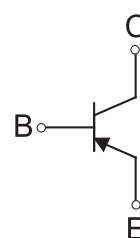

ORDERING INFORMATION

Part Number	Package	Packing Method	Pack Quantity
BD234	TO-126	Bulk	200pcs/Bag
BD236	TO-126	Bulk	200pcs/Bag
BD238	TO-126	Bulk	200pcs/Bag
BD234-TU	TO-126	Tube	60pcs/Tube
BD236-TU	TO-126	Tube	60pcs/Tube
BD238-TU	TO-126	Tube	60pcs/Tube

MAXIMUM RATINGS (T_a=25°C unless otherwise noted)

Symbol	Parameter		Value	Unit
V _{CBO}	Collector-Base Voltage	BD234	-45	V
		BD236	-60	
		BD238	-100	
V _{CEO}	Collector-Emitter Voltage	BD234	-45	V
		BD236	-60	
		BD238	-80	
V _{EBO}	Emitter-Base Voltage		-5	V
I _c	Collector Current –Continuous		-2	A
P _c	Collector Dissipation		1.25	W
P _c	Collector Dissipation (T _c =25°C)		25	W
R _{θJA}	Thermal Resistance from Junction to Ambient		100	°C/W
R _{θJC}	Thermal Resistance from Junction to Case		5	°C/W
T _J , T _{stg}	Operation Junction and Storage Temperature Range		-55~+150	°C

ELECTRICAL CHARACTERISTICS

$T_a=25\text{ }^\circ\text{C}$ unless otherwise specified

Parameter	Symbol	Test conditions	Min	Max	Unit
Collector-base breakdown voltage BD234 BD236 BD238	$V_{(BR)CBO}$	$I_C=-1\text{mA}, I_E=0$	-45 -60 -100		V
Collector-emitter breakdown voltage BD234 BD236 BD238	$V_{(BR)CEO}$	$I_C=-100\text{mA}, I_B=0$	-45 -60 -80		V
Emitter-base breakdown voltage	$V_{(BR)EBO}$	$I_E=-1\text{mA}, I_C=0$	-5		V
Collector cut-off current BD234 BD236 BD238	I_{CBO}	$V_{CB}=-45\text{V}, I_E=0$ $V_{CB}=-60\text{V}, I_E=0$ $V_{CB}=-100\text{V}, I_E=0$		-100	μA
Emitter cut-off current	I_{EBO}	$V_{EB}=-5\text{V}, I_C=0$		-1	mA
DC current gain	$h_{FE(1)}$	$V_{CE}=-2\text{V}, I_C=-150\text{mA}$	40		
	$h_{FE(2)}$	$V_{CE}=-2\text{V}, I_C=-1\text{A}$	25		
Collector-emitter saturation voltage	$V_{CE(sat)}$	$I_C=-1\text{A}, I_B=-100\text{mA}$		-0.6	V
Transition frequency	f_T	$V_{CE}=-10\text{V}, I_C=-250\text{mA},$ $f=10\text{MHz}$	3		MHz

Typical Characteristics

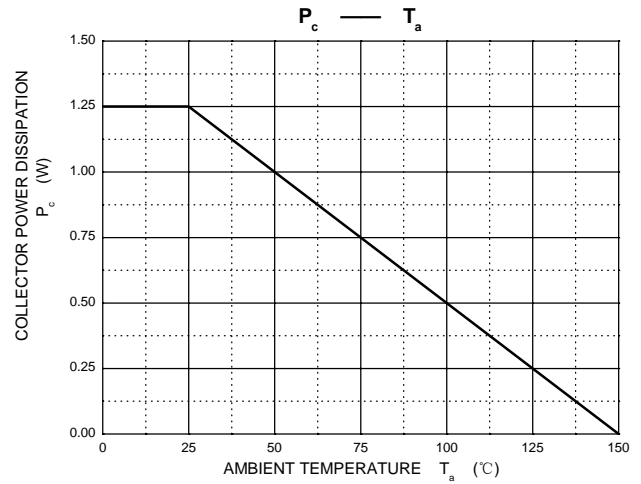
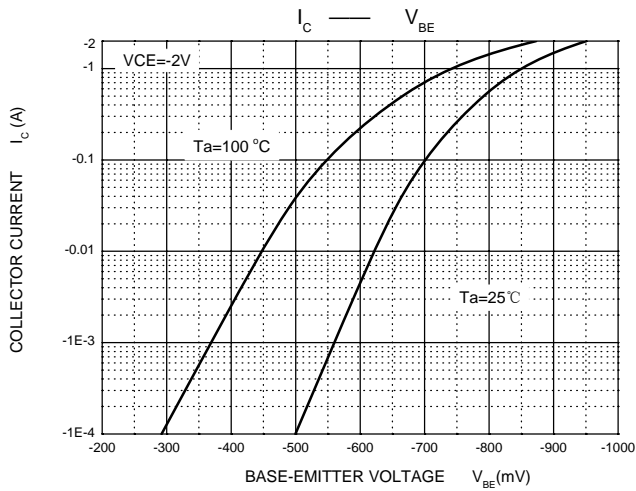
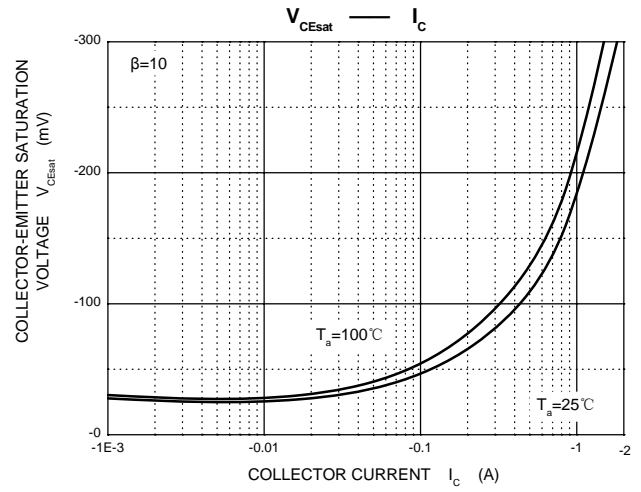
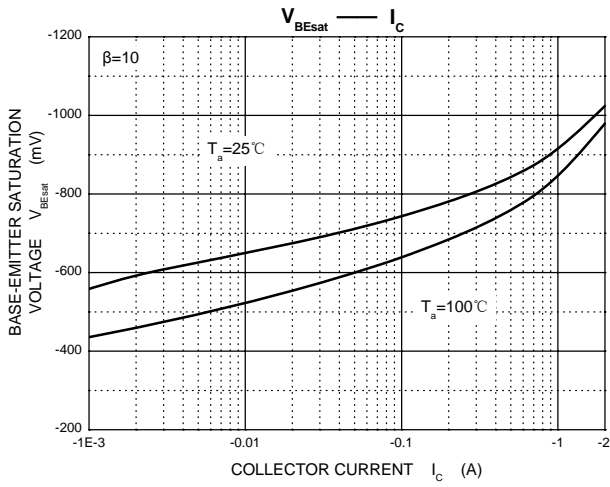
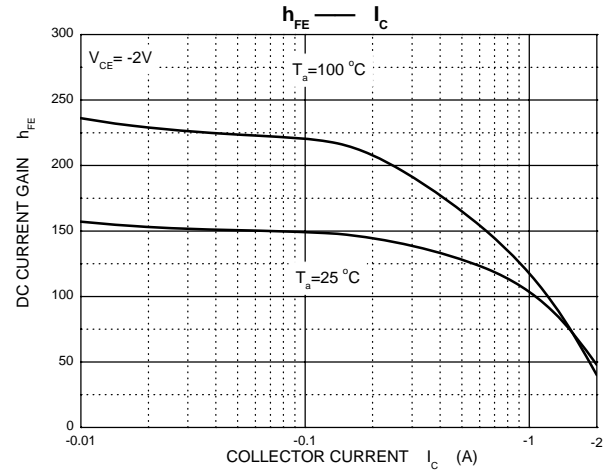
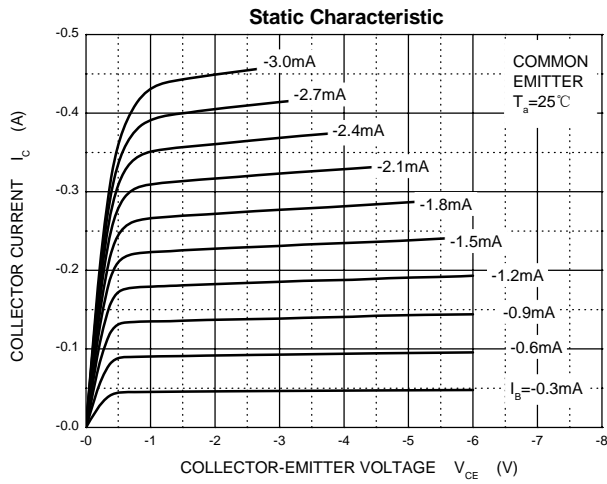

TO-126 Package Outline Dimensions



Symbol	Dimensions In Millimeters		Dimensions In Inches	
	Min	Max	Min	Max
A	2.500	2.900	0.098	0.114
A1	1.100	1.500	0.043	0.059
b	0.660	0.860	0.026	0.034
b1	1.170	1.370	0.046	0.054
c	0.450	0.600	0.018	0.024
D	7.400	7.800	0.291	0.307
E	10.600	11.000	0.417	0.433
e	2.290 TYP		0.090 TYP	
e1	4.480	4.680	0.176	0.184
h	0.000	0.300	0.000	0.012
L	15.300	15.700	0.602	0.618
L1	2.100	2.300	0.083	0.091
P	3.900	4.100	0.154	0.161
Φ	3.000	3.200	0.118	0.126