

## TO-92 Plastic-Encapsulate Transistors

### BC546 / BC547 / BC548 TRANSISTOR (NPN)

#### FEATURES

- High Voltage
- Complement to BC556,BC557,BC558

#### MARKING

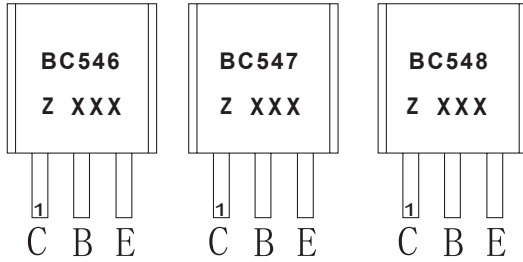

BC546,BC547,BC548=Device code

Z=Rank of  $h_{FE}$

XXX=Code

GXX=Green molding compound device

CXX=Normal molding compound device

#### TO-92

1. COLLECTOR
2. BASE
3. EMITTER

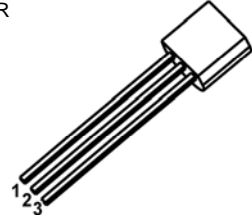

#### Equivalent Circuit

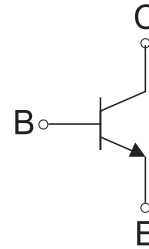

#### ORDERING INFORMATION

Part Number	Package	Packing Method	Pack Quantity
BC546	TO-92	Bulk	1000pcs/Bag
BC546-TA	TO-92	Tape	2000pcs/Box
BC547	TO-92	Bulk	1000pcs/Bag
BC547-TA	TO-92	Tape	2000pcs/Box
BC548	TO-92	Bulk	1000pcs/Bag
BC548-TA	TO-92	Tape	2000pcs/Box

#### MAXIMUM RATINGS ( $T_a=25^\circ\text{C}$ unless otherwise noted)

Symbol	Parameter	Value	Unit
$V_{CBO}$	Collector-Base Voltage	BC546	80
		BC547	50
		BC548	30
$V_{CEO}$	Collector-Emitter Voltage	BC546	65
		BC547	45
		BC548	30
$V_{EBO}$	Emitter-Base Voltage	BC546	6
		BC547	6
		BC548	5
$I_C$	Collector Current-Continuous	0.1	A
$P_C$	Collector Power Dissipation	625	mW
$R_{\theta JA}$	Thermal Resistance from Junction to Ambient	200	$^\circ\text{C}/\text{W}$
$T_J, T_{stg}$	Operation Junction and Storage Temperature Range	-55~+150	$^\circ\text{C}$

## ELECTRICAL CHARACTERISTICS

$T_a=25^\circ\text{C}$  unless otherwise specified

### ELECTRICAL CHARACTERISTICS ( $T_a=25^\circ\text{C}$ unless otherwise specified)

Parameter	Symbol	Test conditions	Min	Typ	Max	Unit
Collector-base breakdown voltage	BC546	$I_C=0.1\text{mA}, I_E=0$	80			V
	BC547		50			
	BC548		30			
Collector-emitter breakdown voltage	BC546	$I_C=1\text{mA}, I_B=0$	65			V
	BC547		45			
	BC548		30			
Emitter-base breakdown voltage	BC546	$I_E=10\mu\text{A}, I_C=0$	6			V
	BC547		6			
	BC548		5			
Collector cut-off current	BC546	$I_{CBO}$	$V_{CB}=70\text{V}, I_E=0$		0.1	$\mu\text{A}$
	BC547		$V_{CB}=50\text{V}, I_E=0$		0.1	$\mu\text{A}$
	BC548		$V_{CB}=30\text{V}, I_E=0$		0.1	$\mu\text{A}$
Collector cut-off current	BC546	$I_{CEO}$	$V_{CE}=60\text{V}, I_B=0$		0.1	$\mu\text{A}$
	BC547		$V_{CE}=45\text{V}, I_B=0$		0.1	$\mu\text{A}$
	BC548		$V_{CE}=30\text{V}, I_B=0$		0.1	$\mu\text{A}$
Emitter cut-off current	$I_{EBO}$	$V_{EB}=5\text{V}, I_C=0$			0.1	$\mu\text{A}$
DC current gain	$h_{FE}^*$	$V_{CE}=5\text{V}, I_C=2\text{mA}$	110		800	
Collector-emitter saturation voltage	$V_{CE(sat)}$	$I_C=100\text{mA}, I_B=5\text{mA}$			0.3	V
Base-emitter saturation voltage	$V_{BE(sat)}$	$I_C=100\text{mA}, I_B=5\text{mA}$			1.1	V
Base-emitter voltage	$V_{BE}$	$V_{CE}=5\text{V}, I_C=2\text{mA}$	0.58		0.7	V
		$V_{CE}=5\text{V}, I_C=10\text{mA}$			0.75	V
Collector output capacitance	$C_{ob}$	$V_{CB}=10\text{V}, I_E=0, f=1\text{MHz}$			4.5	pF
Transition frequency	$f_T$	$V_{CE}=5\text{V}, I_C=10\text{mA}, f=100\text{MHz}$	150			MH

### CLASSIFICATION of $h_{FE}$

RANK	A	B	C
RANGE	110-220	200-450	420-800

## TO-92 Package Outline Dimensions

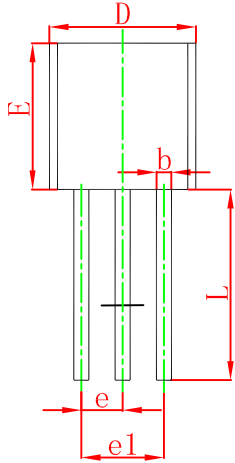
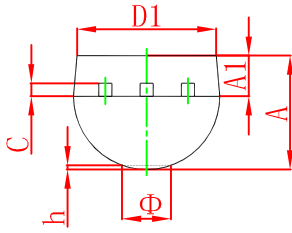

Symbol	Dimensions In Millimeters		Dimensions In Inches	
	Min	Max	Min	Max
A	3.300	3.700	0.130	0.146
A1	1.100	1.400	0.043	0.055
b	0.380	0.550	0.015	0.022
c	0.360	0.510	0.014	0.020
D	4.300	4.700	0.169	0.185
D1	3.430		0.135	
E	4.300	4.700	0.169	0.185
e	1.270 TYP		0.050 TYP	
e1	2.440	2.640	0.096	0.104
L	14.100	14.500	0.555	0.571
Φ		1.600		0.063
h	0.000	0.380	0.000	0.015

## TO-92 Suggested Pad Layout

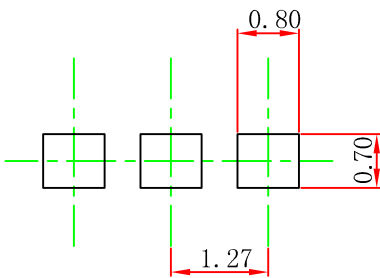

### Note:

1. Controlling dimension: in millimeters.
2. General tolerance:  $\pm 0.05$ mm.
3. The pad layout is for reference purposes only.

### NOTICE

JSCJ reserves the right to make modifications, enhancements, improvements, corrections or other changes without further notice to any product herein. JSCJ does not assume any liability arising out of the application or use of any product described herein.

TO-92 PACKAGE TAPING DIMENSION

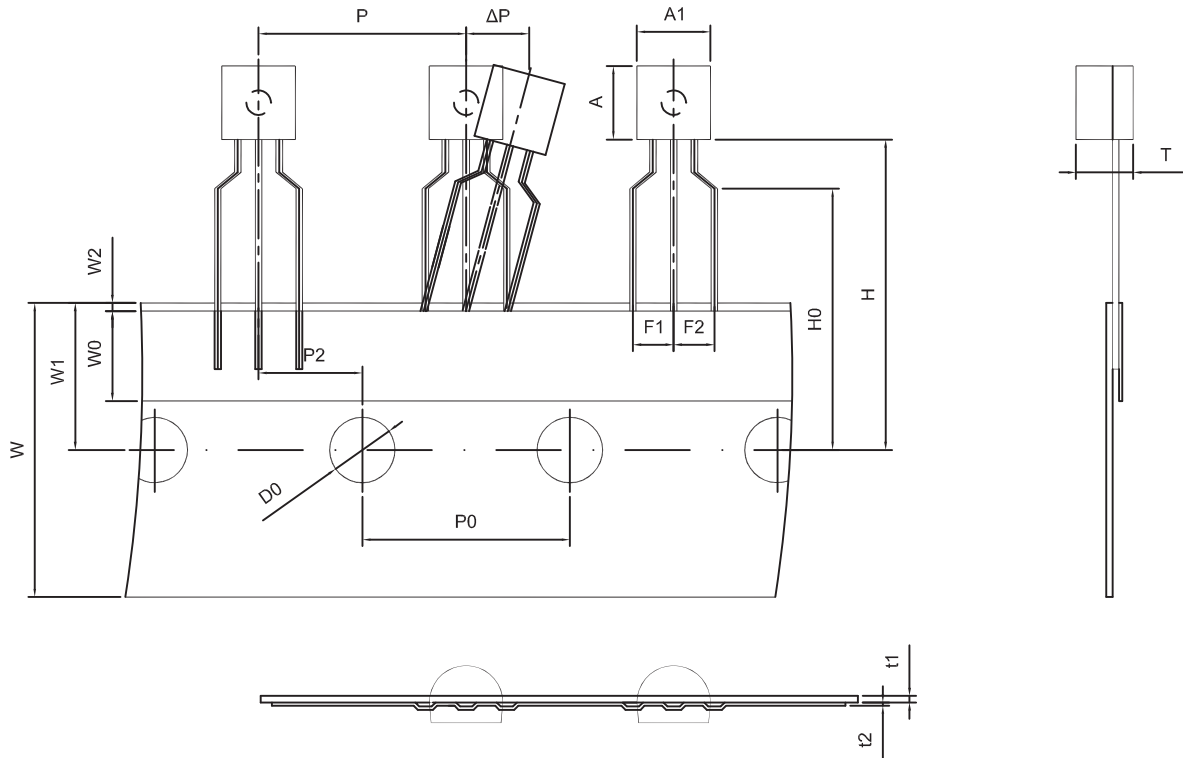

Dimensions are in millimeter								
A1	A	T	P	P0	P2	F1	F2	W
4.5	4.5	3.5	12.7	12.7	6.35	2.5	2.5	18.0
W0	W1	W2	H	H0	D0	t1	t2	ΔP
6.0	9.0	1.0 MAX.	19.0	16.0	4.0	0.4	0.2	0

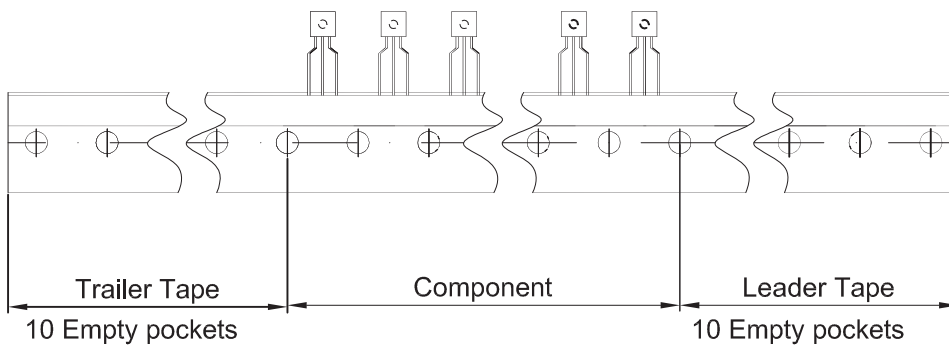

Package	Box	Box Size(mm)	Carton	Carton Size(mm)
TO-92	2000 pcs	333×162×43	20,000 pcs	350×340×250