

GENERAL DESCRIPTION

The LW59XX Series is a Sub- μ A power consumption, high accuracy, low drop-out voltage regulator with Chip Enable Pin, high ripple rejection and fast discharge function.

The current limiter's fold-back circuit operates as a short circuit protection as well as the output current limiter for the output pin.

Output voltage is selectable from 0.8V to 5.0V which fixed by laser trimming technologies, Step=100mV.

The LW59XX is available in SOT23, SOT23-3L, SOT23-5L and DFN1x1-4L packages.

FEATURES

- Ultra-Low Power Consumption: 0.65 μ A(Typ.)
- Operating Voltage Range: from 1.6V to 7.0V
- Output Voltage Range: from 0.8V to 5.0V
- Maximum Output Current: 400mA
- Output Accuracy: $\pm 1.5\%$
- Low Dropout Voltage: 640mV@400mA/3.3V
- Low Temperature Coefficient
- Current Limiting Protection
- Output Short-Circuit Protection
- Stable with 1 μ F Output Capacitor
- Fast Discharge Function
- Available in SOT23, SOT23-3L, SOT23-5L and DFN1x1-4L Packages

APPLICATIONS

- Battery-Powered Devices
- Portable Consumer Equipment
- Ultra Low Power Applications

TYPICAL APPLICATION CIRCUIT

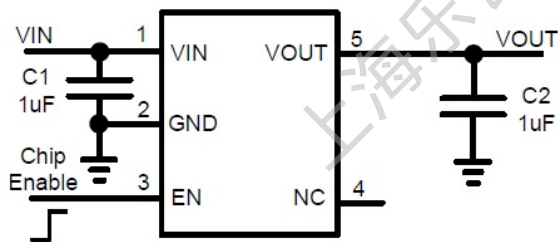

Note: EN must NOT be left floating.

PIN ASSIGNMENT

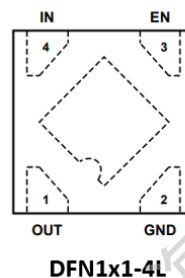
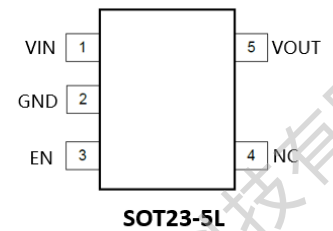
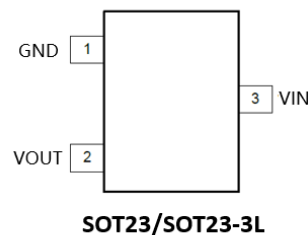

PIN DESCRIPTION:

PIN No			SYMBOL	DESCRIPTION
SOT23/ SOT23-3L	SOT23-5L	DFN1x1-4L		
3	1	4	VIN	Power Supply Input
1	2	2,E-PAD	GND	Ground
--	3	3	EN	Chip Enable
--	4	--	NC	Not Connected
2	5	1	VOUT	Output

MARK INFORMATION:

SOT23

XX: VOLTAGE

59XXYY

YY: DATE CODE

SOT23-3L/SOT23-5L

XX: VOLTAGE

LW59XX
YYYYY

YY: DATE CODE

DFN1x1-4L

X: VOLTAGE

59X

0.8V	0.9V	1.0V	1.2V	1.5V	1.8V	2.5V	2.8V	3.0V	3.3V	3.6V	4.2V	5.0V
A	R	B	C	D	G	H	J	L	M	P	S	T

ABSOLUTE MAXIMUM RATINGS (1):

(T_A =25°C, unless otherwise specified.)

SYMBOL	ITEM	RATING	UNIT	
V _{IN}	Supply Voltage	-0.3~8.0	V	
V _{EN}	EN Pin Voltage	-0.3~8.0	V	
V _{OUT}	V _{OUT} pin Voltage	-0.3~(V _{IN} +0.3)	V	
V _(ESD)	ESD Susceptibility, HBM ⁽²⁾	±4000	V	
PD	Maximum Power Dissipation	SOT23	285	mW
		SOT23-3L	400	
		SOT23-5L	450	
		DFN1x1-4L	350	
PTR	Package Thermal Resistance Θ_{JA}	SOT23	350	°C/W
		SOT23-3L	312	
		SOT23-5L	220	
		DFN1x1-4L	280	
T _J	Junction Temperature Range	-40~150	°C	
T _{STG}	Storage Temperature Range	-40~150	°C	
T _{SOLDER}	Lead Temperature (Soldering)	260°C, 10s		

Note:

1. Stresses beyond those listed under Absolute Maximum Ratings may cause permanent damage to the device. These are stress ratings only, and functional operation of the device at these or any other conditions beyond those indicated under Recommended Operating Conditions is not implied. Exposure to absolute-maximum-rated conditions for extended periods may affect device reliability

2. per ANSI/ESDA/JEDEC JS-001

RECOMMENDED OPERATING RANGE:

SYMBOL	ITEM	VALUE	UNIT
V _{IN}	V _{IN} Supply Voltage	1.6~7.0	V
V _{EN}	EN Pin Voltage	0~7.0	V
V _{OUT}	V _{OUT} Pin Voltage	0.8~5.0	V
I _{OUT}	Output Current	0~400	mA
T _J	Junction Temperature Range	-40~125	°C

ELECTRICAL CHARACTERISTICS:

($V_{IN}=V_{OUT}+1V$, $V_{OUT}=3.3V$, $C_{IN}=C_{OUT}=1\mu F$, $T_A=25^\circ C$, unless otherwise specified.)

Symbol	Parameter	Test Conditions	MIN	TYP	MAX	Units
V_{IN}	Input Voltage		1.6		7.0	V
V_{OUT}	Output Accuracy	$I_{OUT}=1mA$	-1.5		+1.5	%
I_{LIM}	Current Limit ⁽¹⁾	$V_{IN}=4.3V$, $V_{OUT}=3.3V$	410	530		mA
I_Q	Quiescent Current	$V_{IN}=V_{EN}=V_{OUT}+1V$, No Load		0.65	1.0	μA
I_{SHD}	Shutdown Current	$V_{IN}=7.0V$, $V_{EN}=0V$			0.1	μA
V_{DROP}	Dropout Voltage ⁽²⁾	$I_{OUT}=100mA$, $V_{OUT}=3.3V$		130		mV
		$I_{OUT}=200mA$, $V_{OUT}=3.3V$		280		
		$I_{OUT}=300mA$, $V_{OUT}=3.3V$		460		
		$I_{OUT}=400mA$, $V_{OUT}=3.3V$		640		
S_{LINE}	Line Regulation	$V_{IN}=V_{OUT}+1V$ to $7.0V$, $I_{OUT}=1mA$		0.15	0.3	%/V
S_{LOAD}	Load Regulation	$1mA \leq I_{OUT} \leq 400mA$		0.0035	0.006	%/mA
I_{SHORT}	Short Current	$V_{OUT}=0V$		90		mA
V_{ENH}	EN High Voltage	$V_{IN}=1.6V$ to $7.0V$, $I_{OUT}=1mA$	1.6			V
V_{ENL}	EN Low Voltage				0.5	V
T_{STR}	Startup Time	From V_{EN} 'L' \rightarrow 'H' to $95\%*V_{OUT}$, $C_{OUT}=1\mu F$, No Load		800		μs
$PSRR$	Power Supply Rejection Ratio	$C_{IN} = None$, $I_{OUT}=10mA$	$f=217Hz$		55	dB
			$f=1KHz$		45	
			$f=10KHz$		35	
T_{SD}	Thermal Shutdown	Temperature rising		150		$^\circ C$
ΔT_{SD}	TSD Hysteresis	Temperature falling		20		$^\circ C$
R_{DSCHG}	R_{ON} of Discharge MOSFET	$V_{IN}=V_{OUT}+1V$, $V_{EN}=0V$		250		Ω

NOTES:

1. Guaranteed by design
2. The dropout voltage is defined as $V_{IN} - V_{OUT}$, when $V_{OUT} = 95\%*V_{OUT(NOM)}$

SIMPLIFIED BLOCK DIAGRAM:

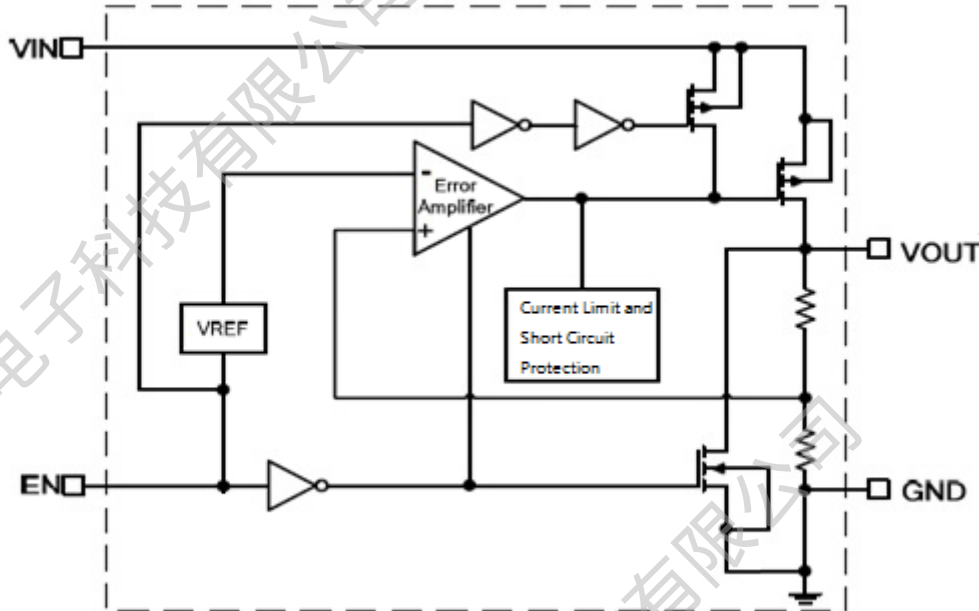

DETAIL OPERATION DESCRIPTION:

The LW59XX is a low power consumption low drop-out voltage regulator. It consists of a current limiter circuit, a driver transistor, a precision voltage reference and an error correction circuit, and is compatible with low ESR ceramic capacitors. The current limiter's fold-back circuit operates as a short circuit protection as well as the output current limiter.

Current Limiting and Short-Circuit Protection

The current limit circuitry prevents damage to the MOSFET switch and the hub downstream port but can deliver load current up to the current limit threshold through the switch. When a heavy load or short circuit is applied to an enabled switch, a large transient current may flow until the current limit circuitry responds. Once this current limit threshold is exceeded the device enters constant current mode until the thermal shutdown occurs or the fault is removed.

TYPICAL OPERATING CHARACTERISTICS:

(Tested under $T_A=25^\circ\text{C}$, unless otherwise specified)

1. V_{OUT} vs Temperature

($V_{IN}=4.3\text{V}$, $V_{OUT}=3.3\text{V}$, $I_{OUT}=10\text{mA}$)

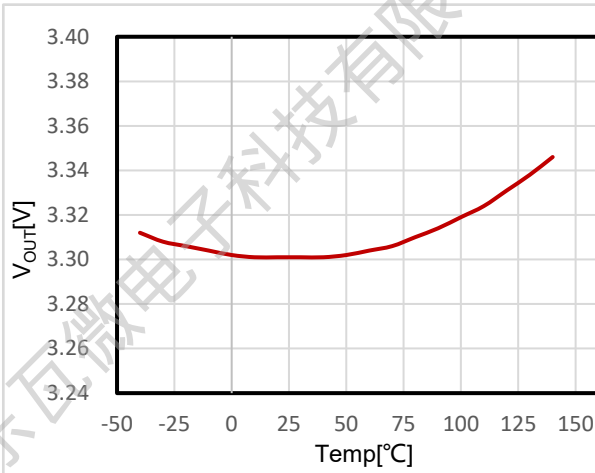

2. I_Q vs V_{IN}

($V_{OUT}=3.3\text{V}$, $I_{OUT}=0\text{mA}$)

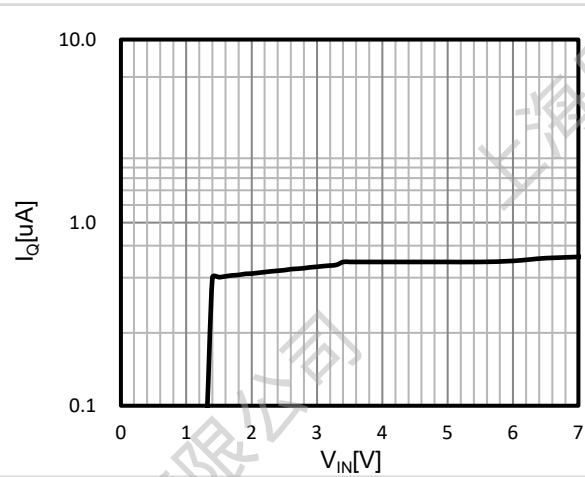

3. V_{OUT} vs I_{OUT}

($V_{IN}=4.3\text{V}$, $V_{OUT}=3.3\text{V}$, $I_{OUT}=0\rightarrow 400\text{mA}$)

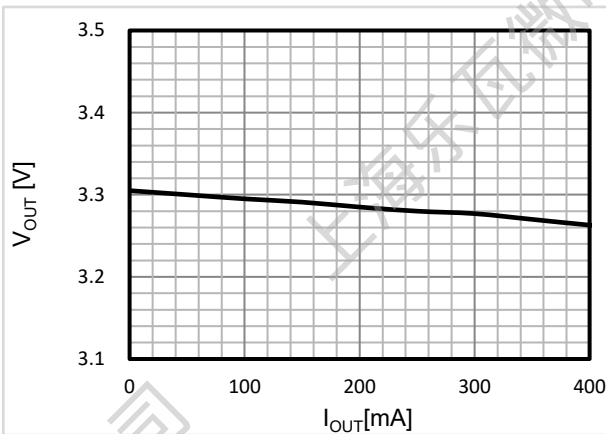

4. V_{OUT} vs V_{IN}

($V_{IN}=0\text{V}\rightarrow 7.0\text{V}$, $V_{OUT}=3.3\text{V}$, $I_{OUT}=1\text{mA}$)

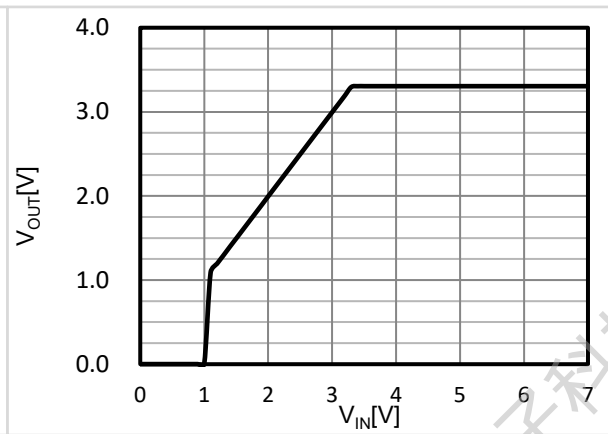

5. Dropout Voltage

($V_{OUT} = 95\% \times 3.3V$, $I_{OUT} = 0 \rightarrow 400mA$)

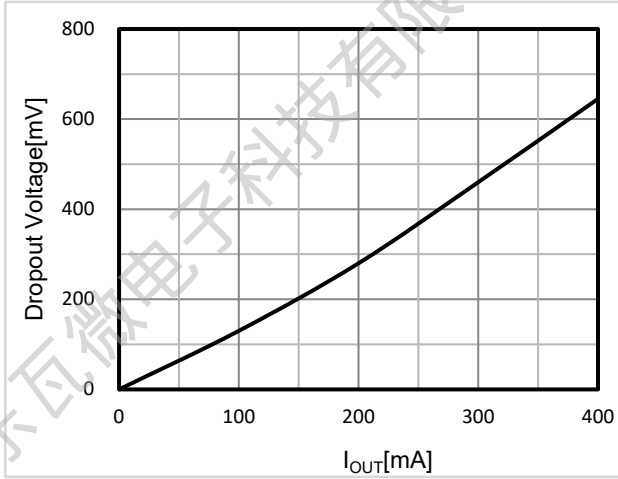

6. PSRR

($V_{IN} = 4.3V$, $V_{OUT} = 3.3V$, $V_{PP} = 1.0V$, $C_{IN} = \text{none}$, $C_{OUT} = 1\mu F$)

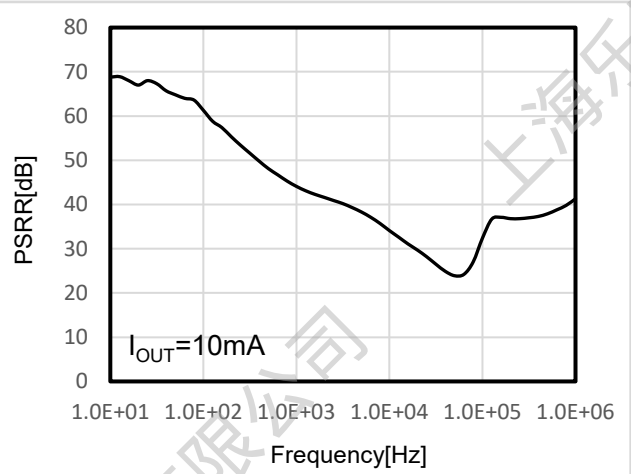

7. Load Transient Response

($V_{IN} = 4.3V$, $V_{OUT} = 3.3V$, $I_{OUT} = 1mA \rightarrow 400mA$)

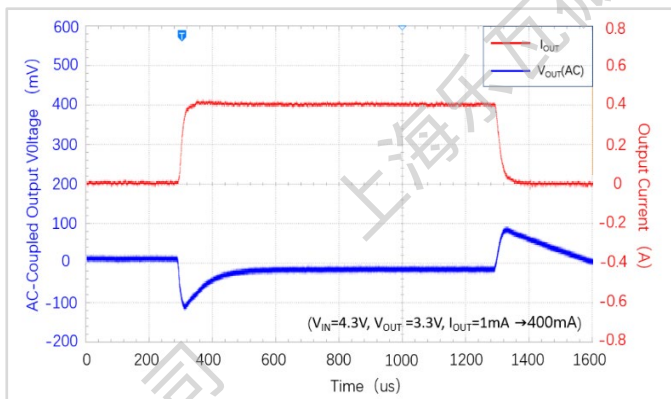

8. Start-Up

($V_{EN}=0V \rightarrow 2.8V, V_{OUT}=1.8V, \text{No load}$)

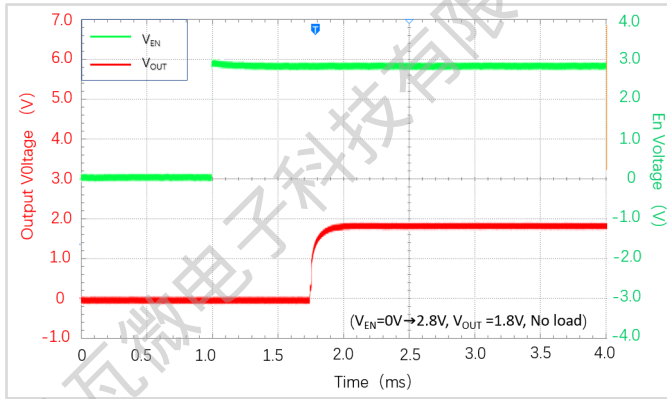

9. Start-Up

($V_{EN}=0V \rightarrow 2.8V, V_{OUT}=1.8V, R_{OUT}=4.5\Omega$)

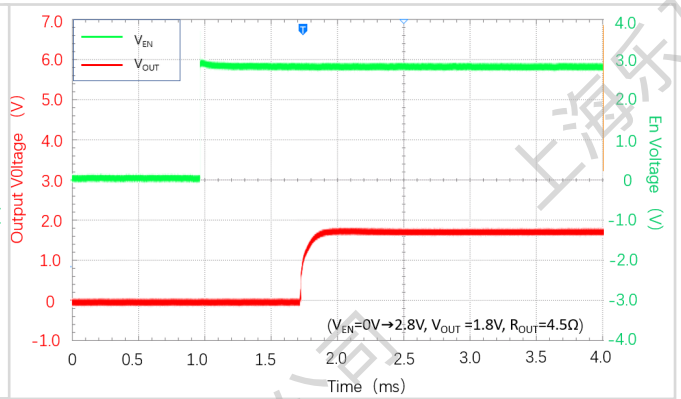

10. Start-Up

($V_{EN}=0V \rightarrow 4.3V, V_{OUT}=3.3V, \text{No load}$)

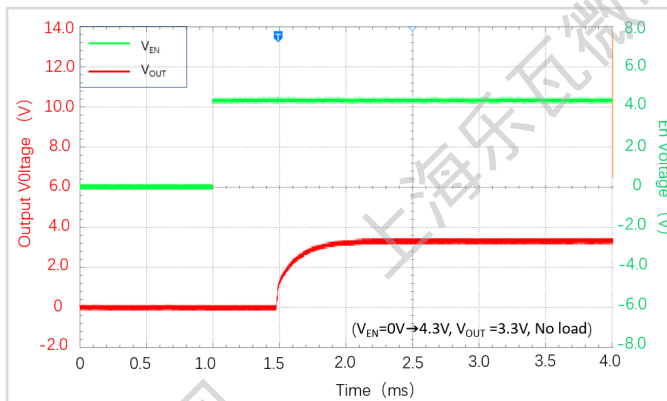

11. Start-Up

($V_{EN}=0V \rightarrow 4.3V, V_{OUT}=3.3V, R_{OUT}=8.25\Omega$)

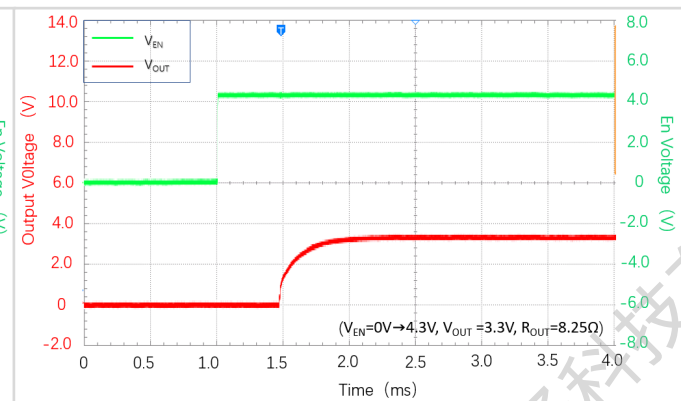

12. Shut-Down

($V_{EN}=2.8V \rightarrow 0V, V_{OUT}=1.8V, \text{No load}$)

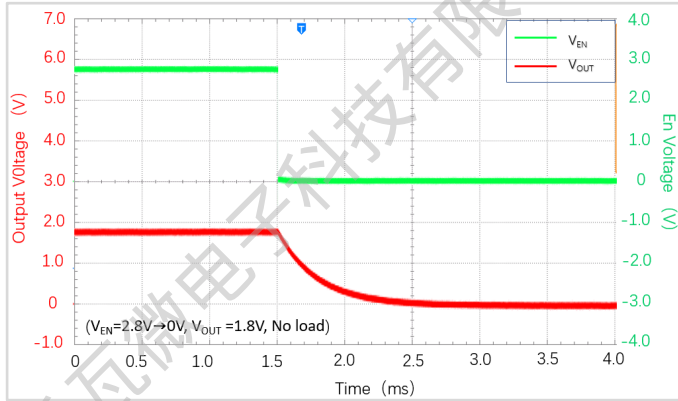

13. Shut-Down

($V_{EN}=2.8V \rightarrow 0V, V_{OUT}=1.8V, R_{OUT}=4.5\Omega$)

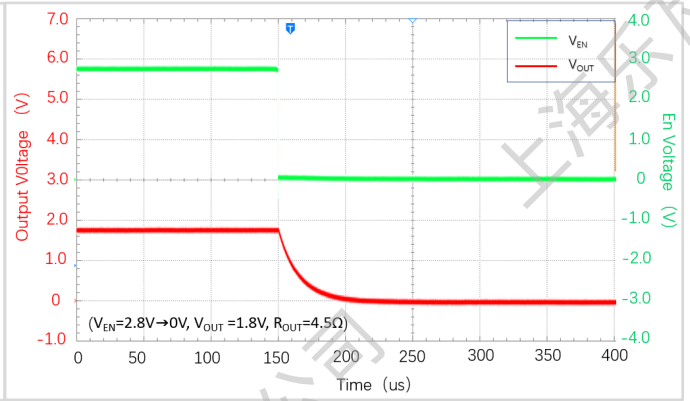

14. Shut-Down

($V_{EN}=4.3V \rightarrow 0V, V_{OUT}=3.3V, \text{No load}$)

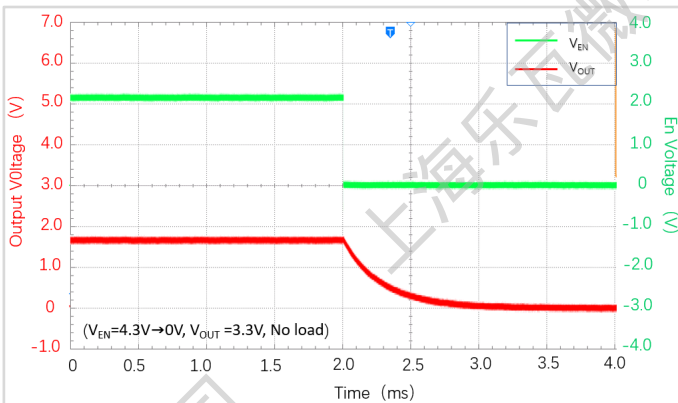

15. Shut-Down

($V_{EN}=4.3V \rightarrow 0V, V_{OUT}=3.3V, R_{OUT}=8.25\Omega$)

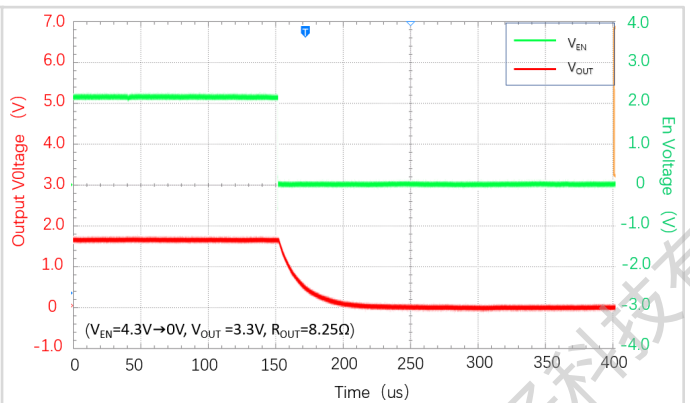

APPLICATION INFORMATION:**● Input Capacitor Selection**

Like any low-dropout regulator, the external capacitors used with the LW59XX Series must be carefully selected for regulator stability and performance. Using a capacitor whose value is $\geq 1\mu\text{F}$ on the LW59XX Series input and the amount of capacitance can be increased without limit. An at least $10\mu\text{F}$ input capacitor is needed if input ripple voltage $V_{pp} > 1\text{V}$. The input capacitor must be located a distance less than 0.5 inch from the input pin of the IC and returned to a clean analog ground. Any good quality ceramic or tantalum can be used for this capacitor. The capacitor with larger value and lower ESR (equivalent series resistance) provides better PSRR and line-transient response.

● Layout considerations

To improve ac performance such as PSRR, output noise, and transient response, it is recommended that the PCB be designed with separate ground planes for VIN and VOUT, with each ground plane connected only at the GND pin of the device.

● Output Capacitor Selection

The output capacitor must meet both requirements for minimum amount of capacitance and ESR in all LDOs application. The LW59XX Series is designed specifically to work with low ESR ceramic output capacitor in space-saving and performance consideration. Using a ceramic capacitor whose value is at least $1\mu\text{F}$ on the LW59XX Series output ensures stability. An appropriate output capacitor can reduce noise and improve load transient response and PSRR. The output capacitor should be located not more than 0.5 inch from the VOUT pin of the LW59XX Series and returned to a clean analog ground.

ORDER INFORMATION:

LW59①②③④⑤⑥

Designator	Item	Symbol	Description
①②	Output Voltage	10~50	e.g.2.8V→①=2,②=8
③④⑤⑥	Packages	N23C	SOT23
		N23D	SOT23-3L
		A23E	SOT23-5L
		N11E	DFN1x1-4L

Part #	Output Voltage	Package	Shipping
LW5910N23C	1.0V	SOT23	3000 Pcs/ Tape & Reel
LW5912N23C	1.2V		
LW5915N23C	1.5V		
LW5918N23C	1.8V		
LW5925N23C	2.5V		
LW5928N23C	2.8V		
LW5930N23C	3.0V		
LW5933N23C	3.3V		
LW5936N23C	3.6V		
LW5942N23C	4.2V		
LW5950N23C	5.0V		
LW5910N23D	1.0V	SOT23-3L	3000 Pcs/ Tape & Reel
LW5912N23D	1.2V		
LW5915N23D	1.5V		
LW5918N23D	1.8V		
LW5925N23D	2.5V		
LW5928N23D	2.8V		
LW5930N23D	3.0V		
LW5933N23D	3.3V		
LW5936N23D	3.6V		
LW5942N23D	4.2V		
LW5950N23D	5.0V		

Part #	Output Voltage	Package	Shipping
LW5910A23E	1.0V	SOT23-5L	3000 Pcs/ Tape & Reel
LW5912A23E	1.2V		
LW5915A23E	1.5V		
LW5918A23E	1.8V		
LW5925A23E	2.5V		
LW5928A23E	2.8V		
LW5930A23E	3.0V		
LW5933A23E	3.3V		
LW5936A23E	3.6V		
LW5942A23E	4.2V		
LW5950A23E	5.0V		
LW5910N11E	1.0V	DFN1x1-4L	10000 Pcs/ Tape & Reel
LW5912N11E	1.2V		
LW5915N11E	1.5V		
LW5918N11E	1.8V		
LW5925N11E	2.5V		
LW5928N11E	2.8V		
LW5930N11E	3.0V		
LW5933N11E	3.3V		
LW5936N11E	3.6V		
LW5942N11E	4.2V		
LW5950N11E	5.0V		

If customers have special output voltage requirements, please contact us.

PACKAGE OUTLINE:

SOT23 Package

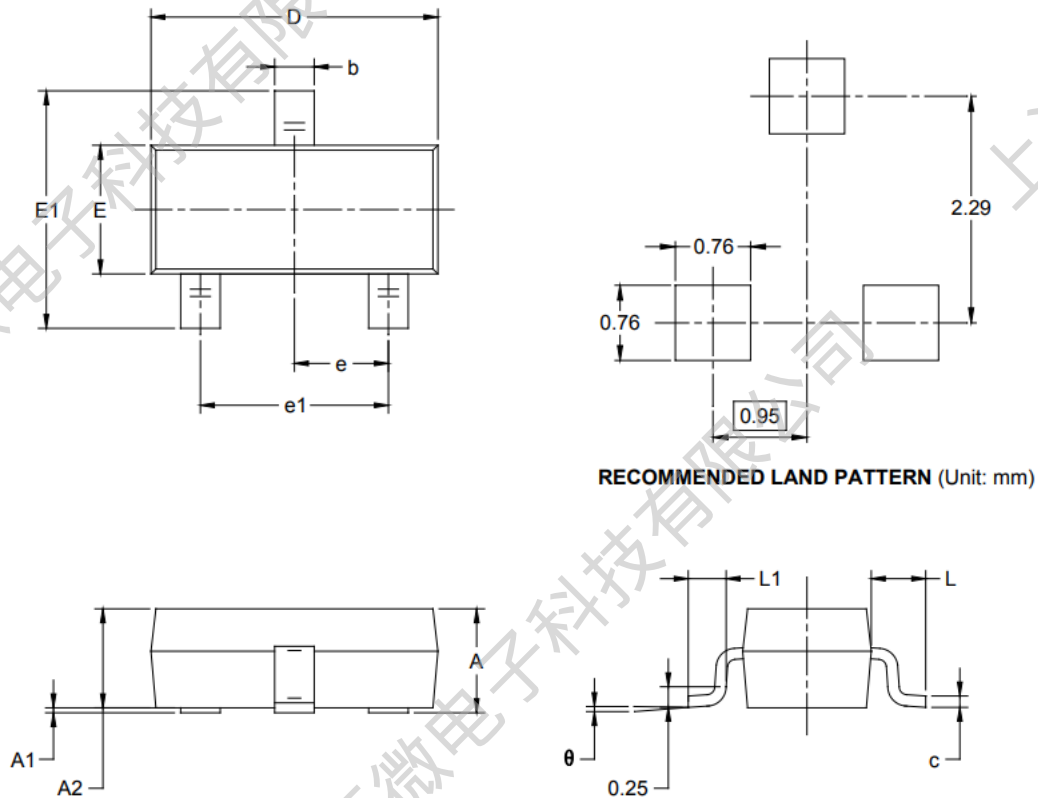

Symbol	Dimensions In Millimeters		Dimensions In Inches	
	MIN	MAX	MIN	MAX
A	0.900	1.150	0.035	0.045
A1	0.000	0.100	0.000	0.004
A2	0.900	1.050	0.035	0.041
b	0.300	0.500	0.012	0.020
c	0.080	0.150	0.003	0.006
D	2.800	3.000	0.110	0.118
E	1.200	1.400	0.047	0.055
E1	2.250	2.550	0.089	0.100
e	0.950 BSC		0.037 BSC	
e1	1.900 BSC		0.075 BSC	
L	0.550 REF		0.022 REF	
L1	0.300	0.500	0.012	0.020
θ	0°	8°	0°	8°

SOT23-3L Package

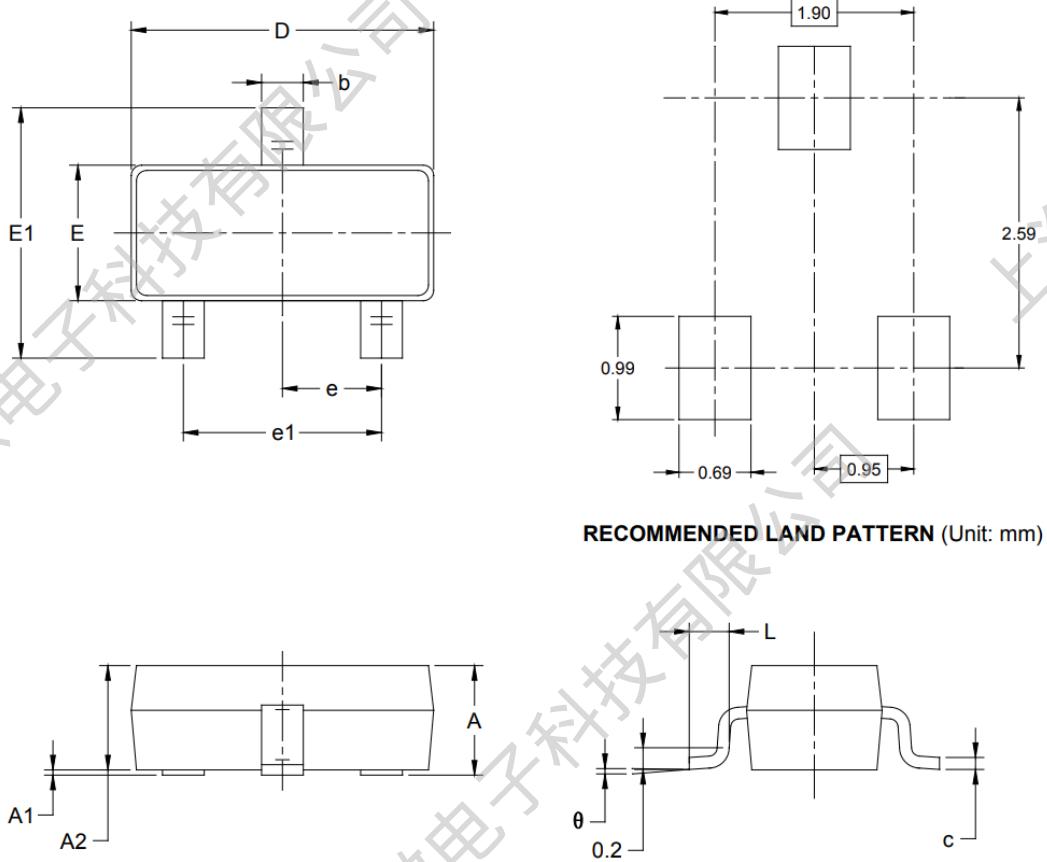

Symbol	Dimensions In Millimeters		Dimensions In Inches	
	MIN	MAX	MIN	MAX
A	1.050	1.250	0.041	0.049
A1	0.000	0.100	0.000	0.004
A2	1.050	1.150	0.041	0.045
b	0.300	0.500	0.012	0.020
c	0.100	0.200	0.004	0.008
D	2.820	3.020	0.111	0.119
E	1.500	1.700	0.059	0.067
E1	2.650	2.950	0.104	0.116
e	0.950 BSC		0.037 BSC	
e1	1.900 BSC		0.075 BSC	
L	0.300	0.600	0.012	0.024
θ	0°	8°	0°	8°

SOT23-5L Package

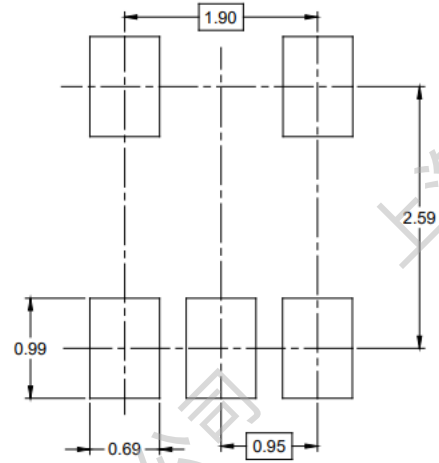
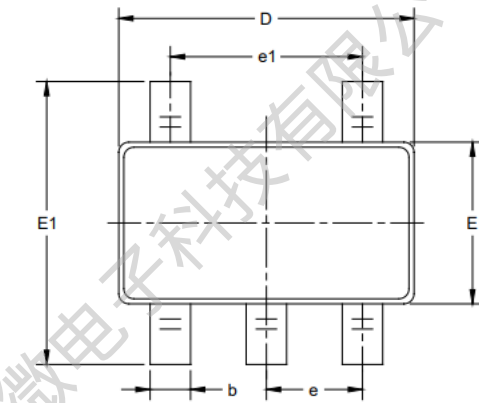

RECOMMENDED LAND PATTERN (Unit: mm)

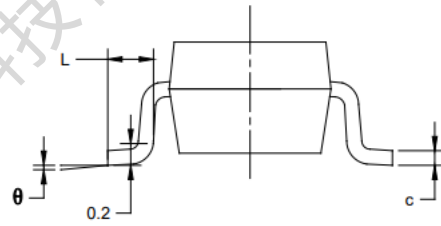
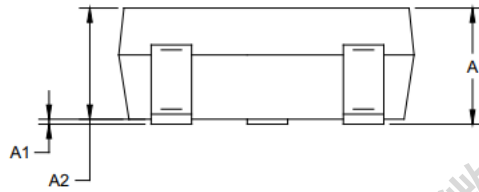

Symbol	Dimensions In Millimeters		Dimensions In Inches	
	MIN	MAX	MIN	MAX
A	1.050	1.250	0.041	0.049
A1	0.000	0.100	0.000	0.004
A2	1.050	1.150	0.041	0.045
b	0.300	0.500	0.012	0.020
c	0.100	0.200	0.004	0.008
D	2.820	3.020	0.111	0.119
E	1.500	1.700	0.059	0.067
E1	2.650	2.950	0.104	0.116
e	0.950 BSC		0.037 BSC	
e1	1.900 BSC		0.075 BSC	
L	0.300	0.600	0.012	0.024
θ	0°	8°	0°	8°

DFN1x1-4L Package

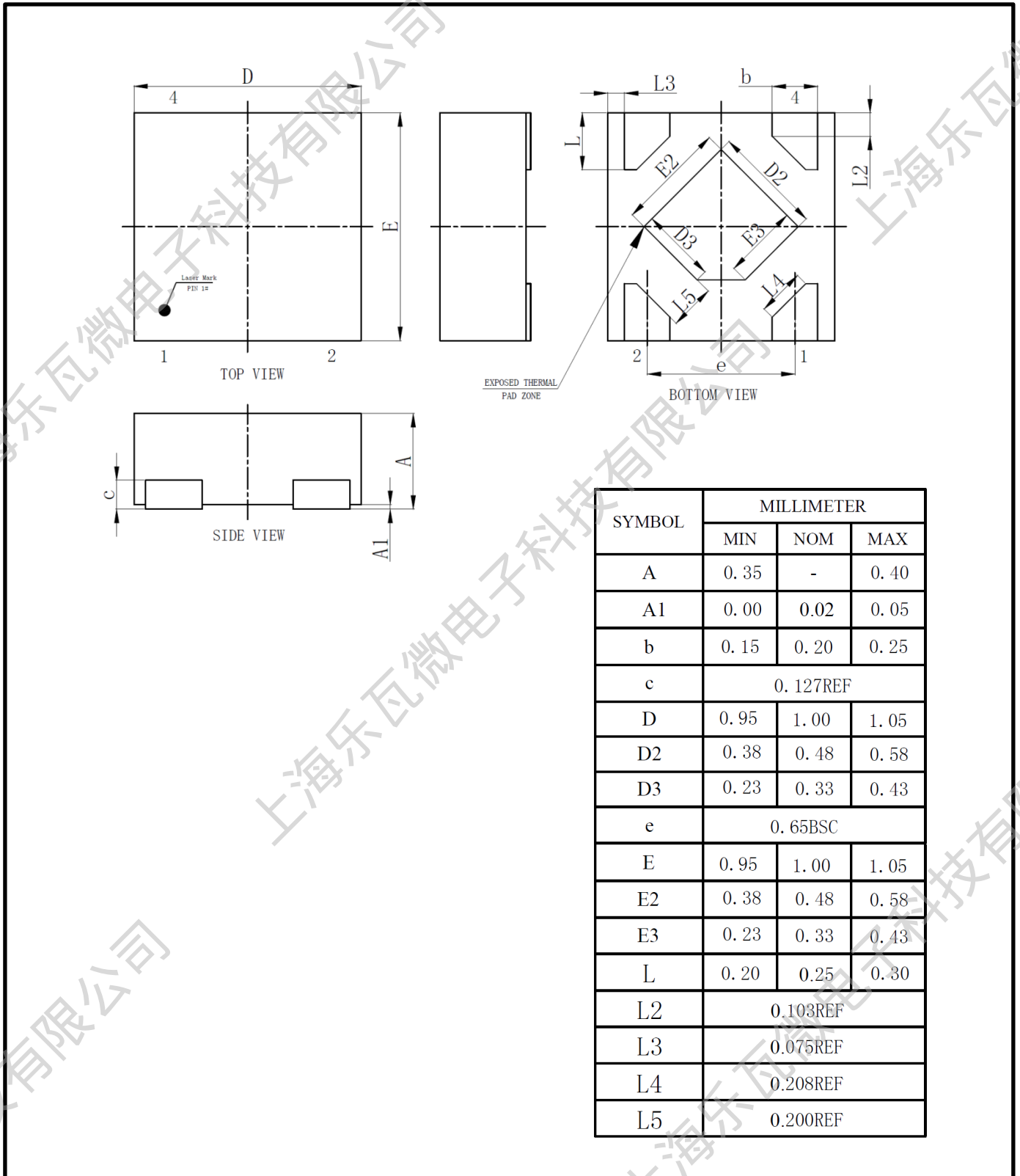

Revision History:

Revision	Date	Descriptions
Rev 1.0	Dec.2020	Initial Version
Rev 1.1	Apr.2021	Update Electrical Characteristics and Typical Operating Characteristics
Rev 1.2	May.2021	Update Typical Operating Characteristics Based on Mass Lot Data
Rev 1.3	Jan.2022	Redefine Order Information
Rev 1.4	Mar.2022	Update layout
Rev 1.5	Jun.2022	Adjust Typical Operating Characteristics 7-9
Rev 1.6	Aug.2022	Update Typical Operating Characteristics 10-15
Rev 1.7	Sep.2022	Adjust Order Information
Rev 1.8	Jun.2023	Update Typical Operating Characteristics

DISCLAIMER:

The information in this document is believed to be accurate and reliable. However, no responsibility is assumed by LW-Micro for its use. All operating parameters must be designed, validated and tested to ensure they meet the requirements of your application. LW-Micro reserves the right to make any specification and/or circuitry changes without prior notification. Before starting a brand-new project, please contact LW-Micro Sales to get the most recent relevant information.

Mailing Address: Room 301, Building 2, No.1690 CaiLun Road, China (Shanghai) Pilot Free Trade Zone
Shanghai Lewa Micro-electronics Technology Co., Ltd