

Specifications:

规格:

Voltage rating: 250V AC/DC
 额定电压: 250V AC/DC
 Current rating: 4A AC/DC
 额定电流: 4A AC/DC
 Withstanding voltage: 1500V AC/minute
 耐受电压: 1500V AC/分钟
 Temperature range: -40°C~+105°C
 温度范围: -40°C~+105°C
 Insulation resistance: 1000MΩ min
 绝缘电阻: 1000MΩ Min
 Contact resistance: 15mΩ Max
 接触电阻: 15mΩ Max

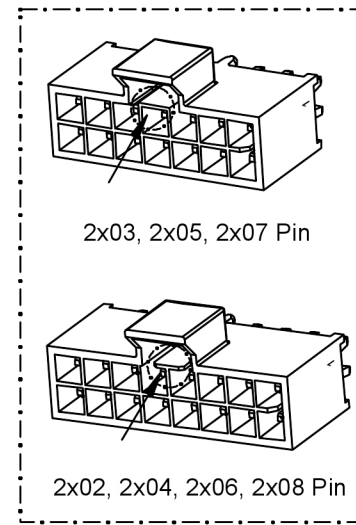
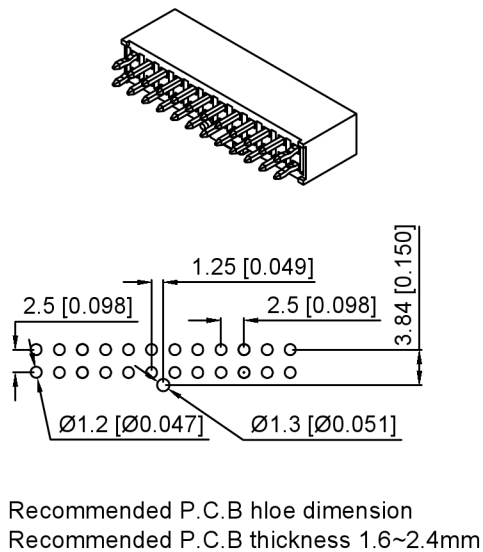
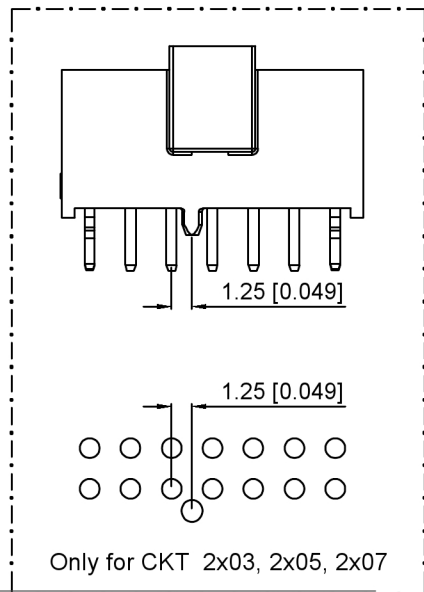

| | | | | | | |
|-------|---|---|------|---|----|----|
| X2513 | W | V | 2xXX | X | LP | SN |
| ① | ② | ③ | ④ | ⑤ | ⑥ | ⑦ |

- Series No
- Category: W-Wafer
- Welding Board Range: V-Stright 180°
- Row No. Pin No: 2xXX-2x02~2x08 Pin
- Special No: A: A Key (Black); B: B Key (Natural)
- Material: LP-LCP UL94V-0
- Plating: SN-Tin plated

| Circuit | DIM. A | DIM. B |
|-----------|----------------|-----------------|
| N(N=4~16) | 1.25 x N - 2.5 | 1.25 x N + 0.94 |

| X2513WW-2xXXA-LPSN | LCP | Copper Alloy | X2513H |
|--------------------|----------|---------------|----------------------|
| X2513WW-2xXXB-LPSN | | | |
| PART NO | Material | Material(Pin) | Suitable XKB Housing |

| | | | |
|------|--|-------------|--|
| DSND | | SCALE: N/A | MODEL TYPE: 2.5mm Crimp Style Connector |
| DWN | | VIEW: | PART NO.: X2513WW-2xXXX-LPSN |
| CHKD | | UNIT: mm/in | DWG NO.: X-X2513WW-2xXXX-LPSN |
| APPD | | SIZE: A4 | WEIGHT SHEET REVISION 1/1 A0 |

XKLB

XKB INDUSTRIAL PRECISION CO., LIMITED

广东星坤科技股份有限公司

| MARK | DESCRIPTION | DATE | REVISED | APPROVED |
|------|-------------|------|---------|----------|
| Δ* | | | | |
| Δ* | | | | |
| Δ* | | | | |

文件工程章

| REVISIONS | DATE | REVISED | APPROVED | UNSPECIFIED TOLERANCES |
|-----------|------|---------|----------|------------------------|
| | | | | |

www.helloxkb.com www.helloxkb.cn www.xk-dg.cn

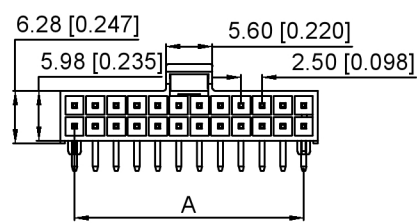
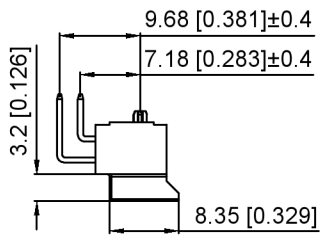
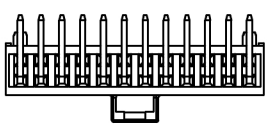
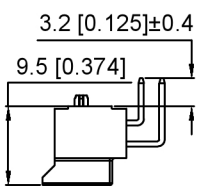
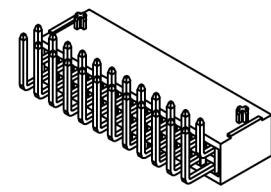
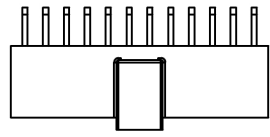
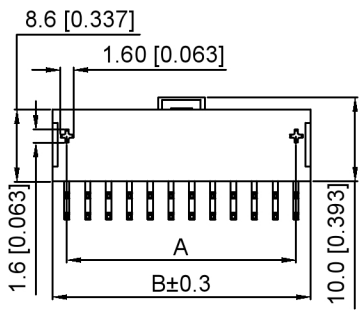

Specifications:

规格:
 Voltage rating:250V AC/DC
 额定电压: 250V AC/DC
 Current rating:5A AC/DC
 额定电流: 5A AC/DC
 Withstanding voltage:1500V AC/minute
 耐受电压: 1500V AC/分钟
 Temperature range:-25℃~+105℃
 温度范围: -25℃~+105℃
 Insulation resistance:1000MΩ min
 绝缘电阻: 1000MΩ Min
 Contact resistance:20mΩ Max
 接触电阻: 20mΩ Max

X2513 W R - 2xXX X - LP SN

① ② ③ ④ ⑤ ⑥ ⑦

- 1.Series No
- 2.Category:W-Wafer
- 3.Welding Board Range:R-Stright 90°
- 4.Row No.Pin No:2xXX-2x02~2x08 Pin
- 5.Special No: A:A Key ; B:B Key
- 6.Material:LP-LCP UL94V-0
- 7.Plating:SN-Tin plated

| | | | | |
|------------------------|------|------|------|------|
| | 2x02 | 2x03 | 2x04 | 2x05 |
| A Key Color:Black | | | | |
| B Key Color:Natural | | | | |
| | 2x06 | 2x07 | 2x08 | |
| A Key Color:Black | | | | |
| B Key Color:Natural | | | | |

A Key

B Key

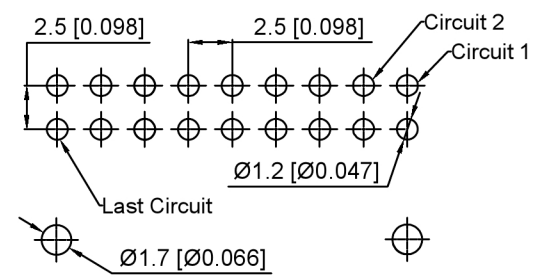

Recommended P.C.B hloe dimension
 Recommended P.C.B thickness 1.6~2.4mm

| Circuit | DIM. A | DIM. B |
|-----------|----------------|-----------------|
| N(N=4~16) | 1.25 x N - 2.5 | 1.25 x N + 0.94 |

| | | | |
|--------------------|----------|---------------|----------------------|
| X2513WR-2xXXA-LPSN | LCP | Copper Alloy | X2513H |
| X2513WR-2xXXB-LPSN | | | |
| PART NO | Material | Material(Pin) | Suitable XKB Housing |

| | | | |
|------|--|-------------|--|
| DSND | | SCALE: N/A | MODEL TYPE: 2.5mm Crimp Style Connector |
| DWN | | VIEW: | PART NO.: X2513WR-2xXXX-LPSN |
| CHKD | | UNIT: mm/in | DWG NO.: |
| APPD | | SIZE: A4 | X-X2513WR-2xXXX-LPSN |



广东星坤科技股份有限公司

| | |
|----|----|
| Δ姓 | 日期 |
| Δ数 | |
| ΔX | |

文件工程章

| MARK | DESCRIPTION | DATE | REVISED | APPROVED | UNSPECIFIED TOLERANCES |
|------|-------------|------|---------|----------|------------------------|
| | REVISIONS | | | | |
| | | | | | ANGLAR ±5° |
| | | | | | L ≤ 4 ±0.2 |
| | | | | | 4 < L ≤ 16 ±0.3 |
| | | | | | 16 < L ≤ 63 ±0.4 |
| | | | | | L > 63 ±0.5 |

XKB INDUSTRIAL PRECISION CO., LIMITED

| | | |
|--------|-------|----------|
| WEIGHT | SHEET | REVISION |
| | 1/1 | A0 |

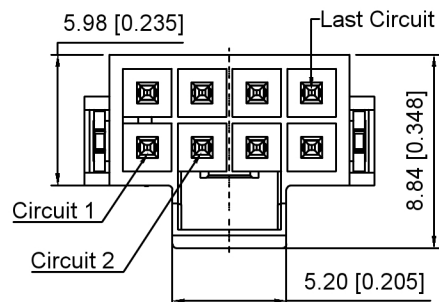
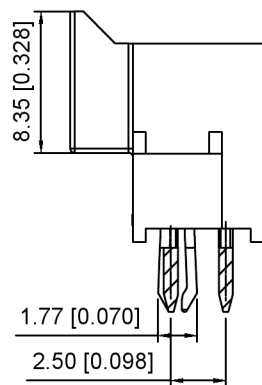
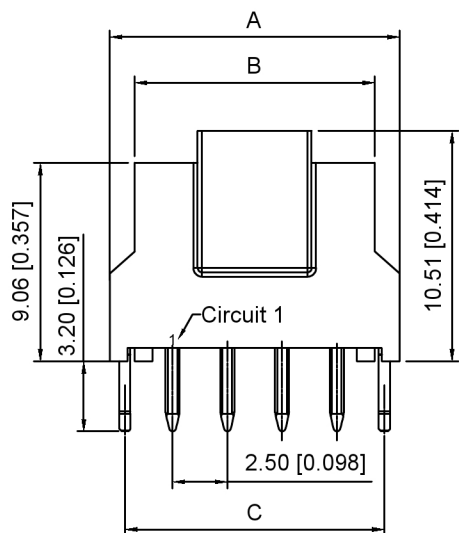

Specifications:
 规格:
Voltage rating:250V AC/DC
 额定电压: 250V AC/DC
Current rating:4A AC/DC
 额定电流: 4A AC/DC
Withstanding voltage:1500V AC/minute
 耐受电压: 1500V AC/分钟
Temperature range:-40°C~+105°C
 温度范围: -40°C~+105°C
Insulation resistance:1000MΩ min
 绝缘电阻: 1000MΩ Min
Contact resistance:15mΩ Max
 接触电阻: 15mΩ Max

X2513 W V - 2xXX L X - LP SN
 ① ② ③ ④ ⑤ ⑥ ⑦ ⑧

| | | | | |
|---------------|----------|----------|----------|----------|
| | 2x02 Pin | 2x03 Pin | 2x04 Pin | 2x05 Pin |
| A Key BLACK | | | | |
| B Key NATURAL | | | | |
| | 2x06 Pin | 2x07 Pin | 2x08 Pin | |
| A Key BLACK | | | | |
| B Key NATURAL | | | | |

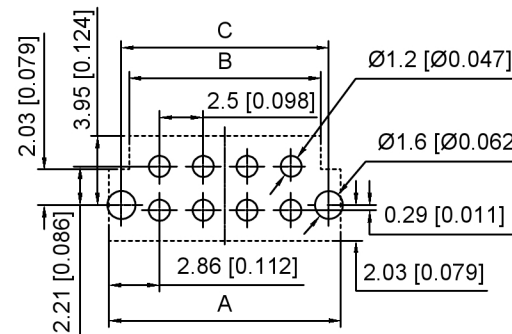

Recommended PCB Layout(Connector SIDE VIEW)
 Thickness=1.6mm ~2.4mm Tolerance:±0.05

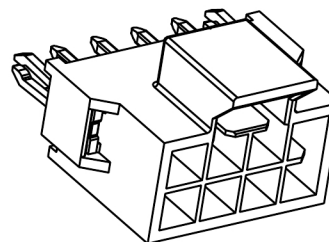

- Series No
- Category:W-Wafer
- Welding Board Range:V-Stright 180°
- Row No.Pin No:2xXX-2x02~2x12 Pin
- Special No:L-There are fixed card slots on both sides
- Type: A-A Key only for Black
B-B Key only for Natural color
- Material:LP-LCP UL94V-0
- Plating:SN-Tin plated
V01-Gold Flash

| PART NO | DIM.A | DIM.B | DIM.C |
|---------|-------|-------|-------|
| 2x02 | 8.22 | 5.95 | 6.84 |
| 2x03 | 10.72 | 8.44 | 9.34 |
| 2x04 | 13.22 | 10.94 | 11.84 |
| 2x05 | 15.72 | 13.44 | 14.34 |
| 2x06 | 18.22 | 15.94 | 16.84 |
| 2x07 | 20.72 | 18.44 | 19.34 |
| 2x08 | 23.22 | 20.94 | 21.84 |
| 2x12 | 25.22 | 22.94 | 23.84 |

| | | | |
|---------------------|----------|---------------|-----------------------|
| X2513WV-2xXXLA-LPSN | LCP | Copper Alloy | X2513H |
| X2513WV-2xXXLB-LPSN | | | |
| PART NO | Material | Material(Pin) | Suitable XK B Housing |

| | | | |
|------|--|-------------|--|
| DSND | | SCALE: N/A | MODEL TYPE: 2.5mm Crimp Style Connector |
| DWN | | VIEW: | PART NO.: X2513WV-2xXXLX-LPSN |
| CHKD | | UNIT: mm/in | DWG NO.: X-X2513WV-2xXXLX-LPSN |
| APPD | | SIZE: A4 | WEIGHT SHEET REVISION 1/1 A0 |

| | |
|------------------------|------|
| ANGLAR | ±5° |
| L ≤ 4 | ±0.2 |
| 4 < L ≤ 16 | ±0.3 |
| 16 < L ≤ 63 | ±0.4 |
| L > 63 | ±0.5 |
| UNSPECIFIED TOLERANCES | |



XKB INDUSTRIAL PRECISION CO., LIMITED

广东星坤科技股份有限公司

日期

文件工程章

| MARK | DESCRIPTION | DATE | REVISED | APPROVED |
|-----------|-------------|------|---------|----------|
| REVISIONS | | | | |

www.helloxkb.com www.helloxkb.cn www.xk-dg.cn

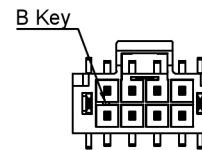
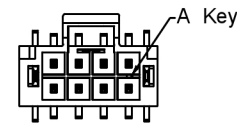
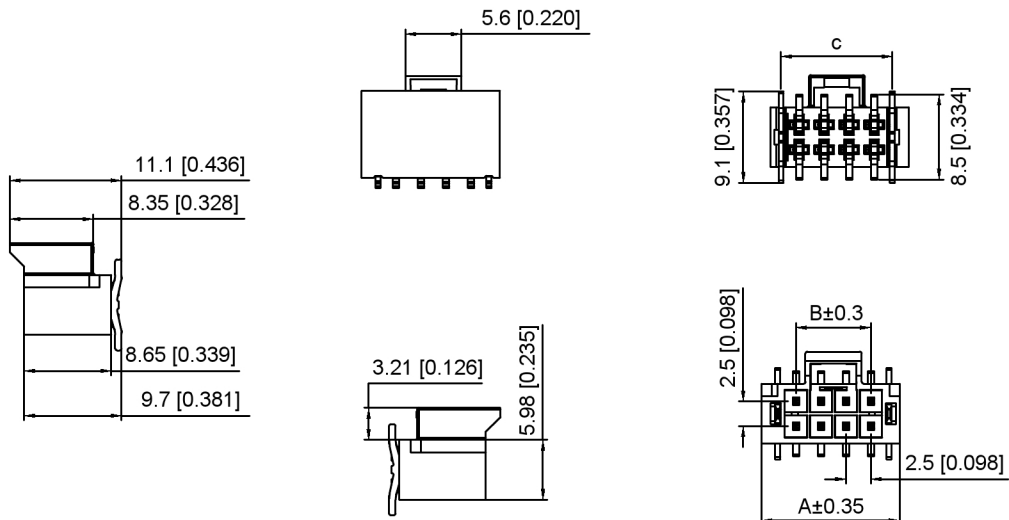

Specifications:
 规格:
 Voltage rating:250V AC/DC
 额定电压: 250V AC/DC
 Current rating:4A AC/DC
 额定电流: 4A AC/DC
 Withstanding voltage:1500V AC/minute
 耐受电压: 1500V AC/分钟
 Temperature range:-40℃~+105℃
 温度范围: -40℃~+105℃
 Insulation resistance:1000MΩ min
 绝缘电阻: 1000MΩ Min
 Contact resistance:15mΩ Max
 接触电阻: 15mΩ Max

X2513 W V S - 2xXX L X - LP SN
 ① ② ③ ④ ⑤ ⑥ ⑦ ⑧ ⑨

- Series No
- Category:W-Wafer
- Welding Board Range:V-Stright 180°
- Welding Way:S-SMT
- Row No.Pin No:2xXX-2x02~2x12 Pin
- Special No:L-There are fixed card slots on both sides
- Type: A-A Key only for Black
B-B Key only for Natural color
- Material:LP-LCP UL94V-0
- Plating:SN-Tin plated
V01-Gold Flash

| | | | | |
|---------------|----------|----------|----------|----------|
| | 2x02 Pin | 2x03 Pin | 2x04 Pin | 2x05 Pin |
| A Key BLACK | | | | |
| B Key NATURAL | | | | |
| | 2x06 Pin | 2x07 Pin | 2x08 Pin | |
| A Key BLACK | | | | |
| B Key NATURAL | | | | |

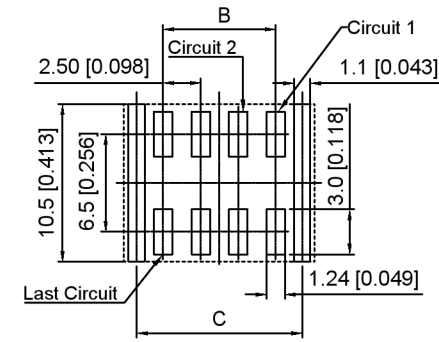

Recommended PCB Layout(Connector SIDE VIEW)
 Thickness=1.6mm Min.Tolerance:±0.05

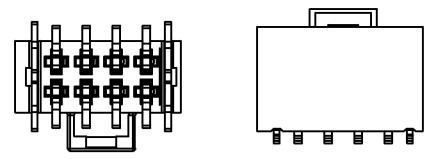

| PART NO | DIM.A | DIM.B | DIM.C |
|---------|-------|-------|-------|
| 2x02 | 8.83 | 2.50 | 6.11 |
| 2x03 | 11.33 | 5.00 | 8.61 |
| 2x04 | 13.83 | 7.50 | 11.11 |
| 2x05 | 16.33 | 10.00 | 13.61 |
| 2x06 | 18.83 | 12.50 | 16.11 |
| 2x07 | 21.33 | 15.00 | 18.61 |
| 2x08 | 23.83 | 17.50 | 21.11 |
| 2x12 | 25.83 | 19.50 | 23.11 |

| | | | |
|----------------------|----------|---------------|----------------------|
| X2513WVS-2xXXLA-LPSN | LCP | Copper Alloy | X2513H |
| X2513WVS-2xXXLB-LPSN | | | |
| PART NO | Material | Material(Pin) | Suitable XKB Housing |

广东星坤科技股份有限公司

| | |
|------------------------|------|
| ANGLAR | ±5° |
| L ≤ 4 | ±0.2 |
| 4 < L ≤ 16 | ±0.3 |
| 16 < L ≤ 63 | ±0.4 |
| L > 63 | ±0.5 |
| UNSPECIFIED TOLERANCES | |



| | | |
|---------------------------------------|-------------|--|
| DSND | SCALE: N/A | MODEL TYPE: 2.5mm Crimp Style Connector |
| DWN | VIEW: | PART NO.: X2513WVS-2xXXLX-LPSN |
| CHKD | UNIT: mm/in | DWG NO.: X-X2513WVS-2xXXLX-LPSN |
| APPD | SIZE: A4 | WEIGHT SHEET REVISION |
| KXB INDUSTRIAL PRECISION CO., LIMITED | | 1/1 A0 |

文件工程章

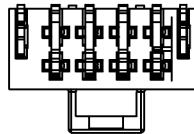
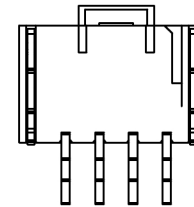
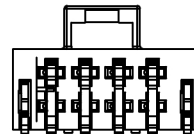
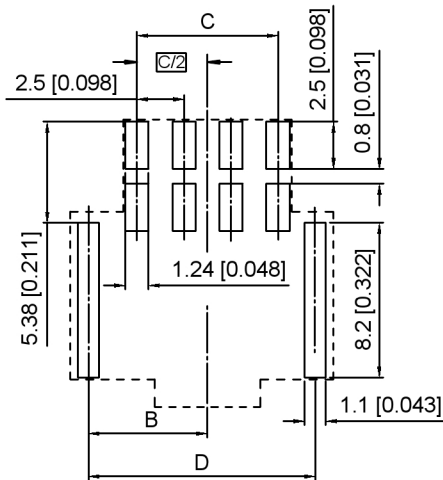
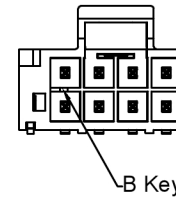
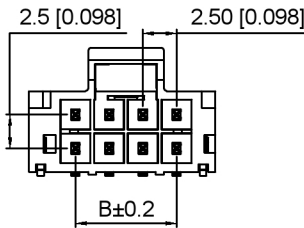
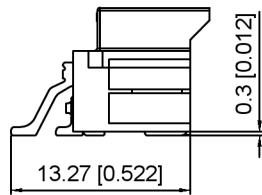
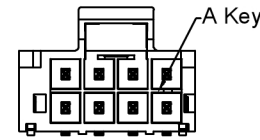
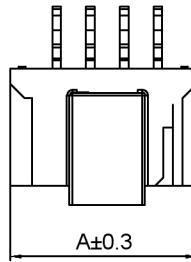
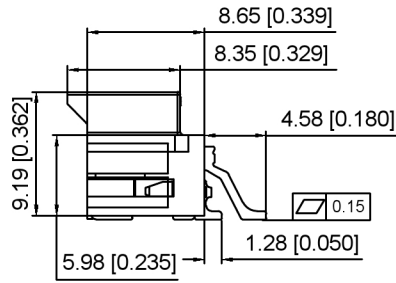

Specifications:

规格:
 Voltage rating:250V AC/DC
 额定电压: 250V AC/DC
 Current rating:4A AC/DC
 额定电流: 4A AC/DC
 Withstanding voltage:1500V AC/minute
 耐受电压: 1500V AC/分钟
 Temperature range:-40℃~+105℃
 温度范围: -40℃~+105℃
 Insulation resistance:1000MΩ min
 绝缘电阻: 1000MΩ Min
 Contact resistance:15mΩ Max
 接触电阻: 15mΩ Max

| | | | | | | | | |
|-------|---|---|---|--------|---|---|----|----|
| X2513 | W | R | S | - 2xXX | L | X | LP | SN |
| ① | ② | ③ | ④ | ⑤ | ⑥ | ⑦ | ⑧ | ⑨ |

- 1.Series No
- 2.Category:W-Wafer
- 3.Welding Board Range:R-Stright 90°
- 4.Welding Way:S-SMT
- 5.Row No.Pin No:2xXX-2x02~2x08 Pin
- 6.Special No:L-There are fixed card slots on both sides
- 7.Type: A-A Key only for Black
B-B Key only for Natural ccolor
- 8.Material:LP-LCP UL94V-0
- 9.Plating:SN-Tin plated
V01-Gold Flash

| PART NO | DIM.A | DIM.B | DIM.C | DIM.D |
|---------|-------|-------|-------|-------|
| 2x02 | 8.74 | 3.82 | 2.50 | 7.04 |
| 2x03 | 11.24 | 5.07 | 5.00 | 9.54 |
| 2x04 | 13.74 | 6.32 | 7.50 | 12.04 |
| 2x05 | 16.24 | 7.57 | 10.00 | 14.54 |
| 2x06 | 18.74 | 8.82 | 12.50 | 17.04 |
| 2x07 | 21.24 | 10.07 | 15.00 | 19.54 |
| 2x08 | 23.74 | 11.32 | 17.50 | 22.04 |

Recommended PCB Layout(Connector SIDE VIEW)
 Thickness=1.6mm Min.Tolerance:±0.05

| | | | |
|----------------------|----------|---------------|----------------------|
| X2513WRS-2xXXLA-LPSN | LCP | Copper Alloy | X2513H |
| X2513WRS-2xXXLB-LPSN | | | |
| PART NO | Material | Material(Pin) | Suitable XKB Housing |

| | | |
|------|-------------|--|
| DSND | SCALE: N/A | MODEL TYPE: 2.5mm Crimp Style Connector |
| DWN | VIEW: | PART NO.: X2513WRS-2xXXLX-LPSN |
| CHKD | UNIT: mm/in | DWG NO.: |
| APPD | SIZE: A4 | X-X2513WRS-2xXXLX-LPSN |



XKB INDUSTRIAL PRECISION CO.,LIMITED

| | | |
|--------|-------|----------|
| WEIGHT | SHEET | REVISION |
| | 1/1 | A0 |

| | |
|-------------|------|
| ANGLAR | ±5° |
| L ≤ 4 | ±0.2 |
| 4 < L ≤ 16 | ±0.3 |
| 16 < L ≤ 63 | ±0.4 |
| L > 63 | ±0.5 |

UNSPECIFIED TOLERANCES

广东星坤科技股份有限公司

| | |
|-------------|-------|
| DATE | 日期 |
| DESCRIPTION | 文件工程章 |

文件工程章

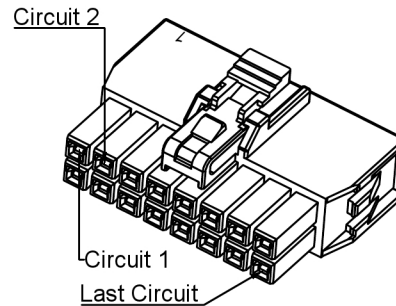
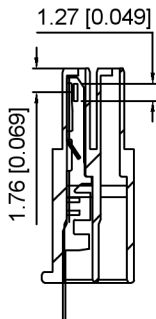
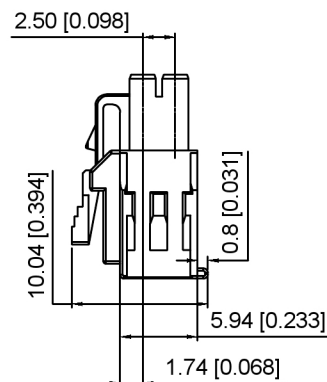
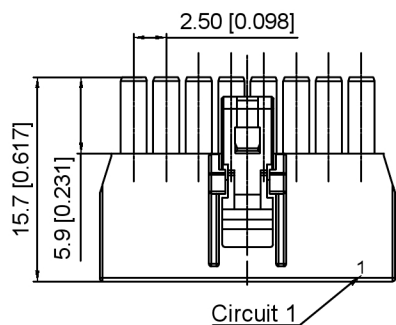

Specifications:

规格:
 Voltage rating: 250V AC/DC
 额定电压: 250V AC/DC
 Current rating: 4A AC/DC
 额定电流: 4A AC/DC
 Withstanding voltage: 1500V AC/minute
 耐受电压: 1500V AC/分钟
 Temperature range: -40°C~+105°C
 温度范围: -40°C~+105°C
 Insulation resistance: 1000MΩ min
 绝缘电阻: 1000MΩ Min
 Contact resistance: 30mΩ Max
 接触电阻: 30mΩ Max

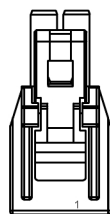
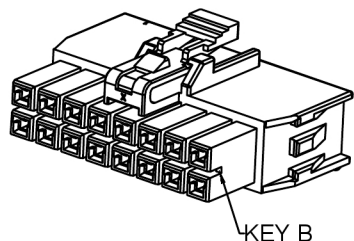
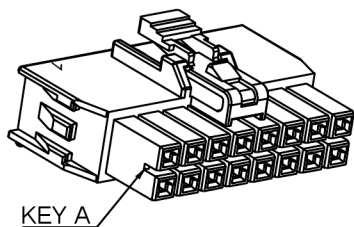
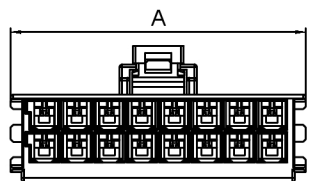

2x02 Pin

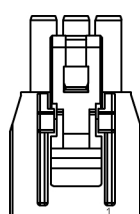

2x03 Pin

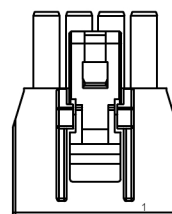

2x04 Pin

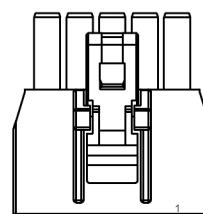

2x05 Pin

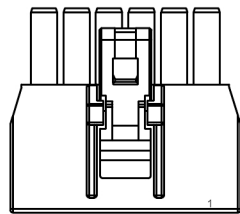

2x06 Pin

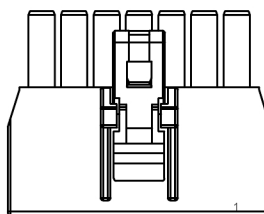

2x07 Pin

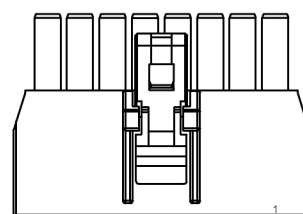

2x08 Pin

X2513 H - 2xXX X - 46
 ① ② ③ ④ ⑤

1. Series No
2. Category: H-HSG
3. Row No. Pin No: 2xXX-2x02~2x12 Pin
4. Special No: A: Key A (Black)
B: Key B (Natural)
5. Material: 46-Nylon 46+30%G.F UL94V-0

| Poles | Dimensions(mm) |
|-------|----------------|
| | A |
| 2x02 | 7.70 |
| 2x03 | 10.20 |
| 2x04 | 12.70 |
| 2x05 | 15.20 |
| 2x06 | 17.70 |
| 2x07 | 20.20 |
| 2x08 | 22.70 |
| 2x12 | 32.70 |

| | | | |
|-----------------|--------------------|-----------------------|--------------------------|
| X2513H-2xXXA-46 | Nylon 46+30%G.F | X2513W | X2513T |
| X2513H-2xXXB-46 | | | |
| PART NO | Material | Suitable XKB Wafer | Suitable XKB Terminal |

| | | |
|------|-------------|--|
| DSND | SCALE: N/A | MODEL TYPE: 2.5mm Crimp Style Connector |
| DWN | VIEW: | PART NO.: X2513H-2xXXX-46 |
| CHKD | UNIT: mm/in | DWG NO.: X-X2513H-2xXXX-46 |
| APPD | SIZE: A4 | |



XKB INDUSTRIAL PRECISION CO., LIMITED

| | | |
|--------|-------|----------|
| WEIGHT | SHEET | REVISION |
| | 1/1 | A0 |

广东星坤科技股份有限公司

| | |
|----|----|
| Δ建 | 日期 |
| Δ改 | 日期 |
| ΔX | |

文件工程章

| MARK | DESCRIPTION | DATE | REVISED | APPROVED | ANGLAR | ±5° |
|------|-------------|------|---------|----------|-------------|------|
| | | | | | L ≤ 4 | ±0.2 |
| | | | | | 4 < L ≤ 16 | ±0.3 |
| | | | | | 16 < L ≤ 63 | ±0.4 |
| | | | | | L > 63 | ±0.5 |

UNSPECIFIED TOLERANCES

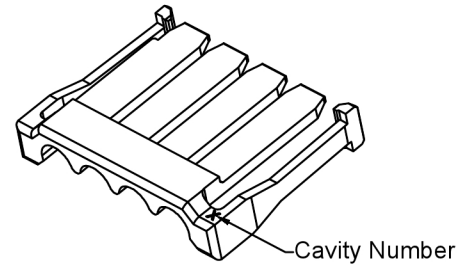
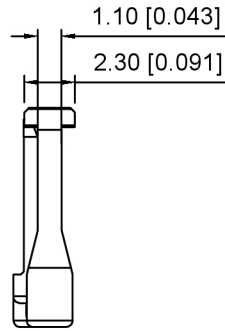
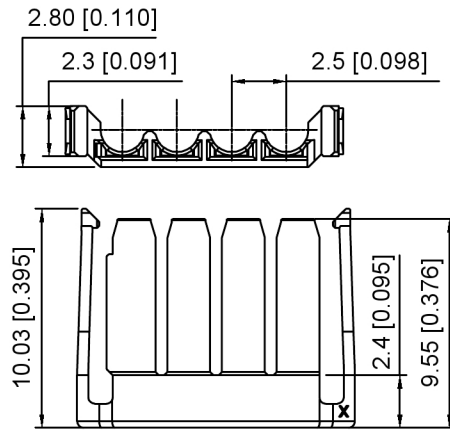

Specifications:
 规格:
 Voltage rating:250V AC/DC
 额定电压: 250V AC/DC
 Current rating:3A AC/DC
 额定电流: 3A AC/DC
 Withstanding voltage:1500V AC/minute
 耐受电压: 1500V AC/分钟
 Temperature range:-40°C+105°C
 温度范围: -40°C+105°C
 Insulation resistance:1000MΩ min
 绝缘电阻: 1000MΩ Min
 Contact resistance:30mΩ Max
 接触电阻: 30mΩ Max

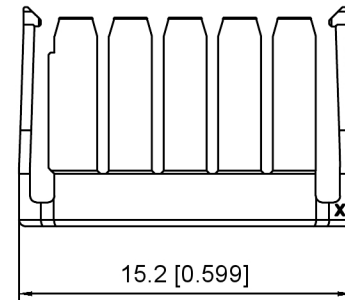
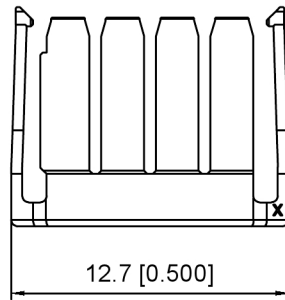
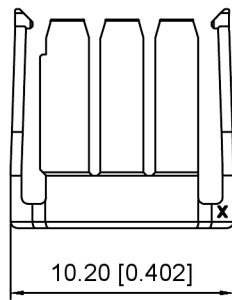
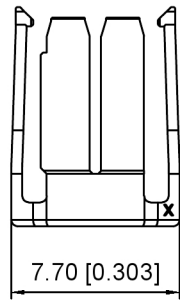

X2513 H L - XX - N0 X
 ① ② ③ ④ ⑤ ⑥

- 1.Series No
- 2.Category:H-HSG
- 3.Category:L-jointing clamp
- 4.Row No.Pin No:XX-02~08 Pin
- 5.Material:N0-Nylon 66 UL94V-0
- 6.Color:Blank-Natural ; BK-Black

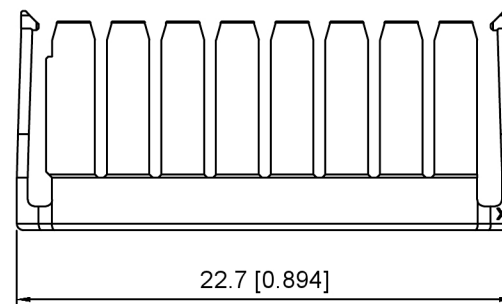
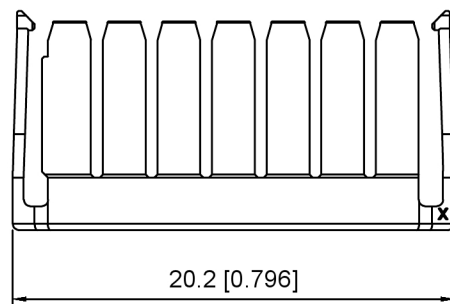
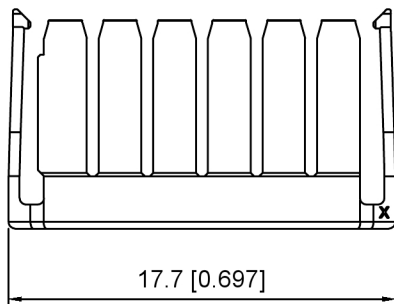

| | | | |
|---------------|----------|----------------------|-----------------------|
| X2513HL-XX-N0 | Nylon 66 | X2513H | X2513T |
| PART NO | Material | Suitable XKB Housing | Suitable XKB Terminal |

广东星坤科技股份有限公司

文件工程章

| | |
|------------------------|------|
| ANGLAR | ±5° |
| L ≤ 4 | ±0.2 |
| 4 < L ≤ 16 | ±0.3 |
| 16 < L ≤ 63 | ±0.4 |
| L > 63 | ±0.5 |
| UNSPECIFIED TOLERANCES | |



| | | |
|------|-------------|--|
| DSND | SCALE: N/A | MODEL TYPE: 2.5mm Crimp Style Connector |
| DWN | VIEW: | PART NO.: X2513HL-XX-N0 |
| CHKD | UNIT: mm/in | DWG NO.: X-X2513HL-XX-N0 |
| APPD | SIZE: A4 | WEIGHT SHEET REVISION 1/1 A0 |

XKB INDUSTRIAL PRECISION CO., LIMITED

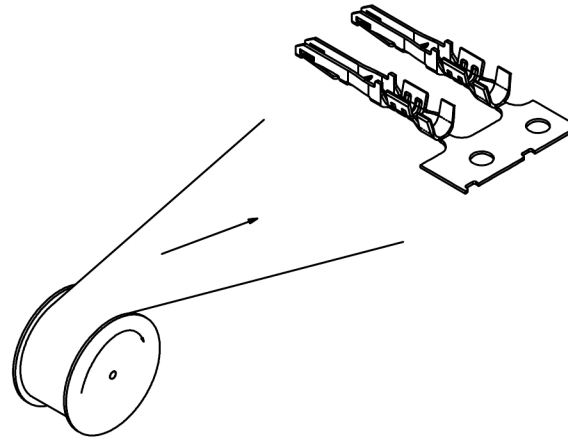
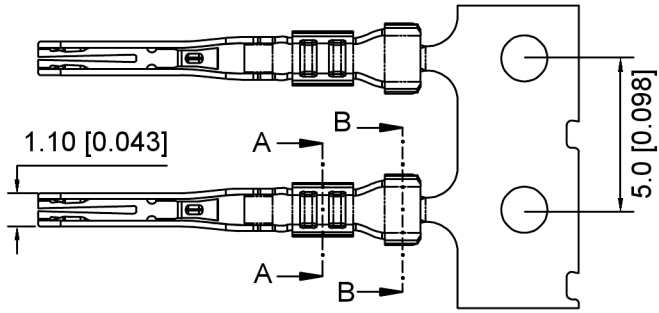

Specifications:

规格:

Voltage rating:250V AC/DC

额定电压: 250V AC/DC

Current rating:4A AC/DC

额定电流: 4A AC/DC

Withstanding voltage:1500V AC/minute

耐受电压: 1500V AC/分钟

Temperature range:-40°C-+105°C

温度范围: -40°C-+105°C

Insulation resistance:1000MΩ min

绝缘电阻: 1000MΩ Min

Contact resistance:30mΩ Max

接触电阻: 30mΩ Max

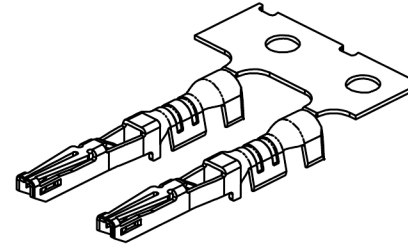
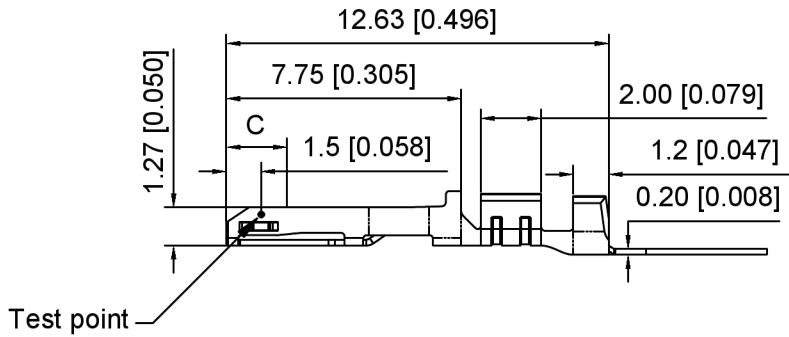

X2513 T - P V01 - X
① ② ③ ④ ⑤

1. Series No
2. Category:T-Terminal
3. Material :P-Phosphor Bronze
H-High Conductivity Copper Alloy
4. Plating:V01-Gold Flash
5. Special N0:H-High foot For #20~22AWG
L-Low foot For #24~26AWG

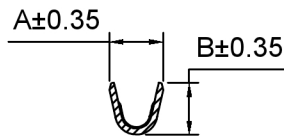

SEC:A-A

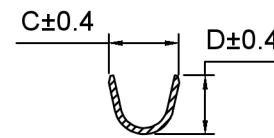

SEC:B-B

| | | | | | |
|--------------|------------|-------|-------|-------|-------|
| X2513T-PSN-H | AWG#20~22 | 1.80 | 1.85 | 2.33 | 1.94 |
| X2513T-PSN-L | AWG#24~26 | 1.39 | 1.45 | 2.12 | 2.00 |
| PART NO | Wire Range | DIM.A | DIM.B | DIM.C | DIM.D |

| | | | |
|--------------|-----------------|----------------------|--------------------|
| X2513T-PSN-X | Phosphor Bronze | X2513H | X2513W |
| PART NO | Material | Suitable XKB Housing | Suitable XKB Wafer |

| | | | |
|------|--|-------------|--|
| DSND | | SCALE: N/A | MODEL TYPE: 2.5mm Crimp Style Connector |
| DWN | | VIEW: | PART NO.: X2513T-PSN-X |
| CHKD | | UNIT: mm/in | DWG NO.: X-X2513T-PSN-X |
| APPD | | SIZE: A4 | |



XKB INDUSTRIAL PRECISION CO., LIMITED

| | | |
|--------|-------|----------|
| WEIGHT | SHEET | REVISION |
| | 1/1 | A0 |

广东星坤科技股份有限公司

| | |
|----|----|
| Δ建 | 日期 |
| Δ改 | |
| Δ修 | |
| Δ查 | |

MARK DESCRIPTION DATE REVISED APPROVED

文件工程章 REVISIONS UNSPECIFIED TOLERANCES