



CGS | CGS 3504

TE Internal #: 5-2176529-9

205 Ω, Thin Film, Power Resistor, 1 %, 2 Termination, 2512, Taped & Reeled, 6 W, ±50 ppm/°C, Solder, Height .017 in [.43 mm], CGS 3504

[View on TE.com >](#)

Passive Components > Resistors > Surface Mount Resistors



Resistor Type: **Power Resistor**

Number of Terminations: **2**

Package Size Code: **2512**

Packaging Method: **Taped & Reeled**

Passive Component Tolerance: **1 %**

Features

Product Type Features

Resistor Type	Power Resistor
Package Size Code	2512
Element Type	Thin Film

Configuration Features

Number of Resistors	1
---------------------	---

Electrical Characteristics

Operating Voltage	100 V
Passive Component Tolerance	1 %
Resistance Class	Up to 1kΩ
Resistance Value	205 Ω
Power Rating	6 W

Termination Features

Number of Terminations	2
Surface Mount Resistor Termination Type	Solder



Dimensions

Product Height	.43 mm[.017 in]
Product Length	6.3 mm[.248 in]
Product Width	3.1 mm[.122 in]

Usage Conditions

Operating Temperature Range	-55 – 155 $^{\circ}\text{C}$
Temperature Coefficient	± 50 ppm/ $^{\circ}\text{C}$

Packaging Features

Packaging Method	Taped & Reeled
------------------	----------------

Product Compliance

[For compliance documentation, visit the product page on TE.com>](#)

EU RoHS Directive 2011/65/EU	Compliant
EU ELV Directive 2000/53/EC	Compliant
China RoHS 2 Directive MIIT Order No 32, 2016	No Restricted Materials Above Threshold
EU REACH Regulation (EC) No. 1907/2006	Current ECHA Candidate List: JUNE 2023 (235) Candidate List Declared Against: JUNE 2023 (235) Does not contain REACH SVHC
Halogen Content	BFR/CFR/PVC Free, but Br/Cl >900 ppm in other sources.
Solder Process Capability	Reflow solder capable to 260 $^{\circ}\text{C}$

Product Compliance Disclaimer

This information is provided based on reasonable inquiry of our suppliers and represents our current actual knowledge based on the information they provided. This information is subject to change. The part numbers that TE has identified as EU RoHS compliant have a maximum concentration of 0.1% by weight in homogenous materials for lead, hexavalent chromium, mercury, PBB, PBDE, DBP, BBP, DEHP, DIBP, and 0.01% for cadmium, or qualify for an exemption to these limits as defined in the Annexes of Directive 2011/65/EU (RoHS2). Finished electrical and electronic equipment products will be CE marked as required by Directive 2011/65/EU. Components may not be CE marked. Additionally, the part numbers that TE has identified as EU ELV compliant have a maximum concentration of 0.1% by weight in homogenous materials for lead, hexavalent chromium, and mercury, and 0.01% for cadmium, or qualify for an exemption to these limits as defined in the Annexes of Directive 2000/53/EC (ELV). Regarding the REACH Regulation, the information TE provides on SVHC in articles for this part number is based on the latest European Chemicals Agency (ECHA) 'Guidance on requirements for substances in articles' posted at this URL: <https://echa.europa.eu/guidance-documents/guidance-on-reach>

Compatible Parts



Also in the Series | CGS 3504

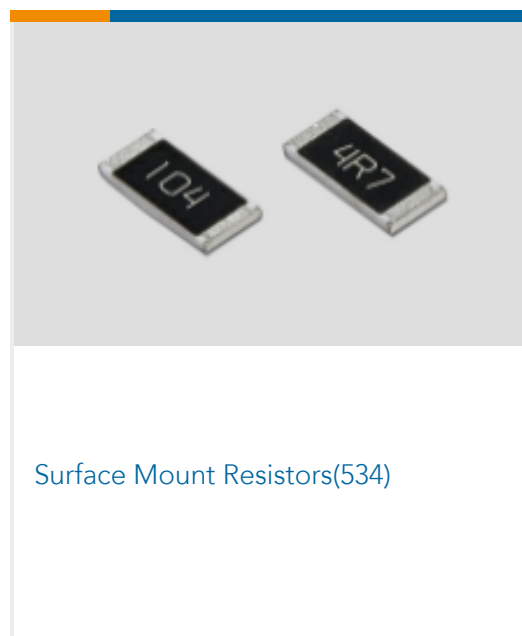

Customers Also Bought

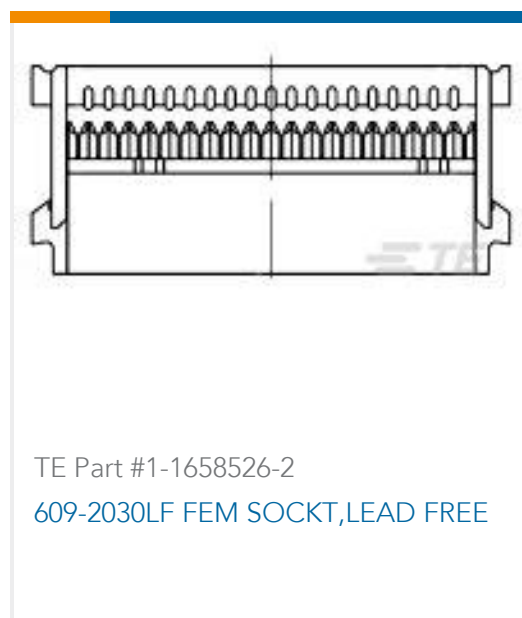

Documents

Product Drawings

3504G 3A 205R 1% 1K RL

English

CAD Files

Customer View Model

[ENG_CVM_CVM_5-2176529-9_A.3d_igs.zip](#)

English

Customer View Model

[ENG_CVM_CVM_5-2176529-9_A.3d_stp.zip](#)

English

Customer View Model

[ENG_CVM_CVM_5-2176529-9_A.2d_dxf.zip](#)

English

[3D PDF](#)

3504G3A205RFTDF

205 Ω , Thin Film, Power Resistor, 1 %, 2 Termination, 2512, Taped & Reeled, 6 W, ± 50 ppm/ $^{\circ}\text{C}$, Solder, Height .017 in [.43 mm], CGS 3504



3D

By downloading the CAD file I accept and agree to the [Terms and Conditions](#) of use.

[Datasheets & Catalog Pages](#)

[1773270-5](#)

English