

GENERAL DESCRIPTION

The LW31XX Series is a group of voltage regulators with high accuracy, high speed, low drop-out, high ripple rejection and fast discharge function.

The current limiter's fold-back circuit operates as a short circuit protection as well as the output current limiter for the output pin.

Output voltage is selectable from 1.2V to 5.0V which fixed by laser trimming technologies, Step=100mV.

The LW31XX Series is available in SOT23, SOT23-3L, SOT23-5L and DFN1x1-4L packages.

FEATURES

- Output Accuracy: $\pm 1.0\%$
- Low Quiescent Current: 40uA
- Low Dropout Voltage: 120mV@100mA/3.3V
- High PSRR: 80dB@1KHz, 10mA
- Output Current: 500mA
- Excellent Line and Load Transient Response
- Operating Voltage Range: from 1.8V to 7.0V
- Output Voltage Range: from 1.2V to 5.0V
- Over-Temperature Protection
- Current Limiting Protection
- Output Short-Circuit Protection
- Available in SOT23, SOT23-3L, SOT23-5L and DFN1x1-4L Packages

APPLICATIONS

- Battery-Powered Devices
- Reference Voltage Sources
- Other Low Voltage Power Suppliers

TYPICAL APPLICATION CIRCUIT

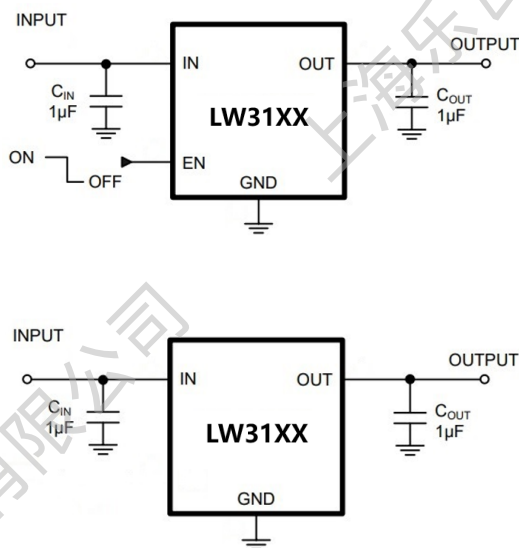

TYPICAL PERFORMANCE CHARACTERISTICS

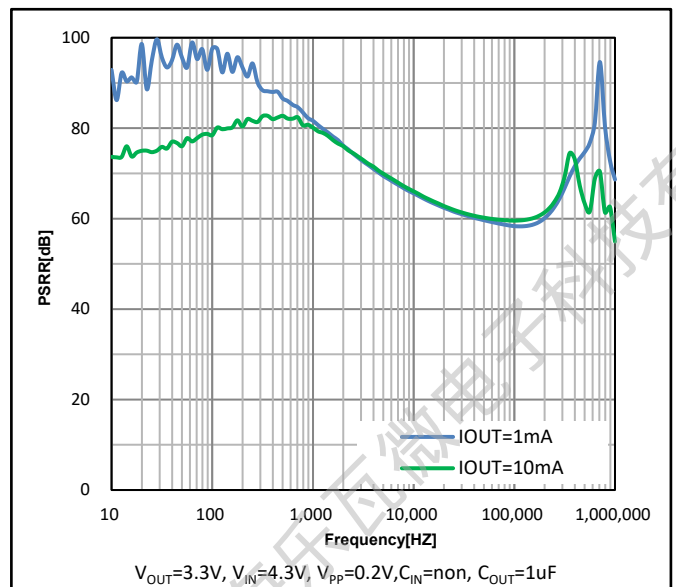

PIN DESCRIPTION:

PIN No				SYMBOL	DESCRIPTION
SOT23	SOT23-3L	SOT23-5L	DFN1x1-4L		
3	3	1	4	VIN	Power Supply Input
1	1	2	2,E-PAD	GND	Ground
--	--	3	3	EN	Chip Enable
--	--	4	--	NC	Not Connected
2	2	5	1	VOUT	Output

PIN ASSIGNMENT

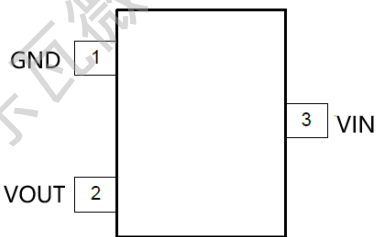

SOT23/SOT23-3L

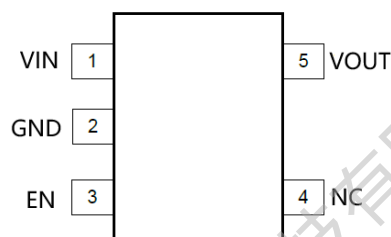

SOT23-5L

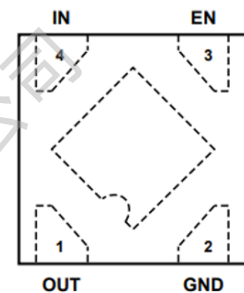

DFN1x1-4L

MARK INFORMATION:

SOT23

XX: VOLTAGE

YY: DATE CODE

31XXYY

SOT23-3/5L

XX: VOLTAGE

YY: DATE CODE

LW31XX
• YYYYY

DFN1x1-4L

X: VOLTAGE

31X

1.2V	1.5V	1.8V	2.5V	2.8V	3.0V	3.3V	3.6V	4.2V	5.0V
C	D	G	H	J	L	M	P	S	T

ABSOLUTE MAXIMUM RATINGS ⁽¹⁾:

(T_A =25°C, unless otherwise specified.)

SYMBOL	ITEM	RATING	UNIT
V _{IN}	Supply Voltage	-0.3~8.0	V
V _{EN}	EN Pin Voltage	-0.3~8.0	V
V _{OUT}	VOUT pin Voltage	-0.3~ (V _{IN} +0.3)	V
V _(ESD)	ESD Susceptibility, HBM ⁽²⁾	±2000	V
PD	Maximum Power Dissipation	SOT23	285
		SOT23-3/5L	450
		DFN1x1-4L	350
PTR	Package Thermal Resistance Θ _{JA}	SOT23	350
		SOT23-3/5L	220
		DFN1x1-4L	280
T _J	Junction Temperature Range	-40~150	°C
T _{STG}	Storage Temperature Range	-40~150	°C
T _{SOLDER}	Lead Temperature (Soldering)	260°C, 10s	

Note:

1. Stresses beyond those listed under Absolute Maximum Ratings may cause permanent damage to the device. These are stress ratings only, and functional operation of the device at these or any other conditions beyond those indicated under Recommended Operating Conditions is not implied. Exposure to absolute-maximum-rated conditions for extended periods may affect device reliability

2: per ANSI/ESDA/JEDEC JS-001

RECOMMENDED OPERATING RANGE:

SYMBOL	ITEM	VALUE	UNIT
V _{IN}	VIN Supply Voltage	1.8~7.0	V
V _{EN}	EN Pin Voltage	0~7.0	V
V _{OUT}	VOUT Pin Voltage	1.2~5.0	V
I _{OUT}	Output Current	0~500	mA
T _J	Junction Temperature Range	-40~125	°C

ELECTRICAL CHARACTERISTICS:

($V_{IN}=V_{OUT}+1V$, $V_{OUT}=3.3V$, $C_{IN}=C_{OUT}=1\mu F$, $T_A=25^\circ C$, unless otherwise specified.)

Symbol	Parameter	Conditions	MIN	TYP	MAX	Units
V_{IN}	Input Voltage		1.8		7.0	V
V_{OUT}	Output Accuracy	$I_{OUT}=1mA$	-1.0		+1.0	%
I_{LIM}	Current Limit ⁽¹⁾	$V_{IN}=4.3V$, $V_{OUT}=3.3V$	520	650		mA
I_Q	Quiescent Current	$V_{IN}=V_{EN}=V_{OUT}+1V$, No Load		40	60	μA
I_{SHD}	Shutdown Current	$V_{IN}=7.0V$, $V_{EN}=0V$			0.1	μA
V_{DROP}	Dropout Voltage ⁽²⁾	$I_{OUT}=100mA$, $V_{OUT}=3.3V$		120		mV
		$I_{OUT}=300mA$, $V_{OUT}=3.3V$		380		
		$I_{OUT}=500mA$, $V_{OUT}=3.3V$		700		
S_{LINE}	Line Regulation	$V_{IN}=V_{OUT}+1V$ to 7.0V, $I_{OUT}=1mA$		0.05	0.1	%/V
S_{LOAD}	Load Regulation	$1mA \leq I_{OUT} \leq 500mA$		0.001	0.01	%/mA
I_{SHORT}	Short Current	$V_{OUT}=0V$		100		mA
V_{ENH}	EN High Voltage	$V_{IN}=1.8V$ to 7.0V, $I_{OUT}=1mA$	1.5			V
V_{ENL}	EN Low Voltage				0.4	V
T_{STR}	Startup Time	From V_{EN} 'L' → 'H' to 95%* V_{OUT} , $C_{OUT}=1\mu F$, No Load		60		μs
PSRR	Power Supply Rejection Ratio	$C_{IN}=None$, $V_{OUT}=3.3V$, $I_{OUT}=10mA$	$f=217Hz$		81	dB
			$f=1KHz$		80	
			$f=10KHz$		66	
T_{SD}	Thermal Shut Down	Temperature rising		155		$^\circ C$
ΔT_{SD}	TSD Hysteresis	Temperature falling		20		$^\circ C$
$R_{DISCHRG}$	R_{ON} of Discharge MOSFET	$V_{EN}=0V$		80		Ω

NOTES:

1. Guaranteed by design
2. The dropout voltage is defined as $V_{IN} - V_{OUT}$, when $V_{OUT}=95\%*V_{OUT(NOM)}$

SIMPLIFIED BLOCK DIAGRAM:

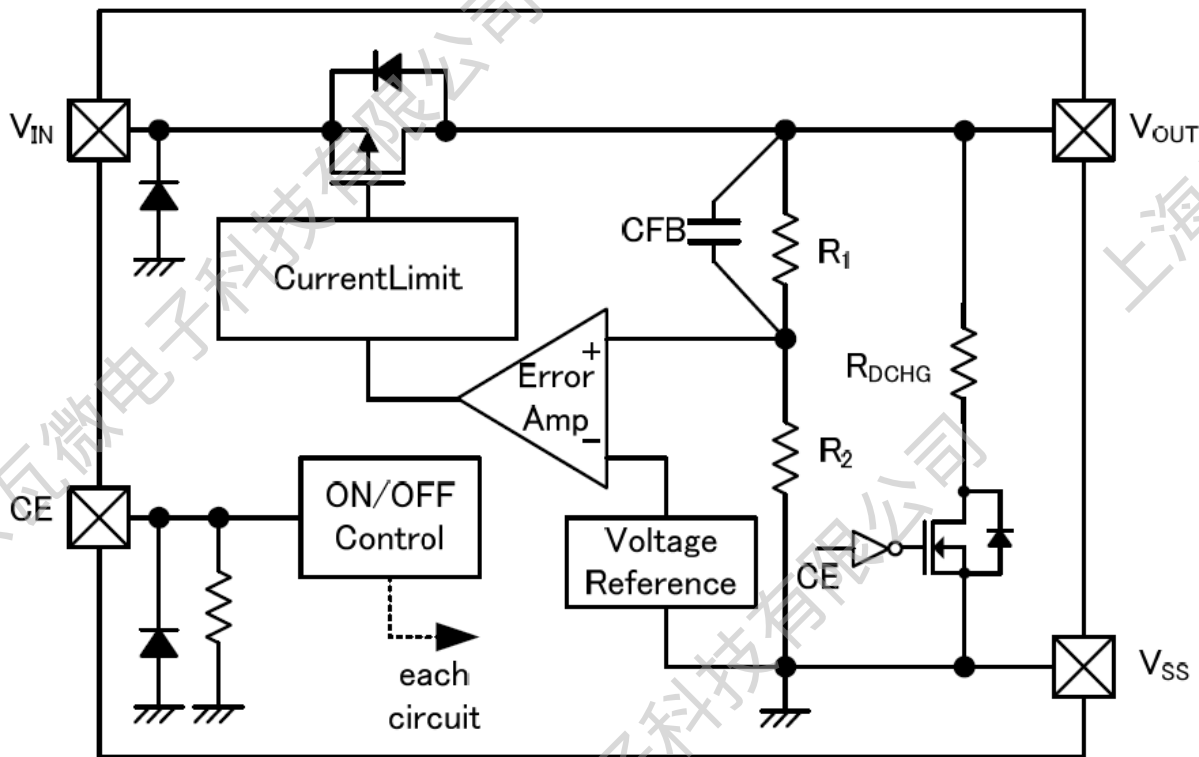

DETAIL OPERATION DESCRIPTION:

The LW31XX Series is a low noise, high PSRR, low drop-out voltage regulator. It consists of a current limiter circuit, a driver transistor, a precision voltage reference and an error correction circuit, and is compatible with low ESR ceramic capacitors. The current limiter's fold-back circuit operates as a short circuit protection as well as the output current limiter.

Current Limiting and Short-Circuit Protection

The current limit circuitry prevents damage to the MOSFET switch and the hub downstream port but can deliver load current up to the current limit threshold through the switch. When a heavy load or short circuit is applied to an enabled switch, a large transient current may flow until the current limit circuitry responds. Once this current limit threshold is exceeded the device enters constant current mode until the thermal shutdown occurs or the fault is removed.

TYPICAL OPERATING CHARACTERISTICS:

(Tested under $T_A = 25^\circ\text{C}$, unless otherwise specified)

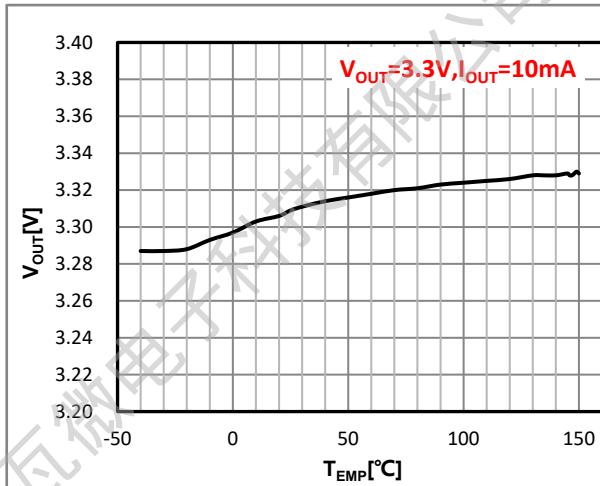

Figure 1. V_{OUT} vs Temperature

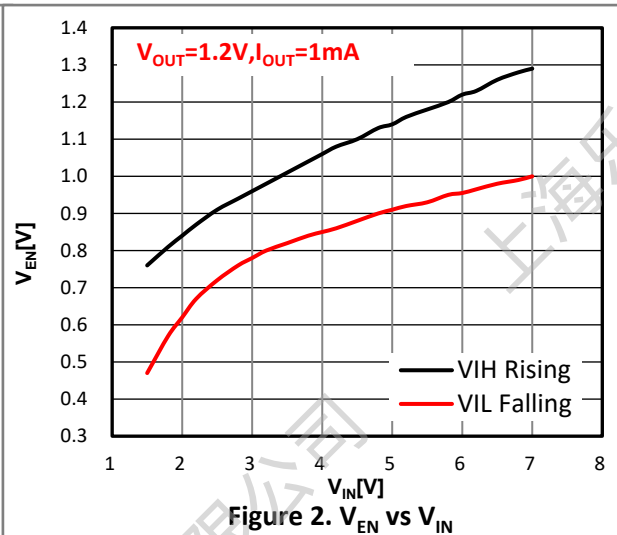

Figure 2. V_{EN} vs V_{IN}

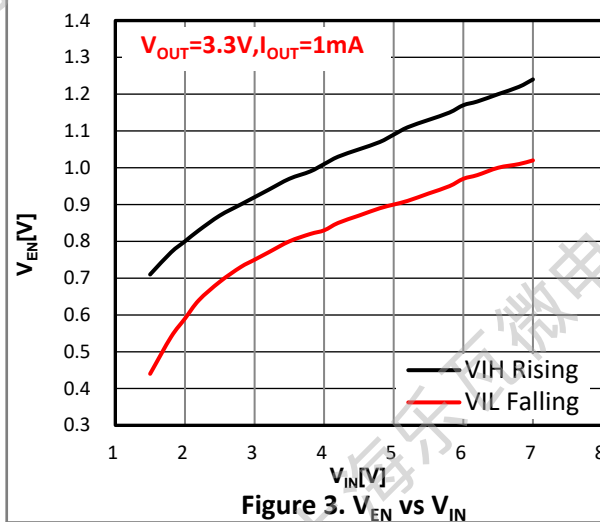

Figure 3. V_{EN} vs V_{IN}

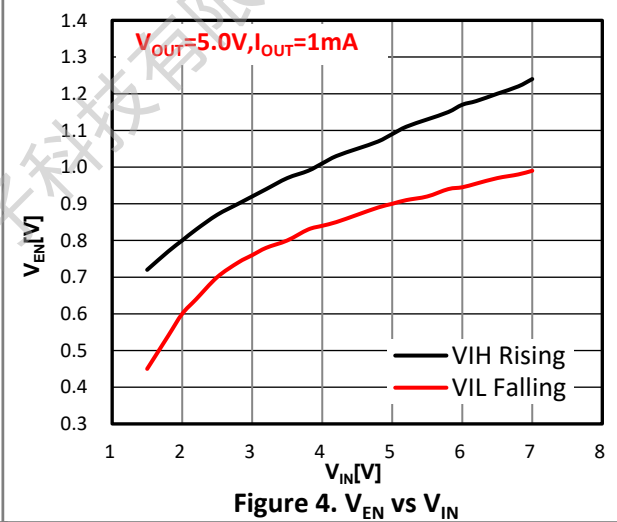

Figure 4. V_{EN} vs V_{IN}

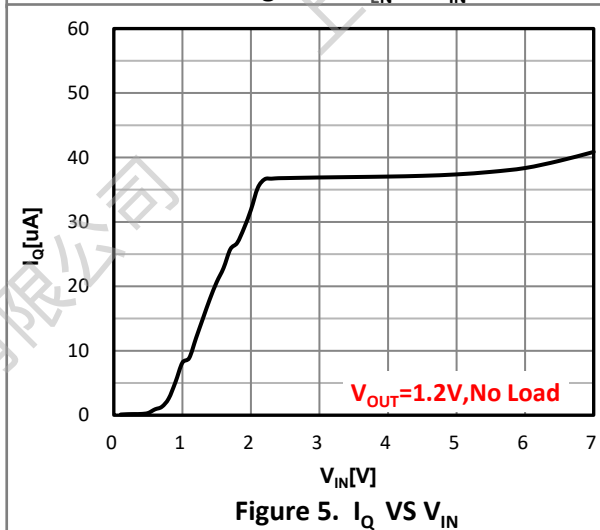

Figure 5. I_Q VS V_{IN}

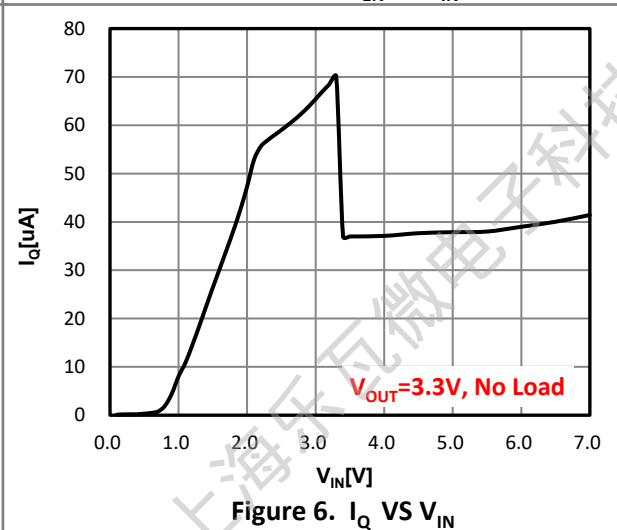
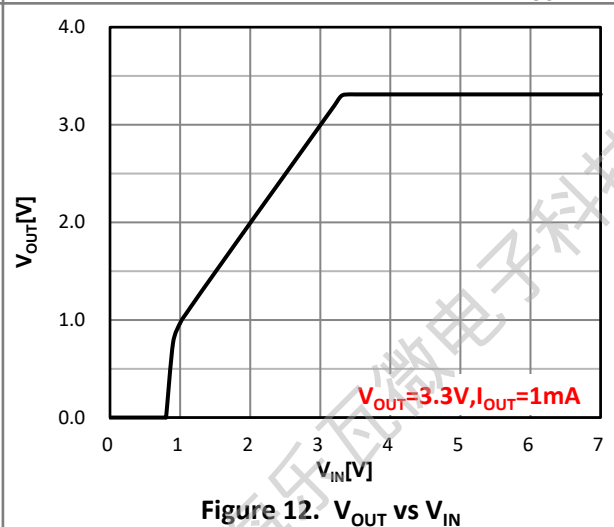
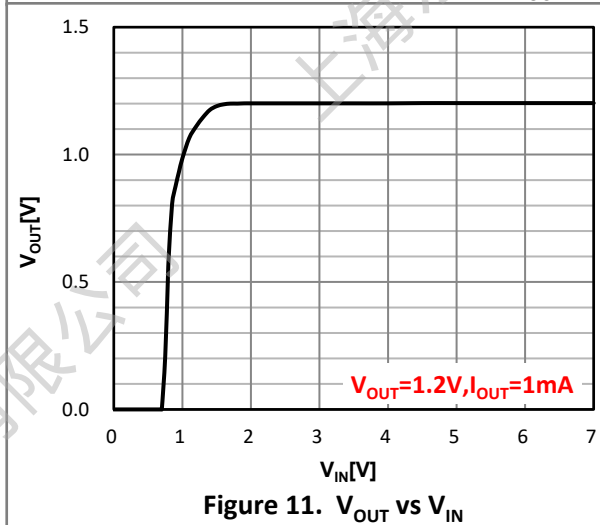
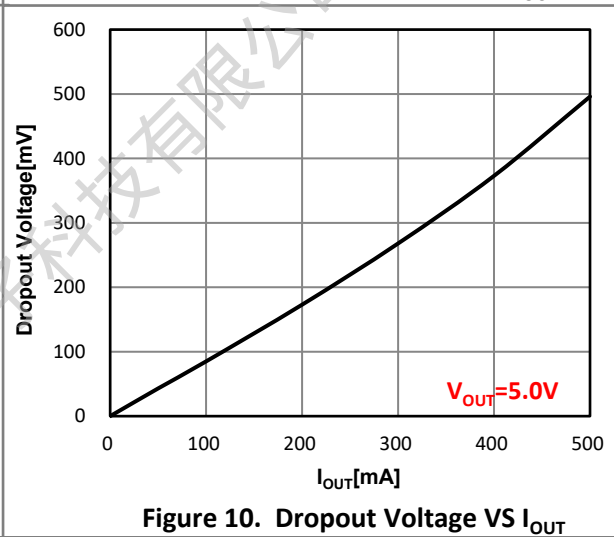
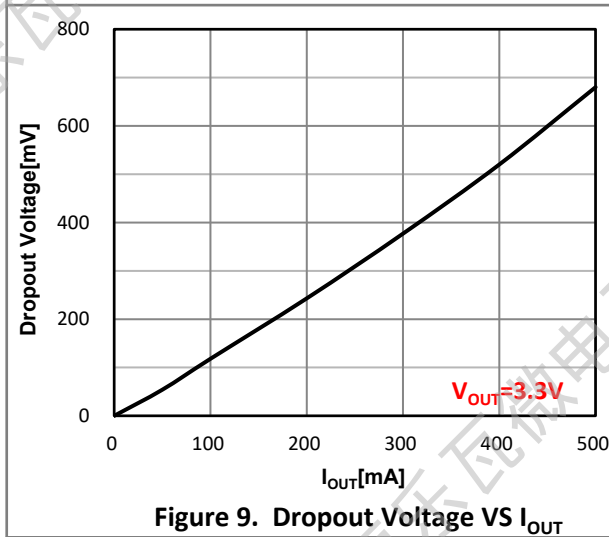
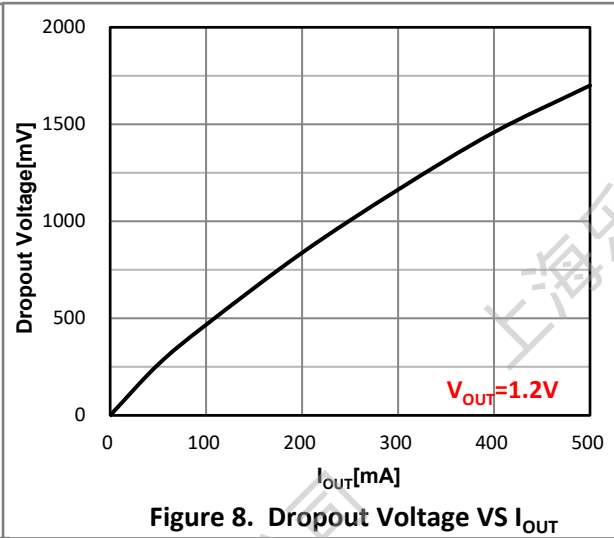
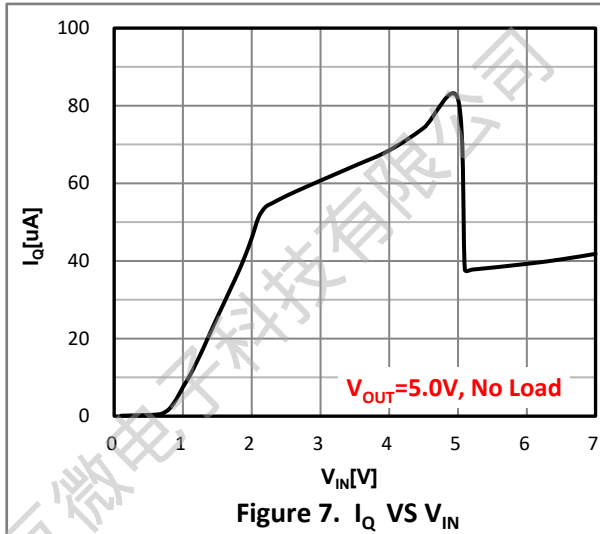

Figure 6. I_Q VS V_{IN}



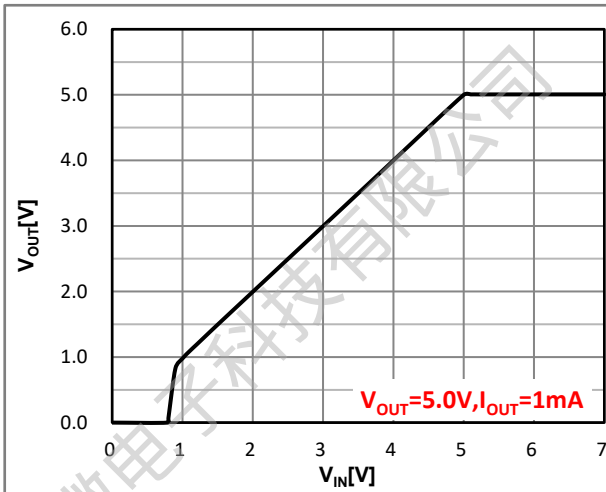

Figure 13. V_{OUT} vs V_{IN}

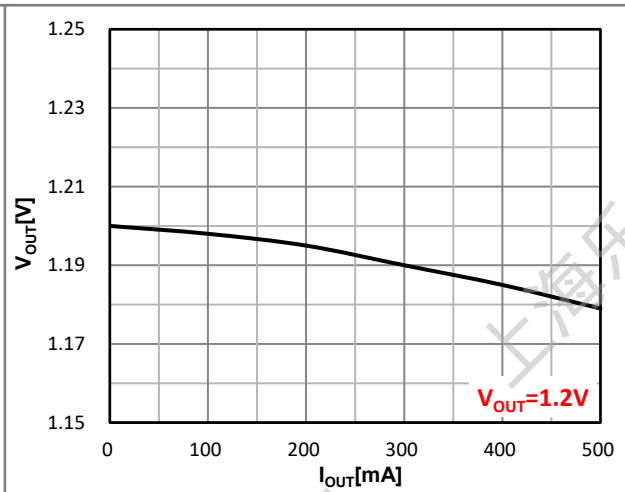

Figure 14. Load Regulation

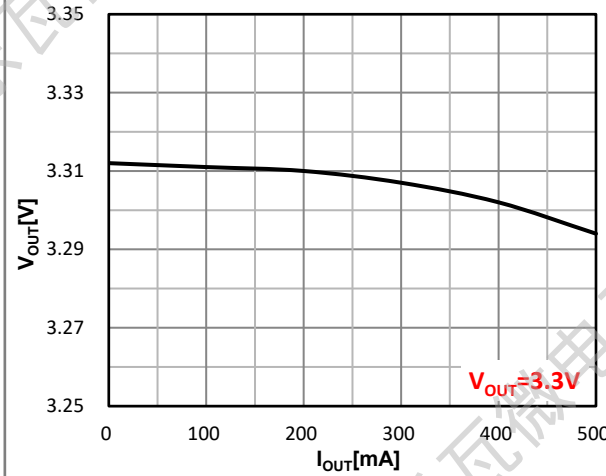

Figure 15. Load Regulation

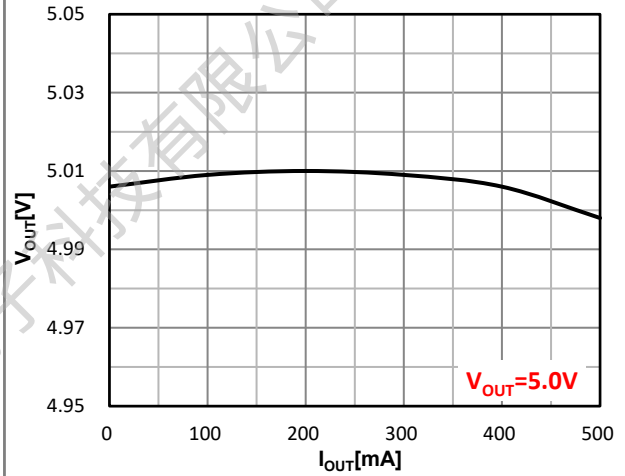
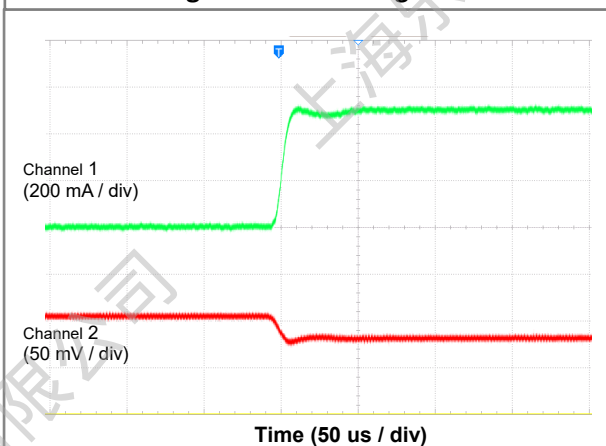
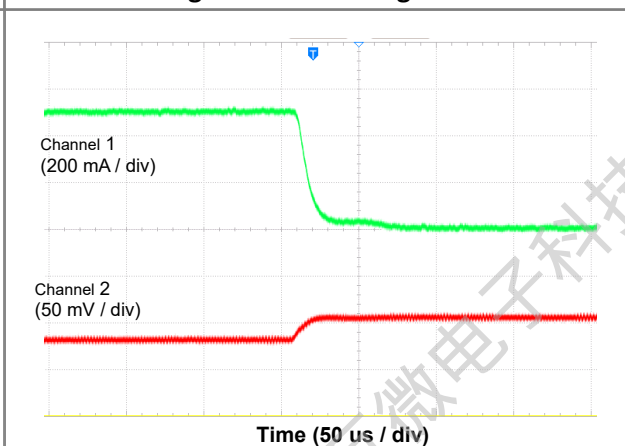

Figure 16. Load Regulation



Channel 1 = I_{OUT} , channel 2 = V_{OUT} , $V_{IN}=3.0V$, $V_{OUT}=1.2V$
 Figure 17. Load Transient (1 mA to 500 mA)



Channel 1 = I_{OUT} , channel 2 = V_{OUT} , $V_{IN}=3.0V$, $V_{OUT}=1.2V$
 Figure 18. Load Transient (500 mA to 1 mA)

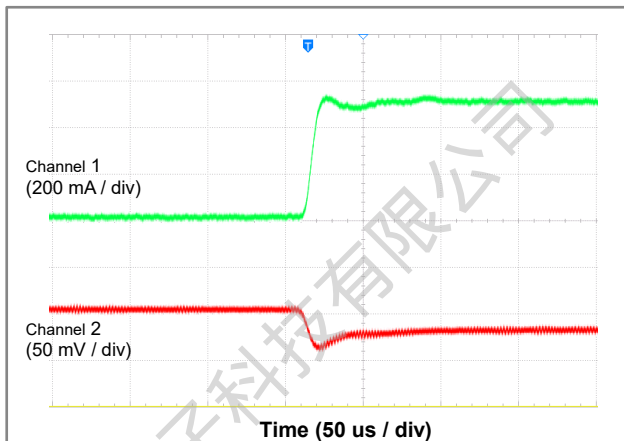

Channel 1 = I_{OUT} , channel 2 = V_{OUT} , $V_{IN}=4.3V$, $V_{OUT}=3.3V$

Figure 19. Load Transient (1 mA to 500 mA)

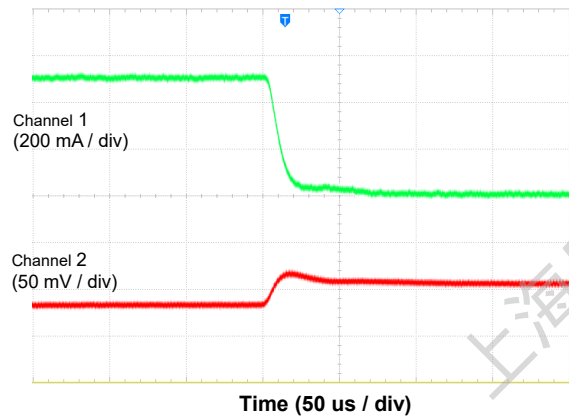

Channel 1 = I_{OUT} , channel 2 = V_{OUT} , $V_{IN}=4.3V$, $V_{OUT}=3.3V$

Figure 20. Load Transient (500 mA to 1 mA)

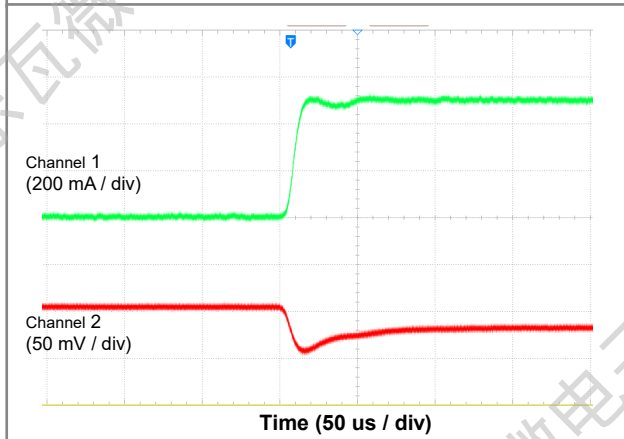

Channel 1 = I_{OUT} , channel 2 = V_{OUT} , $V_{IN}=6.0V$, $V_{OUT}=5.0V$

Figure 21. Load Transient (1 mA to 500 mA)

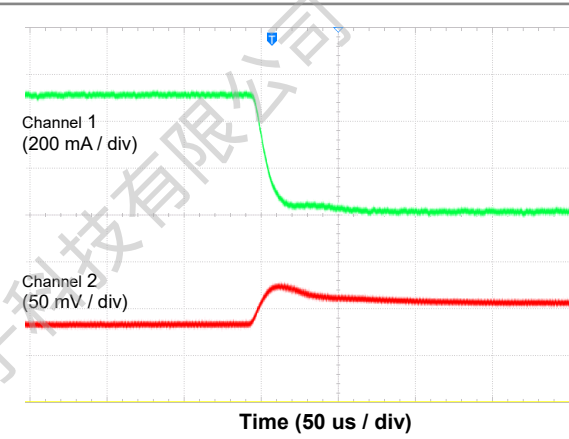

Channel 1 = I_{OUT} , channel 2 = V_{OUT} , $V_{IN}=6.0V$, $V_{OUT}=5.0V$

Figure 22. Load Transient (500 mA to 1 mA)

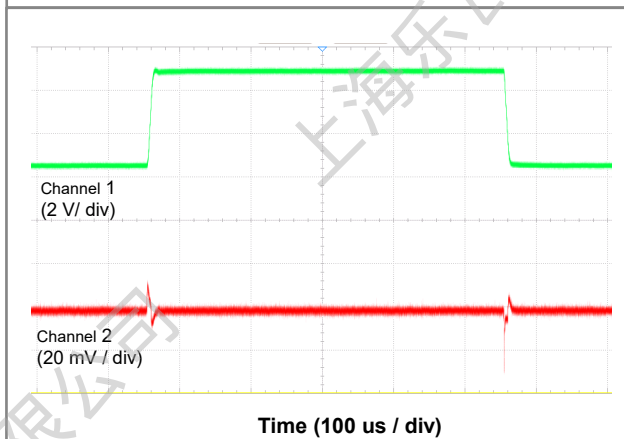

Channel 1 = V_{IN} , channel 2 = V_{OUT} , $V_{IN}=2.2V \rightarrow 7.0V$,
 $T_r=T_f=5\mu s$, $V_{OUT}=1.2V$, $I_{OUT}=10mA$

Figure 23. Line Transient

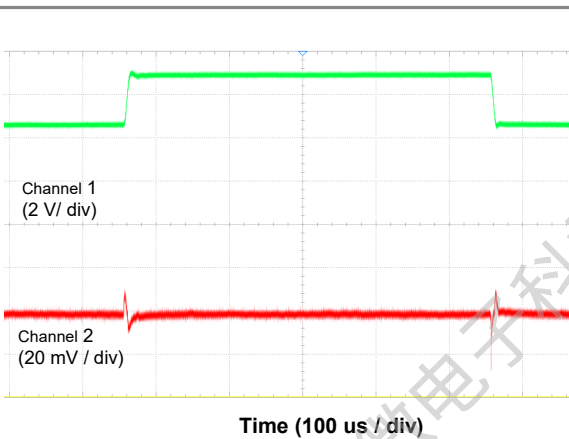

Channel 1 = V_{IN} , channel 2 = V_{OUT} , $V_{IN}=4.3V \rightarrow 7.0V$,
 $T_r=T_f=5\mu s$, $V_{OUT}=3.3V$, $I_{OUT}=10mA$

Figure 24. Line Transient

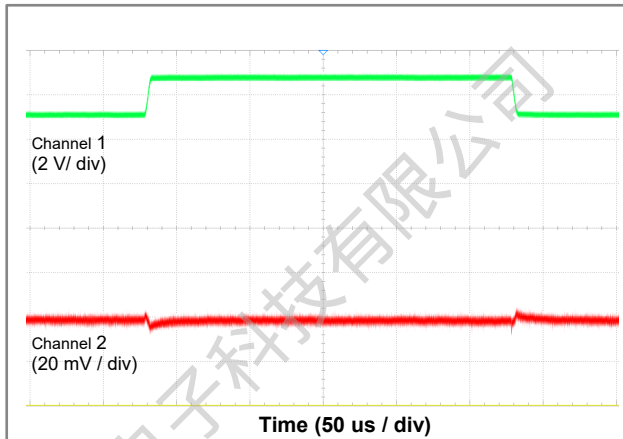

Channel 1 = V_{IN} , channel 2 = V_{OUT} , $V_{IN}=5.5V \rightarrow 7.0V$,
 $T_r=T_f=5\mu s$, $V_{OUT}=5.0V$, $I_{OUT}=10mA$

Figure 25. Line Transient

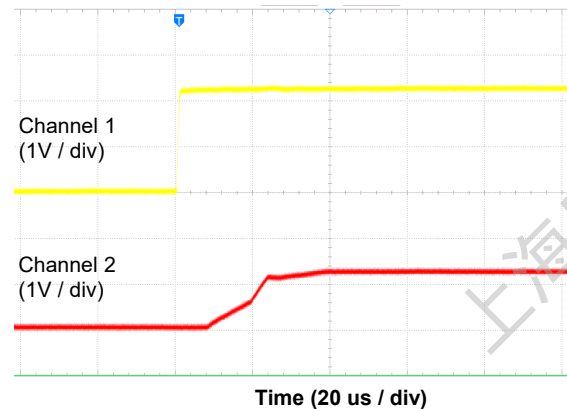

Channel 1 = En, channel 2 = V_{OUT} , $V_{OUT}=1.2V$, No Load

Figure 26. Power-Up with Enable

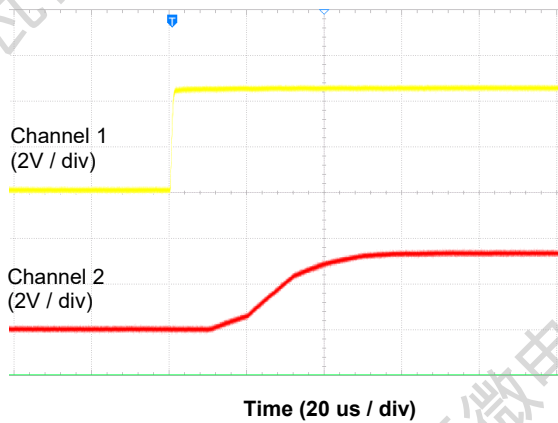

Channel 1 = En, channel 2 = V_{OUT} , $V_{OUT}=3.3V$, No Load

Figure 27. Power-Up with Enable

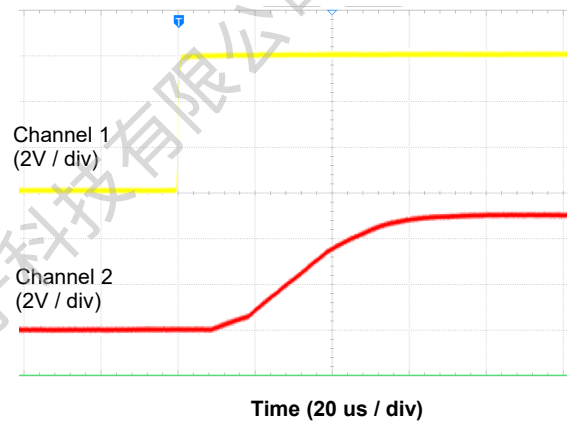

Channel 1 = En, channel 2 = V_{OUT} , $V_{OUT}=5.0V$, No Load

Figure 28. Power-Up with Enable

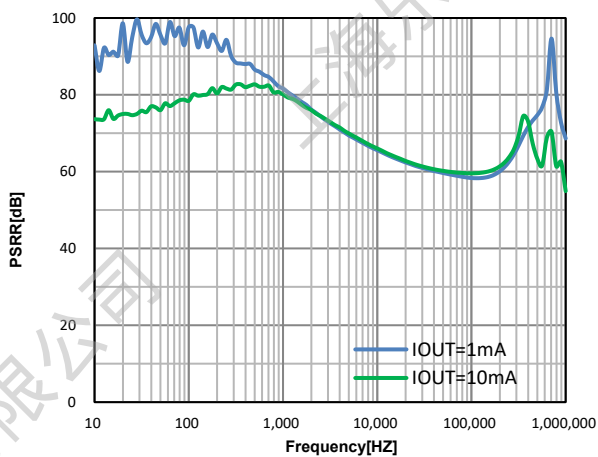

$V_{OUT}=3.3V$, $V_{IN}=4.3V$, $V_{PP}=0.2V$, $C_{IN}=non$, $C_{OUT}=1\mu F$

Figure 29. PSRR vs Frequency

APPLICATION INFORMATION:**● Input Capacitor Selection**

Like any low-dropout regulator, the external capacitors used with the LW31XX Series must be carefully selected for regulator stability and performance. Using a capacitor whose value is $\geq 1\mu\text{F}$ on the LW31XX Series input and the amount of capacitance can be increased without limit. An at least $10\mu\text{F}$ input capacitor is needed if input ripple voltage $V_{pp} > 1\text{V}$. The input capacitor must be located a distance less than 0.5 inch from the input pin of the IC and returned to a clean analog ground. Any good quality ceramic or tantalum can be used for this capacitor. The capacitor with larger value and lower ESR (equivalent series resistance) provides better PSRR and line-transient response.

● Layout considerations

To improve ac performance such as PSRR, output noise, and transient response, it is recommended that the PCB be designed with separate ground planes for VIN and VOUT, with each ground plane connected only at the GND pin of the device.

● Output Capacitor Selection

The output capacitor must meet both requirements for minimum amount of capacitance and ESR in all LDOs application. The LW31XX Series is designed specifically to work with low ESR ceramic output capacitor in space-saving and performance consideration. Using a ceramic capacitor whose value is at least $1\mu\text{F}$ on the LW31XX Series output ensures stability. An appropriate output capacitor can reduce noise and improve load transient response and PSRR. The output capacitor should be located not more than 0.5 inch from the VOUT pin of the LW31XX Series and returned to a clean analog ground.

ORDER INFORMATION:

LW31①②③④⑤⑥

Designator	Item	Symbol	Description
①②	Output Voltage	12~50	e.g.1.2V→①=1,②=2
③④⑤⑥	Packages	N23C	SOT23
		N23D	SOT23-3L
		A23E	SOT23-5L
		N11E	DFN1x1-4L

Part #	Output Voltage	Package	Shipping
LW3112N23C	1.2V	SOT23	3000 Pcs/ Tape & Reel
LW3115N23C	1.5V		
LW3118N23C	1.8V		
LW3125N23C	2.5V		
LW3128N23C	2.8V		
LW3130N23C	3.0V		
LW3133N23C	3.3V		
LW3136N23C	3.6V		
LW3142N23C	4.2V		
LW3150N23C	5.0V		
LW3112N23D	1.2V	SOT23-3L	3000 Pcs/ Tape & Reel
LW3115N23D	1.5V		
LW3118N23D	1.8V		
LW3125N23D	2.5V		
LW3128N23D	2.8V		
LW3130N23D	3.0V		
LW3133N23D	3.3V		
LW3136N23D	3.6V		
LW3142N23D	4.2V		
LW3150N23D	5.0V		

Part #	Output Voltage	Package	Shipping
LW3112A23E	1.2V	SOT23-5L	3000 Pcs / Tape & Reel
LW3115A23E	1.5V		
LW3118A23E	1.8V		
LW3125A23E	2.5V		
LW3128A23E	2.8V		
LW3130A23E	3.0V		
LW3133A23E	3.3V		
LW3136A23E	3.6V		
LW3142A23E	4.2V		
LW3150A23E	5.0V		
LW3112N11E	1.2V	DFN1x1-4L	10000 Pcs/ Tape & Reel
LW3115N11E	1.5V		
LW3118N11E	1.8V		
LW3125N11E	2.5V		
LW3128N11E	2.8V		
LW3130N11E	3.0V		
LW3133N11E	3.3V		
LW3136N11E	3.6V		
LW3142N11E	4.2V		
LW3150N11E	5.0V		

If customers have special output voltage requirements, please contact us.

PACKAGE OUTLINE:

SOT23 Package

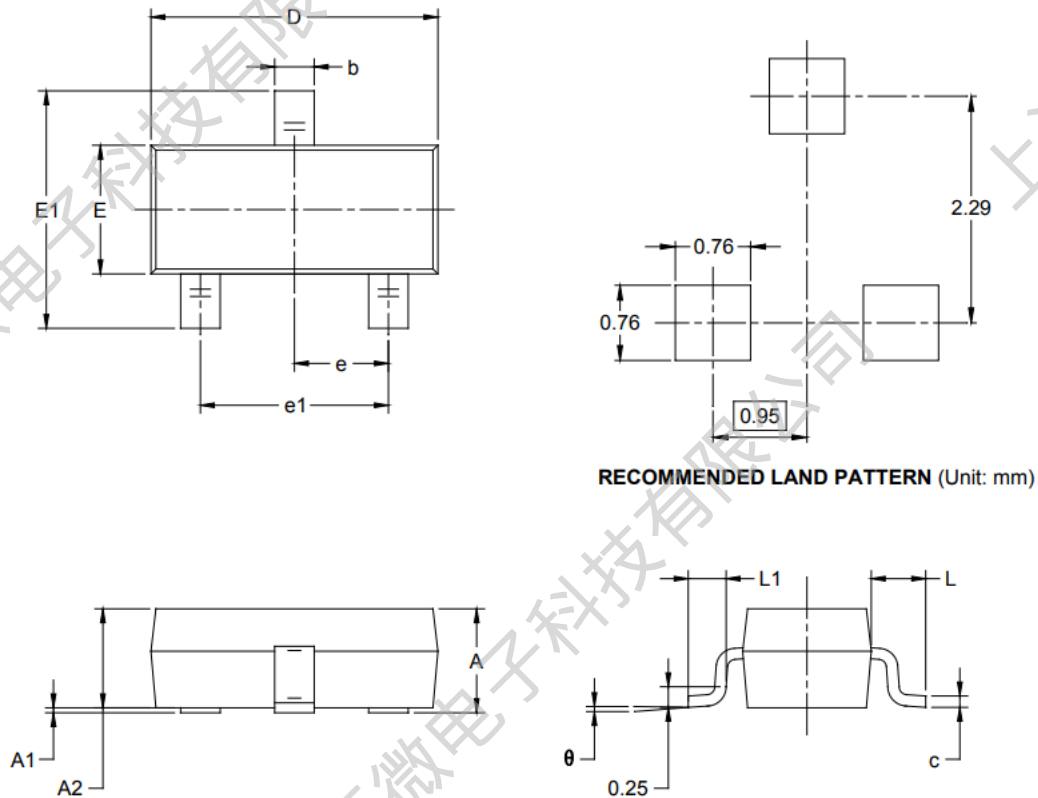

Symbol	Dimensions In Millimeters		Dimensions In Inches	
	MIN	MAX	MIN	MAX
A	0.900	1.150	0.035	0.045
A1	0.000	0.100	0.000	0.004
A2	0.900	1.050	0.035	0.041
b	0.300	0.500	0.012	0.020
c	0.080	0.150	0.003	0.006
D	2.800	3.000	0.110	0.118
E	1.200	1.400	0.047	0.055
E1	2.250	2.550	0.089	0.100
e	0.950 BSC		0.037 BSC	
e1	1.900 BSC		0.075 BSC	
L	0.550 REF		0.022 REF	
L1	0.300	0.500	0.012	0.020
θ	0°	8°	0°	8°

SOT23-3L Package

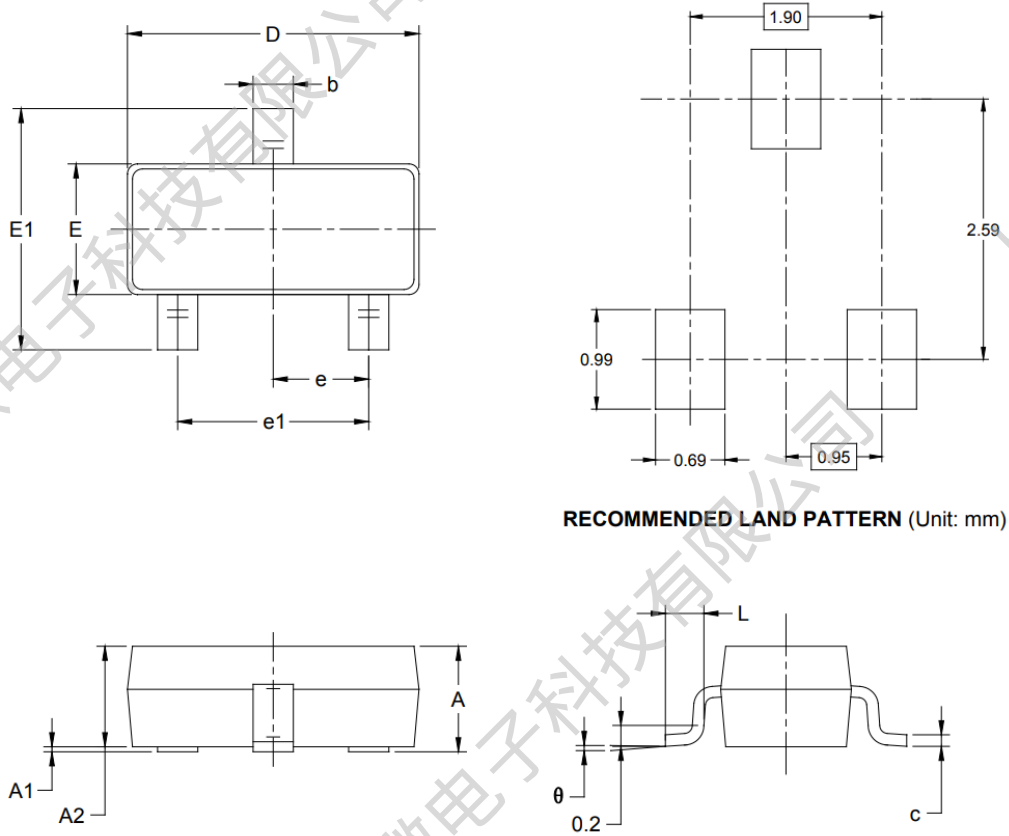

Symbol	Dimensions In Millimeters		Dimensions In Inches	
	MIN	MAX	MIN	MAX
A	1.050	1.250	0.041	0.049
A1	0.000	0.100	0.000	0.004
A2	1.050	1.150	0.041	0.045
b	0.300	0.500	0.012	0.020
c	0.100	0.200	0.004	0.008
D	2.820	3.020	0.111	0.119
E	1.500	1.700	0.059	0.067
E1	2.650	2.950	0.104	0.116
e	0.950 BSC		0.037 BSC	
e1	1.900 BSC		0.075 BSC	
L	0.300	0.600	0.012	0.024
θ	0°	8°	0°	8°

SOT23-5L Package

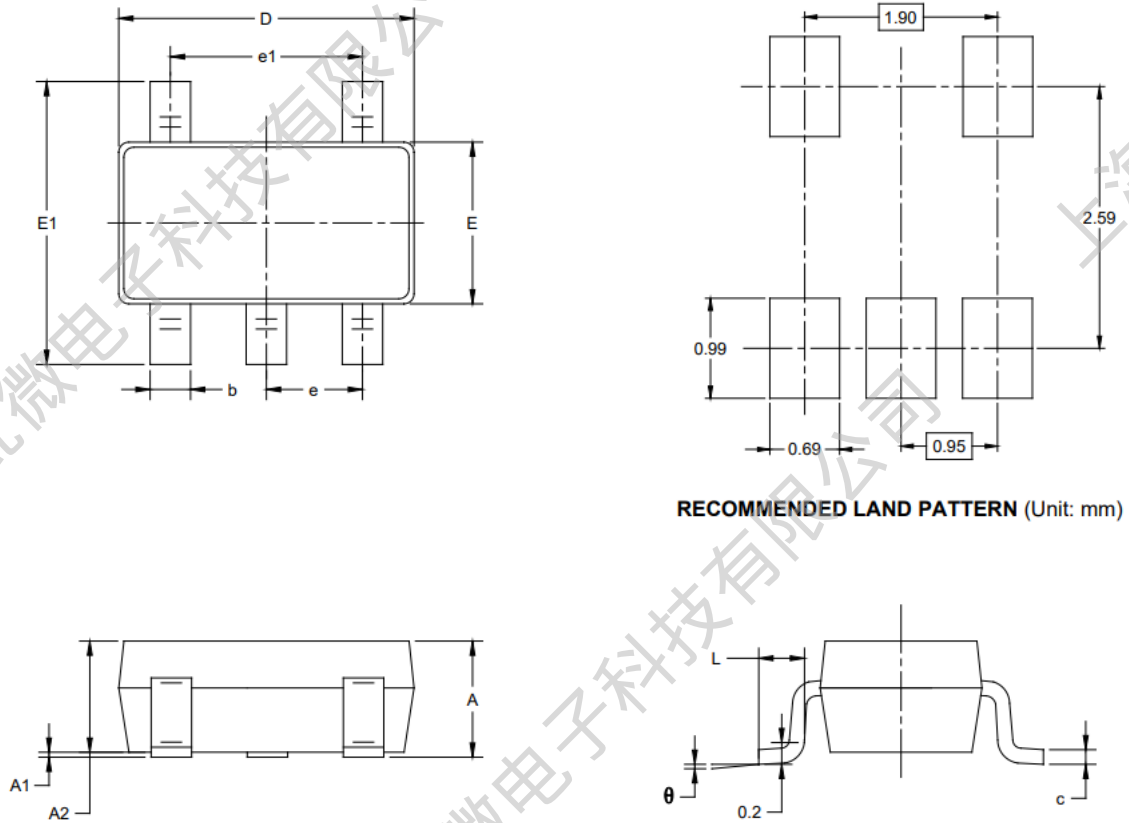

Symbol	Dimensions In Millimeters		Dimensions In Inches	
	MIN	MAX	MIN	MAX
A	1.050	1.250	0.041	0.049
A1	0.000	0.100	0.000	0.004
A2	1.050	1.150	0.041	0.045
b	0.300	0.500	0.012	0.020
c	0.100	0.200	0.004	0.008
D	2.820	3.020	0.111	0.119
E	1.500	1.700	0.059	0.067
E1	2.650	2.950	0.104	0.116
e	0.950 BSC		0.037 BSC	
e1	1.900 BSC		0.075 BSC	
L	0.300	0.600	0.012	0.024
θ	0°	8°	0°	8°

DFN1x1-4L Package

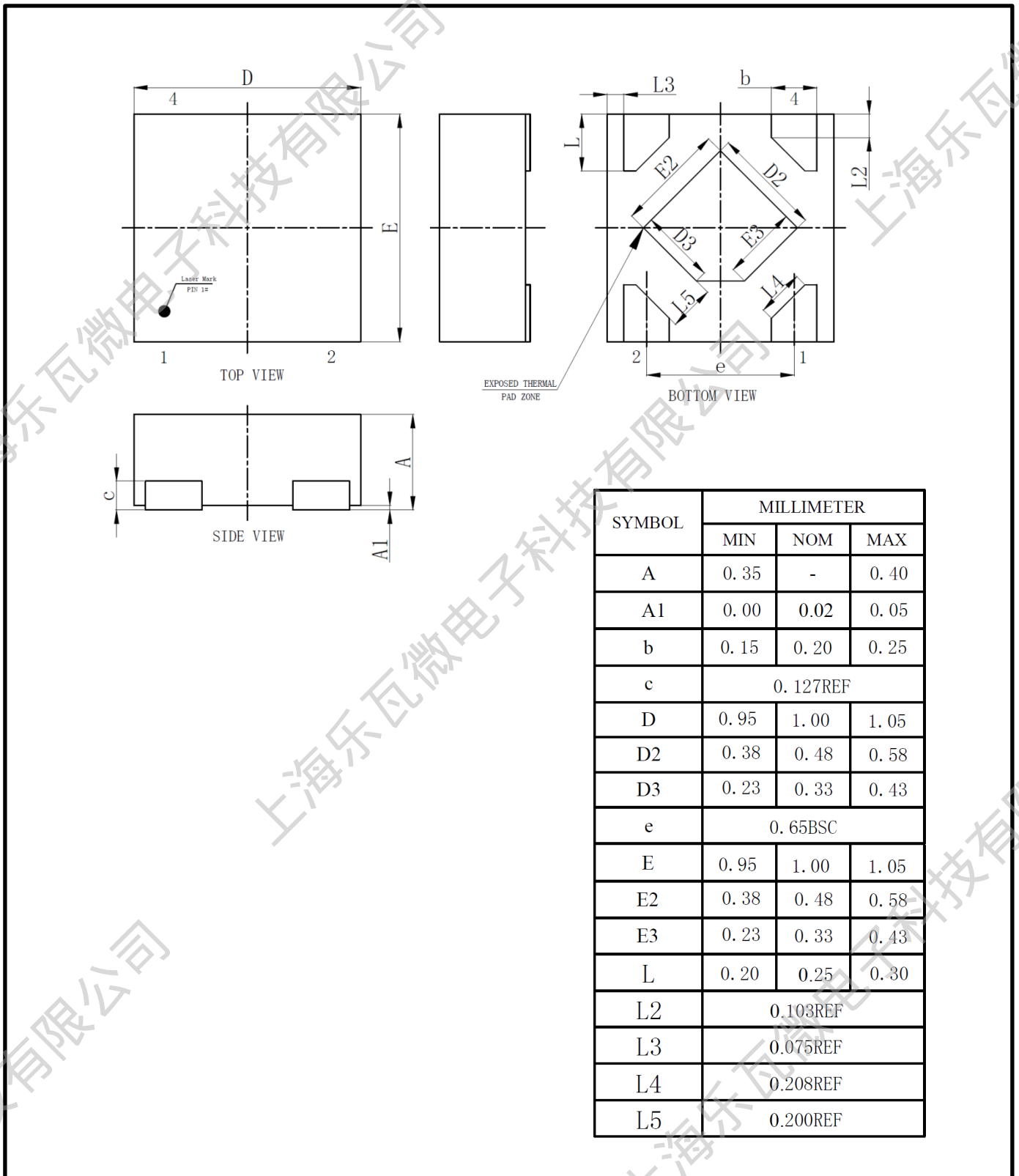

Revision History:

Revision	Date	Descriptions
Rev 0.1	Jun.2023	Initial Version
Rev 1.0	Oct.2023	Formal Version

DISCLAIMER:

The information in this document is believed to be accurate and reliable. However, no responsibility is assumed by LW-Micro for its use. All operating parameters must be designed, validated and tested to ensure they meet the requirements of your application. LW-Micro reserves the right to make any specification and/or circuitry changes without prior notification. Before starting a brand-new project, please contact LW-Micro Sales to get the most recent relevant information.

Mailing Address: Room 301, Building 2, No.1690 CaiLun Road, China (Shanghai) Pilot Free Trade Zone
Shanghai Lewa Micro-electronics Technology Co., Ltd