

YHD36-24-91SE00000 ✓ ACTIVE

DEUTSCH HD, DEUTSCH HD30

TE Internal #: YHD36-24-91SE00000

TE Internal Description: PLG, 9P, AL, E, 8/12/16, S

DEUTSCH HD30 Housings

[View on TE.com >](#)



[All DEUTSCH HD30 Housings \(358\)](#)

Product Compliance

[For compliance documentation, visit the product page on TE.com>](#)

EU RoHS Directive 2011/65/EU	Compliant with Exemptions
EU ELV Directive 2000/53/EC	Compliant with Exemptions
China RoHS 2 Directive MIIT Order No 32, 2016	Restricted Materials Above Threshold
EU REACH Regulation (EC) No. 1907/2006	Current ECHA Candidate List: JUNE 2023 (235) Candidate List Declared Against: JAN 2023 (233) SVHC > Threshold: Pb (1.2% in Component Part) Article Safe Usage Statements: Do not eat, drink or smoke when using this product. Wash thoroughly after handling. Recycle if possible and dispose of the article by following all applicable governmental regulations relevant to your geographic location.
Halogen Content	Not Low Halogen - contains Br or Cl > 900 ppm.
Solder Process Capability	Not reviewed for solder process capability

Product Compliance Disclaimer

This information is provided based on reasonable inquiry of our suppliers and represents our current actual knowledge based on the information they provided. This information is subject to change. The part numbers that TE has identified as EU RoHS compliant have a maximum concentration of 0.1% by weight in homogenous materials for lead, hexavalent chromium, mercury, PBB, PBDE, DBP, BBP, DEHP, DIBP, and 0.01% for cadmium, or qualify for an exemption to these limits as defined in the Annexes of Directive 2011/65/EU (RoHS2). Finished electrical and electronic equipment products will be CE marked as required by Directive 2011/65/EU. Components may not be CE marked. Additionally, the part numbers that TE has identified as EU ELV compliant have a maximum concentration of 0.1% by weight in homogenous materials for lead, hexavalent chromium, and mercury, and 0.01% for cadmium, or qualify for an exemption to these limits as defined in the Annexes of Directive 2000/53/EC (ELV). Regarding the REACH Regulation, the information TE provides on SVHC in articles for this part number is based on the latest European Chemicals Agency (ECHA) 'Guidance on requirements for substances in articles' posted at this URL: <https://echa.europa.eu/guidance-documents/guidance-on-reach>

Compatible Parts

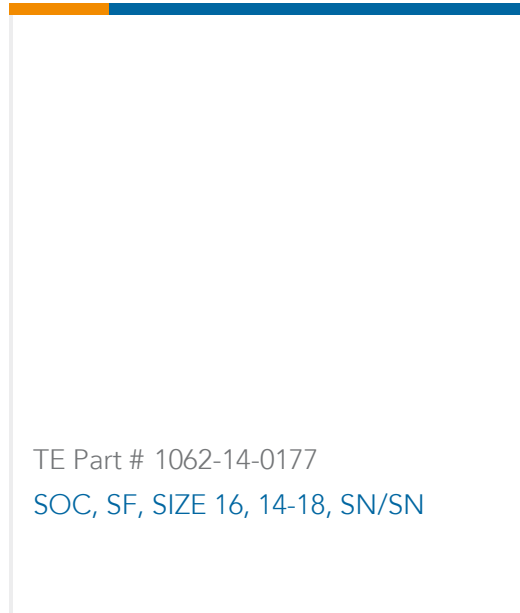
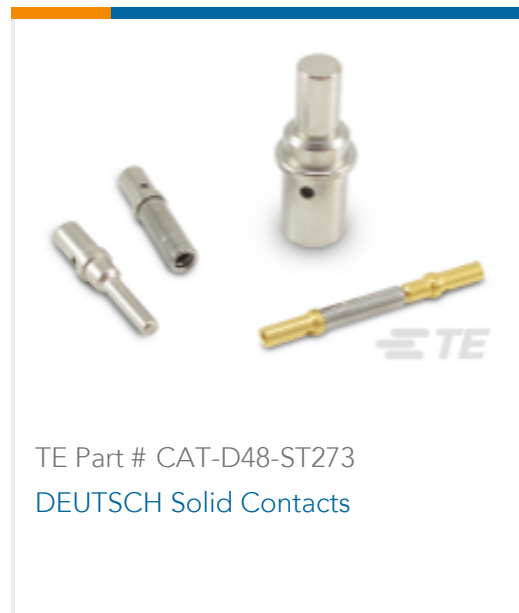

Also in the Series | DEUTSCH HD

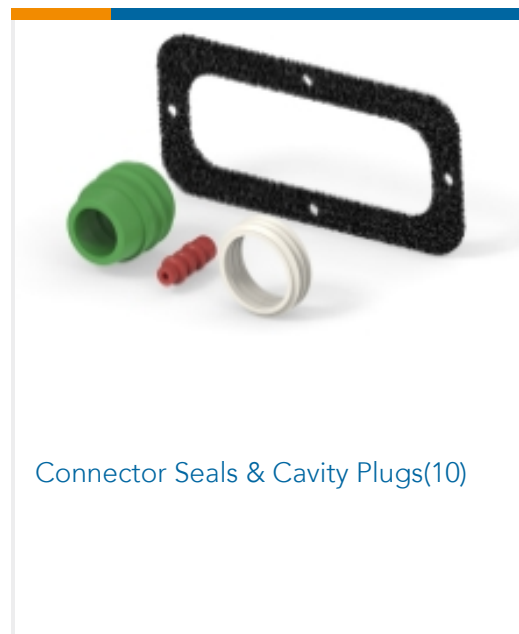
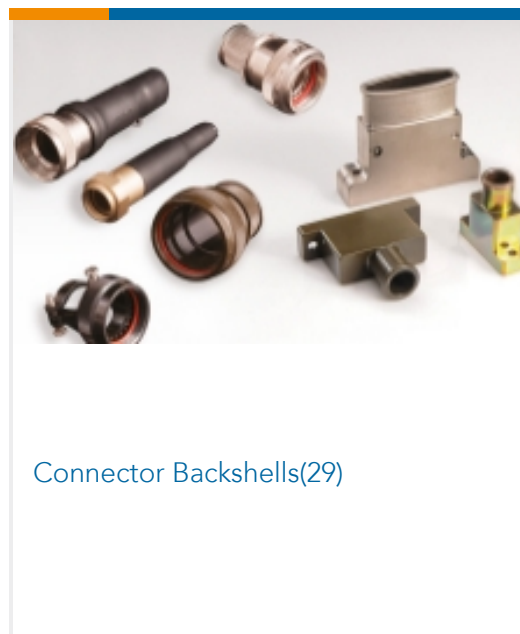
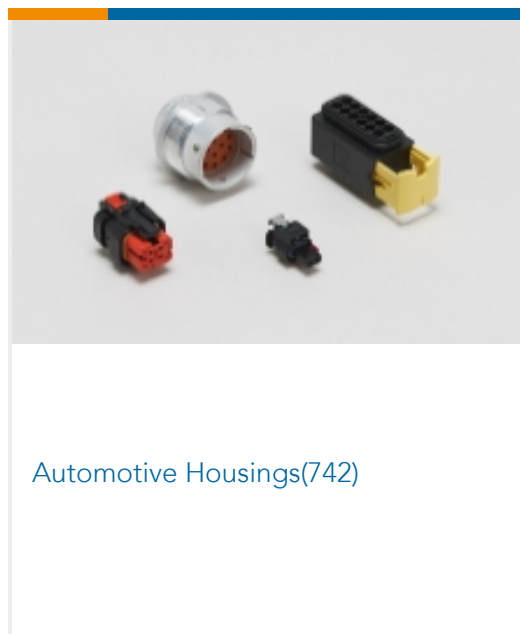



Connector Strain Relief(5)



Insertion & Extraction Tools(11)



Other Automotive Connector Accessories(11)

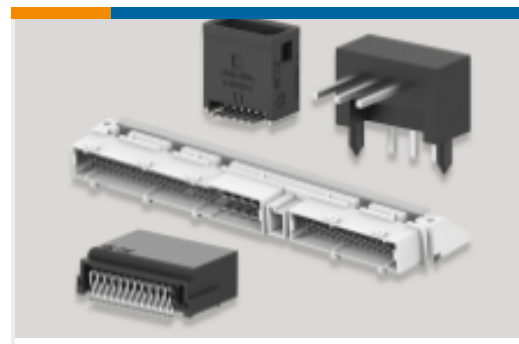

PCB Headers & Receptacles(1)

Also in the Series | DEUTSCH HD30



Automotive Connector Caps & Covers (14)

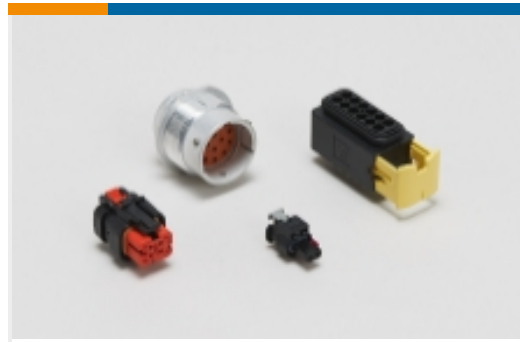

Automotive Housings(359)



Connector Backshells(2)



Connector Seals & Cavity Plugs(11)



Connector Strain Relief(5)



Insertion & Extraction Tools(10)



Other Automotive Connector Accessories(6)

Customers Also Bought



TE Part #DRC16-70SCE-P013
PLG, 70P, BLK, E, SEAL BOND, C



TE Part #HD34-18-21SN
DEUTSCH HD30 Housings

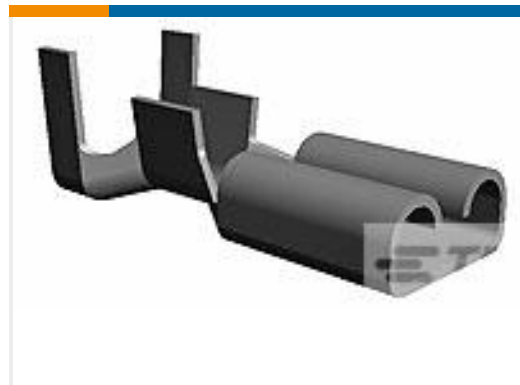

TE Part #170466-1
187 FASTON,REC.,18-14 AWG,TPBR

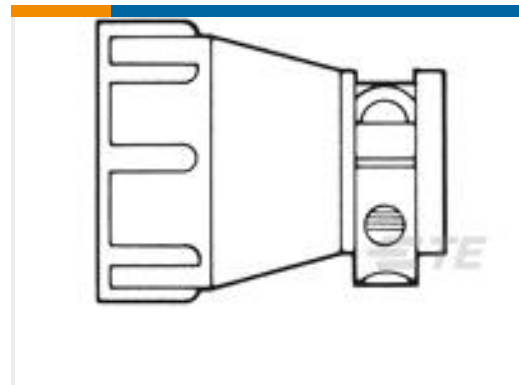

TE Part #1-206062-2
CABLE CLAMP KIT #11



TE Part #1-2366515-4
DYNAMIC D1000 SLIM REC HSG 4P X KEY



TE Part #1-2366600-4
DYNAMIC D1000 SLIM TAB HSG 4P X KEY



TE Part #2367819-2
DYNAMIC D1000SL TAB CONT M AU0.2 PLATING



Documents

Product Drawings

[PLG, 9P, AL, E, 8/12/16, S](#)

English

CAD Files

[3D PDF](#)

3D

Customer View Model

[ENG_CVM_CVM_YHD36-24-91SE00000_B.2d_dxf.zip](#)

English

Customer View Model

[ENG_CVM_CVM_YHD36-24-91SE00000_B.3d_igs.zip](#)

English

Customer View Model

[ENG_CVM_CVM_YHD36-24-91SE00000_B.3d_stp.zip](#)

English

By downloading the CAD file I accept and agree to the [Terms and Conditions](#) of use.

Product Specifications

[Engineering Report](#)

English