



CGS | CGS SM

TE Internal #: 6-1879234-9

360K Ω , Metal Film, Power Resistor, 5 %, 2 Termination, Taped & Reeled, 5 W, ± 100 ppm/ $^{\circ}\text{C}$, Solder, Height .268 in [6.8 mm], CGS SM

[View on TE.com >](#)

Passive Components > Resistors > Surface Mount Resistors > SMD Power Resistor: 7 Watt, 200-2M Ohm



Resistor Type: **Power Resistor**

Number of Terminations: **2**

Packaging Method: **Taped & Reeled**

Passive Component Tolerance: **5 %**

Element Type: **Metal Film**

[All SMD Power Resistor: 7 Watt, 200-2M Ohm \(316\)](#)

Features

Product Type Features

Resistor Type	Power Resistor
Element Type	Metal Film

Configuration Features

Number of Resistors	1
---------------------	---

Electrical Characteristics

Operating Voltage	500 V
Passive Component Tolerance	5 %
Resistance Class	1k Ω – 1M Ω
Resistance Value	360K Ω
Power Rating	5 W

Termination Features

Number of Terminations	2
Surface Mount Resistor Termination Type	Solder

Dimensions

Product Height	6.8 mm[.268 in]
Product Length	13.5 mm[.531 in]

Product Width	7.3 mm [.287 in]
---------------	------------------

Usage Conditions

Temperature Coefficient	± 100 ppm/ $^{\circ}\text{C}$
-------------------------	-----------------------------------

Packaging Features

Packaging Method	Taped & Reeled
------------------	----------------

Product Compliance

[For compliance documentation, visit the product page on TE.com>](#)

EU RoHS Directive 2011/65/EU	Compliant
EU ELV Directive 2000/53/EC	Compliant
China RoHS 2 Directive MIIT Order No 32, 2016	No Restricted Materials Above Threshold
EU REACH Regulation (EC) No. 1907/2006	Current ECHA Candidate List: JUNE 2023 (235) Candidate List Declared Against: JUNE 2023 (235) Does not contain REACH SVHC
Halogen Content	Low Halogen - Br, Cl, F, I < 900 ppm per homogenous material. Also BFR/CFR/PVC Free
Solder Process Capability	Wave solder capable to 265 $^{\circ}\text{C}$

Product Compliance Disclaimer

This information is provided based on reasonable inquiry of our suppliers and represents our current actual knowledge based on the information they provided. This information is subject to change. The part numbers that TE has identified as EU RoHS compliant have a maximum concentration of 0.1% by weight in homogenous materials for lead, hexavalent chromium, mercury, PBB, PBDE, DBP, BBP, DEHP, DIBP, and 0.01% for cadmium, or qualify for an exemption to these limits as defined in the Annexes of Directive 2011/65/EU (RoHS2). Finished electrical and electronic equipment products will be CE marked as required by Directive 2011/65/EU. Components may not be CE marked. Additionally, the part numbers that TE has identified as EU ELV compliant have a maximum concentration of 0.1% by weight in homogenous materials for lead, hexavalent chromium, and mercury, and 0.01% for cadmium, or qualify for an exemption to these limits as defined in the Annexes of Directive 2000/53/EC (ELV). Regarding the REACH Regulation, the information TE provides on SVHC in articles for this part number is based on the latest European Chemicals Agency (ECHA) 'Guidance on requirements for substances in articles' posted at this URL: <https://echa.europa.eu/guidance-documents/guidance-on-reach>

Compatible Parts



Also in the Series | **CGS SM**

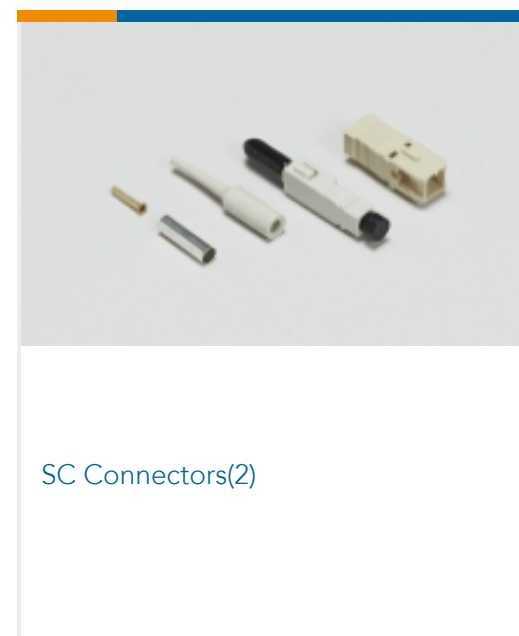
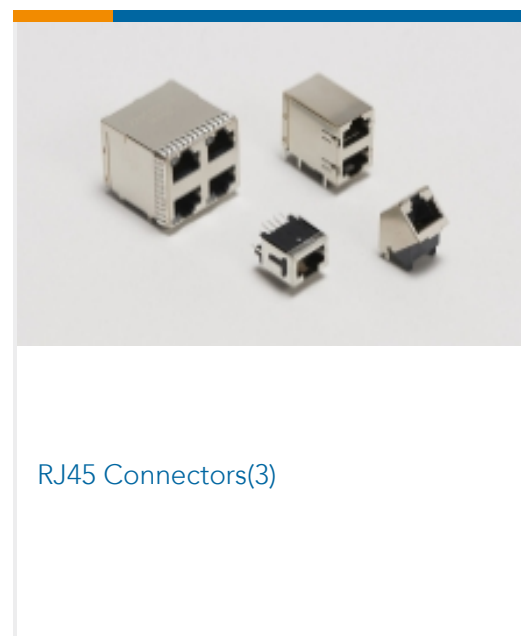
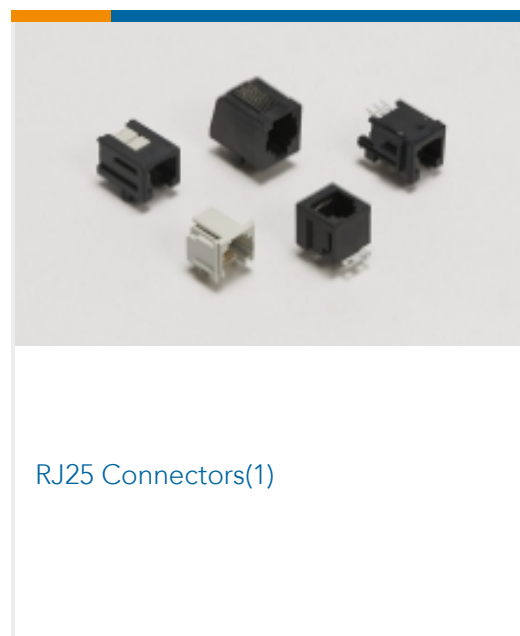
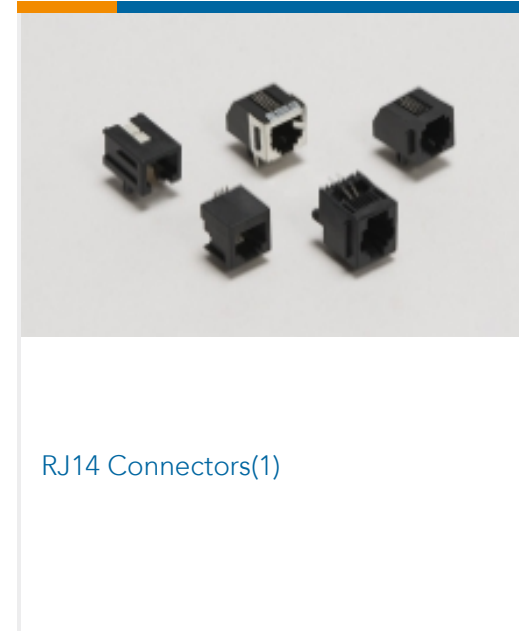
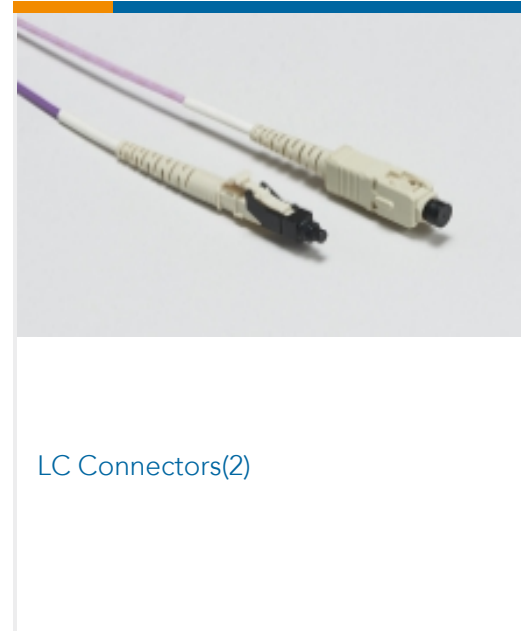
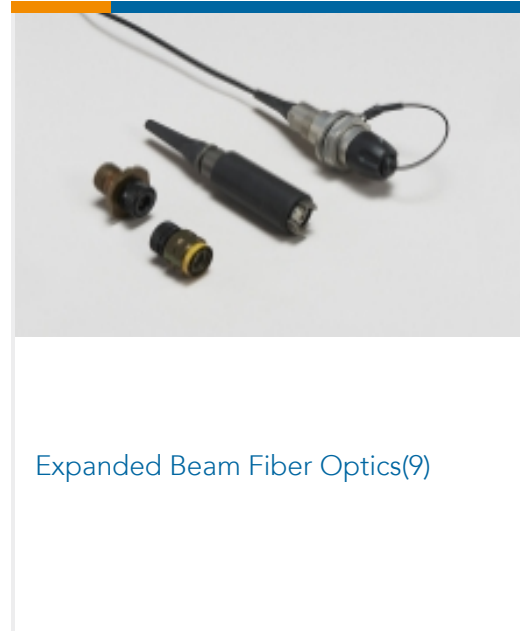
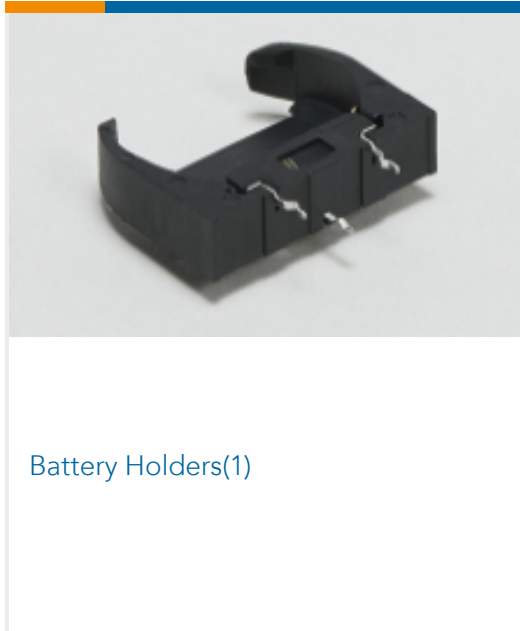

Customers Also Bought

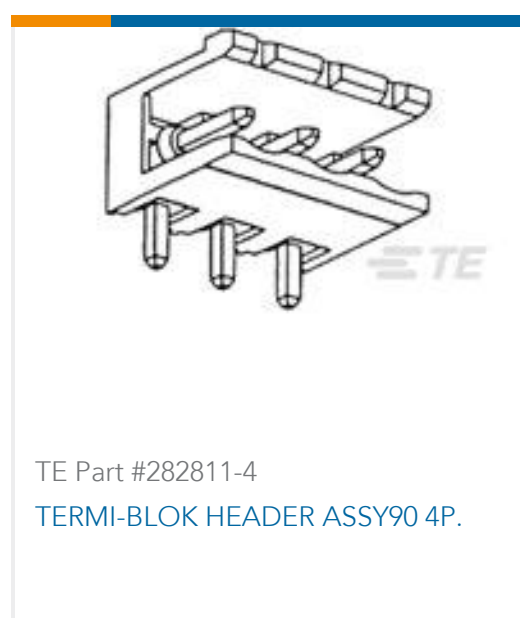



Documents

CAD Files

[3D PDF](#)

3D

Customer View Model

[ENG_CVM_CVM_6-1879234-9_BA.2d_dxf.zip](#)

English

Customer View Model

[ENG_CVM_CVM_6-1879234-9_BA.3d_igs.zip](#)

English

Customer View Model

[ENG_CVM_CVM_6-1879234-9_BA.3d_stp.zip](#)

English

By downloading the CAD file I accept and agree to the [Terms and Conditions](#) of use.

Datasheets & Catalog Pages

[1309350_PASSIVE_COMPONENT](#)

English

[SMD Moulded Power Resistor - Type SM Series - Tyco Electronics Passives](#)

English

[8-1773459-4_POWER_FILTERING_AND_RESISTIVE_SOLUTIONS_FOR_ELEVATORS_AND_ESCALATORS](#)

English