

2345390-1 ✓ ACTIVE

AMP | Superseal Pro

TE Internal #: 2345390-1

Receptacle, Cable-to-Cable, 3 Position, Sealable, Black, Wire & Cable, Power & Signal, Cable Mount (Free-Hanging), Superseal Pro

[View on TE.com >](#)



Connectors > Automotive Connectors > Automotive Housings



Connector System: **Cable-to-Cable**

Number of Positions: **3**

Connector & Housing Type: **Receptacle**

Sealable: **Yes**

Mating Tab Width: **2.8 mm [.109 in]**

Features

Product Type Features

Mixed & Hybrid Connector	No
Connector Shape	Rectangular
Connector System	Cable-to-Cable
Connector & Housing Type	Receptacle
Sealable	Yes
Connector & Contact Terminates To	Wire & Cable
Primary Locking Feature	Locking Lance

Configuration Features

Number of Positions	3
Number of Rows	1

Electrical Characteristics

Nominal Voltage Architecture	50 V
------------------------------	------

Body Features

Primary Product Color	Black
-----------------------	-------



Connector & Keying Code |

Contact Features

Contact Size	2.8mm
Mating Tab Width	2.8 mm[.109 in]
Mating Pin Diameter	5 mm[.196 in]

Mechanical Attachment

Mating Alignment Type	Keyed
Mating Alignment	With
Connector Mounting Type	Cable Mount (Free-Hanging)

Usage Conditions

Operating Temperature (Max)	120 °C[248 °F]
Operating Temperature Range	-40 – 120 °C[-40 – 248 °F]

Operation/Application

Circuit Application	Power & Signal
---------------------	----------------

Other

Connector Position Assurance Capable	Yes
--------------------------------------	-----

Product Compliance

[For compliance documentation, visit the product page on TE.com>](#)

EU RoHS Directive 2011/65/EU	Compliant
EU ELV Directive 2000/53/EC	Compliant
China RoHS 2 Directive MIIT Order No 32, 2016	No Restricted Materials Above Threshold
EU REACH Regulation (EC) No. 1907/2006	Current ECHA Candidate List: JUNE 2023 (235) Candidate List Declared Against: JUNE 2023 (235) Does not contain REACH SVHC
Halogen Content	BFR/CFR/PVC Free, but Br/Cl >900 ppm in other sources.
Solder Process Capability	Not reviewed for solder process capability

Product Compliance Disclaimer

This information is provided based on reasonable inquiry of our suppliers and represents our current actual knowledge based on the information they provided. This information is subject to change. The part numbers that TE has identified as EU RoHS compliant have a maximum concentration of 0.1% by weight in homogenous materials for lead, hexavalent chromium, mercury, PBB, PBDE, DBP, BBP, DEHP, DIBP, and 0.01% for cadmium, or qualify for an exemption to these limits as defined in the Annexes of Directive 2011/65/EU (RoHS2). Finished electrical and electronic equipment products

will be CE marked as required by Directive 2011/65/EU. Components may not be CE marked. Additionally, the part numbers that TE has identified as EU ELV compliant have a maximum concentration of 0.1% by weight in homogenous materials for lead, hexavalent chromium, and mercury, and 0.01% for cadmium, or qualify for an exemption to these limits as defined in the Annexes of Directive 2000/53/EC (ELV). Regarding the REACH Regulation, the information TE provides on SVHC in articles for this part number is based on the latest European Chemicals Agency (ECHA) 'Guidance on requirements for substances in articles' posted at this URL: <https://echa.europa.eu/guidance-documents/guidance-on-reach>

Compatible Parts



TE Part # 2050832-2
COVER FOR 3P SENSOR CONNECTOR



TE Part # 2050832-1
COVER FOR 3P SENSOR CONNECTOR

Also in the Series | Superseal Pro



Automotive Housings(87)



Connector Backshells(14)



Connector Caps & Covers(1)

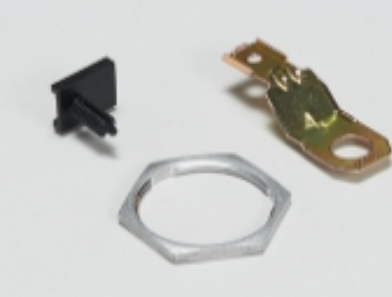

Other Automotive Connector Accessories(1)

Customers Also Bought



TE Part #1743354-2
MT-II/JPT SLD 16P CAP HSG

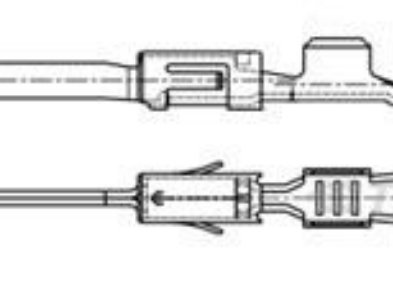

TE Part #963898-1
MICRO TIM ST1,6X0,6



TE Part #1241608-6
MQS1,5 Ag rec CB unseal. 0,75-1,5



TE Part #1743064-2
MT-2/JPT SLD 36P PLUG COVER BK



TE Part #2822365-2
EJ-2 DBL LOCK PLUG 2P ASSY D GRAY



TE Part #936429-2
HYBRID 42P CAP ASSY BLK



TE Part #1743059-2
MT-II/JPT SLD 36P PLUG ASSY



TE Part #2345390-2
3POS,AMP MCP 2.8,REC HSG ASSY, SLD,COD 2

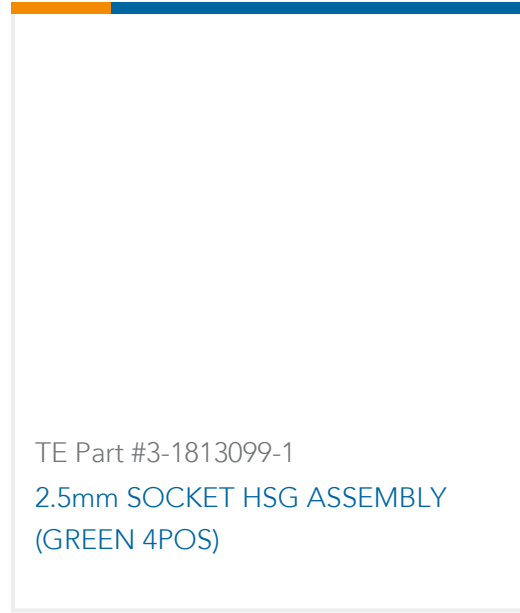

Documents

Product Drawings

[3POS,AMP MCP 2.8,REC HSG ASSY,SLD,COD 1](#)

English

CAD Files

[3D PDF](#)

3D

Customer View Model

[ENG_CVM_CVM_2345390-1_B.2d_dxf.zip](#)

English

Customer View Model

[ENG_CVM_CVM_2345390-1_B.3d_igs.zip](#)

English

Customer View Model

[ENG_CVM_CVM_2345390-1_B.3d_stp.zip](#)

English

By downloading the CAD file I accept and agree to the [Terms and Conditions](#) of use.

Product Specifications

[Product Specification](#)

English