

2388278-6 ✓ ACTIVE

AMP | Heavy Duty Sealed Connector Series

TE Internal #: 2388278-6

Other Automotive Connector Accessories, Mounting Clips, PA6 GF, Gray, -40 – 140 °C [-40 – 140 °F]

[View on TE.com >](#)



Connectors > Automotive Connectors > Automotive Connector Accessories > Other Automotive Connector Accessories >

Heavy Duty Sealed Connector Series Fixing Slides



Automotive Connector Accessory Type: **Mounting Clips**

Primary Product Material: **PA6 GF**

Primary Product Color: **Gray**

Operating Temperature Range: **-40 – 140 °C [-40 – 140 °F]**

[All Heavy Duty Sealed Connector Series Fixing Slides \(33\)](#)

## Features

### Product Type Features

Automotive Connector Accessory Type	Mounting Clips
-------------------------------------	----------------

### Body Features

Primary Product Material	PA6 GF
--------------------------	--------

Primary Product Color	Gray
-----------------------	------

### Usage Conditions

Operating Temperature Range	-40 – 140 °C[-40 – 140 °F]
-----------------------------	----------------------------

### Industry Standards

UL Flammability Rating	UL 94V-0
------------------------	----------

## Product Compliance

[For compliance documentation, visit the product page on TE.com>](#)

EU RoHS Directive 2011/65/EU	Compliant
------------------------------	-----------

EU ELV Directive 2000/53/EC	Compliant
-----------------------------	-----------



China RoHS 2 Directive MIIT Order No 32, 2016	No Restricted Materials Above Threshold
EU REACH Regulation (EC) No. 1907/2006	Current ECHA Candidate List: JUNE 2023 (235) Candidate List Declared Against: JUNE 2023 (235) Does not contain REACH SVHC
Halogen Content	Low Halogen - Br, Cl, F, I < 900 ppm per homogenous material. Also BFR/CFR/PVC Free
Solder Process Capability	Not reviewed for solder process capability

Product Compliance Disclaimer

This information is provided based on reasonable inquiry of our suppliers and represents our current actual knowledge based on the information they provided. This information is subject to change. The part numbers that TE has identified as EU RoHS compliant have a maximum concentration of 0.1% by weight in homogenous materials for lead, hexavalent chromium, mercury, PBB, PBDE, DBP, BBP, DEHP, DIBP, and 0.01% for cadmium, or qualify for an exemption to these limits as defined in the Annexes of Directive 2011/65/EU (RoHS2). Finished electrical and electronic equipment products will be CE marked as required by Directive 2011/65/EU. Components may not be CE marked. Additionally, the part numbers that TE has identified as EU ELV compliant have a maximum concentration of 0.1% by weight in homogenous materials for lead, hexavalent chromium, and mercury, and 0.01% for cadmium, or qualify for an exemption to these limits as defined in the Annexes of Directive 2000/53/EC (ELV). Regarding the REACH Regulation, the information TE provides on SVHC in articles for this part number is based on the latest European Chemicals Agency (ECHA) 'Guidance on requirements for substances in articles' posted at this URL: <https://echa.europa.eu/guidance-documents/guidance-on-reach>

## Compatible Parts



## Also in the Series | Heavy Duty Sealed Connector Series

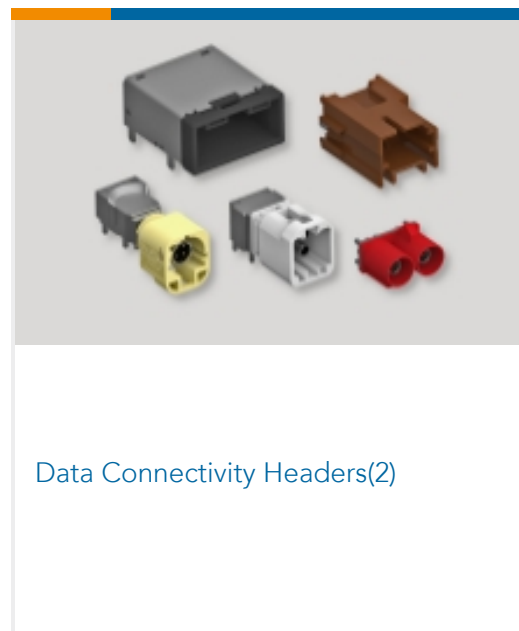
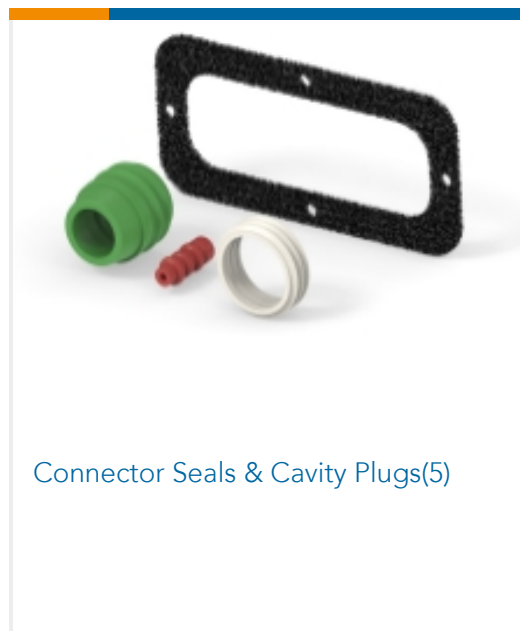
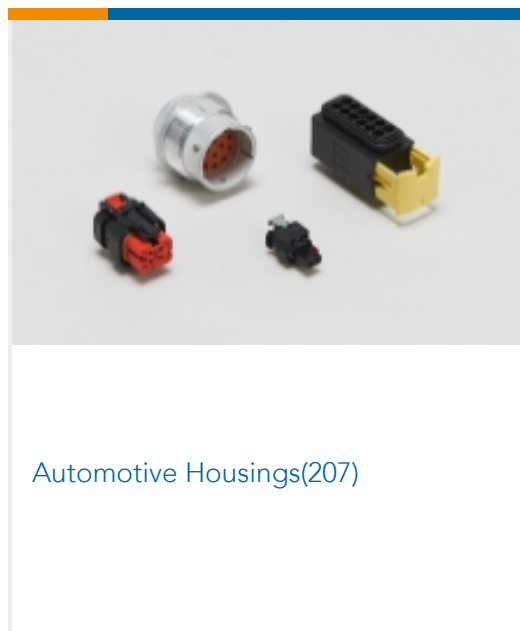
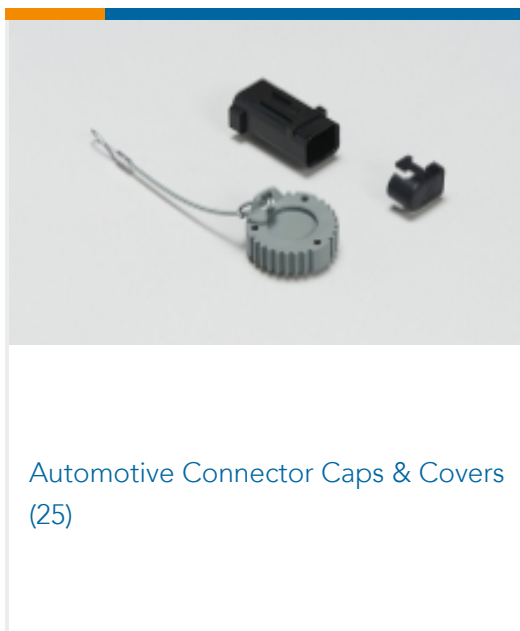



Data Connectivity Housings(18)



Other Automotive Connector Accessories(34)

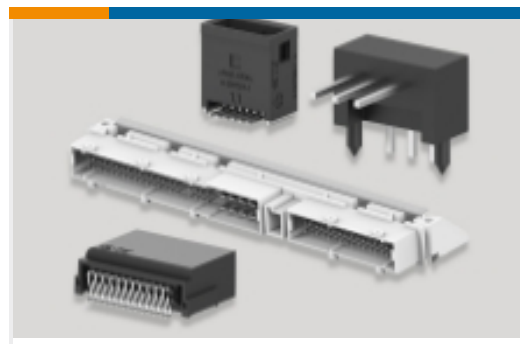

PCB Headers & Receptacles(1)

## Customers Also Bought



TE Part #493487-1  
HSG 8 POSN. MICROTIMER REC.

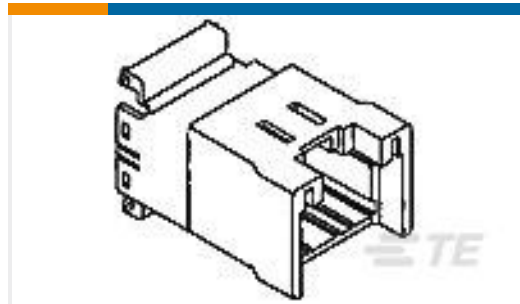

TE Part #174058-4  
040 MLC CAP HSG 12P GREEN

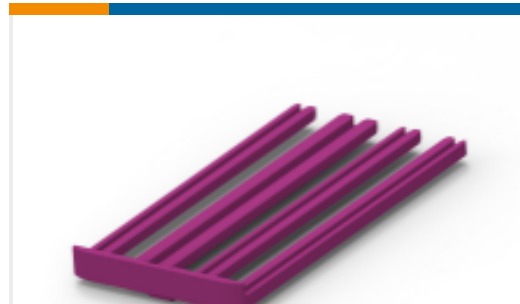

TE Part #2208714-2  
2. LOCK,MCON1,2 CB



TE Part #282480-1  
DOOR TO BOPDY F



TE Part #9-2208716-9  
PLATE,FAMILY SEAL COVER,91POS



TE Part #3-1813099-2  
2.5mm SOCKET HSG ASSEMBLY (GREEN 3POS)



TE Part #5-2436557-1  
SWS,AMP MCP 2.8,CVTY DIA,5.2,BLU



TE Part #2435187-3  
JPT,TERMINAL,REC 2.8 SRC SN



TE Part #2438861-1  
DIA 2.5MM,TERMINAL



TE Part #2435179-1  
JPT,TERMINAL,REC 2.8 CONTACT SWS SN

## Documents

### Product Drawings

[SLIDE,TAB HSG ASSY,GROUP D](#)

English

### CAD Files

[3D PDF](#)

3D

[Customer View Model](#)

[ENG\\_CVM\\_CVM\\_2388278-6\\_A.2d\\_dxf.zip](#)



English

Customer View Model

[ENG\\_CVM\\_CVM\\_2388278-6\\_A.3d\\_igs.zip](#)

English

Customer View Model

[ENG\\_CVM\\_CVM\\_2388278-6\\_A.3d\\_stp.zip](#)

English

By downloading the CAD file I accept and agree to the [Terms and Conditions](#) of use.

**Product Specifications**

[Application Specification](#)

English