

HDP26-24-23SE-L024 ✓ ACTIVE

DEUTSCH | DEUTSCH HD, DEUTSCH HDP

TE Internal #: YHDP26-24-23SEL024

Housing for Female Terminals, Wire-to-Wire, 23 Position, Sealable, Black, Wire & Cable, Power & Signal, Cable Mount (Free-Hanging), Hybrid

[View on TE.com >](#)



Connectors > Automotive Connectors > Automotive Housings > DEUTSCH HDP20 Housings



Connector System: **Wire-to-Wire**

Number of Positions: **23**

Connector & Housing Type: **Housing for Female Terminals**

Sealable: **Yes**

Mating Pin Diameter: **1.59 mm [.063 in]**

[All DEUTSCH HDP20 Housings \(324\)](#)

Features

Product Type Features

Mixed & Hybrid Connector	No
Connector Shape	Circular
Connector System	Wire-to-Wire
Connector & Housing Type	Housing for Female Terminals
Sealable	Yes
Connector & Contact Terminates To	Wire & Cable
Primary Locking Feature	Contact Retainer

Configuration Features

Blank Cavity Position	0
Connector Modification	Wide Threaded Adapter
Connector Seal Code	E Seal
Number of Positions	23



Electrical Characteristics

Operating Voltage	250 VAC
Nominal Voltage Architecture	12 V, 24 V, 48 V

Body Features

Cable Exit Angle	180°
Primary Product Color	Black

Contact Features

Contact Size	Size 16, Size 20
Contact Type	Socket
Mating Pin Diameter	1.59 mm[.063 in]
Contact Current Rating (Max)	13 A

Mechanical Attachment

Terminal Position Assurance	No
Strain Relief	Add By Accessory
Mating Alignment Type	Guide Slot
Mating Alignment	With
Connector Mounting Type	Cable Mount (Free-Hanging)

Housing Features

Housing Material	PA GF
------------------	-------

Dimensions

Connector Height	49.53 mm[1.95 in]
Product Width	49.53 mm[1.95 in]
Product Length	38.3 mm[1.508 in]
Compatible Insulation Diameter Range	1.35 – 3.05 mm[.053 – .12 in]

Usage Conditions

Operating Temperature (Max)	125 °C[257 °F]
Operating Temperature Range	-55 – 125 °C[-67 – 257 °F]

Operation/Application

Circuit Application	Power & Signal
---------------------	----------------

Industry Standards

Degree of Protection	IP67
UL Flammability Rating	20mm Flame Test per Standard UL-94



Packaging Features

Packaging Quantity	1
Packaging Method	Box

Other

Serviceable	Yes
Connector Position Assurance Capable	No

Product Compliance

[For compliance documentation, visit the product page on TE.com>](#)

EU RoHS Directive 2011/65/EU	Compliant
EU ELV Directive 2000/53/EC	Compliant
China RoHS 2 Directive MIIT Order No 32, 2016	No Restricted Materials Above Threshold
EU REACH Regulation (EC) No. 1907/2006	Current ECHA Candidate List: JUNE 2023 (235) Candidate List Declared Against: JUNE 2023 (235) Does not contain REACH SVHC
Halogen Content	Not Low Halogen - contains Br or Cl > 900 ppm.
Solder Process Capability	Not reviewed for solder process capability

Product Compliance Disclaimer

This information is provided based on reasonable inquiry of our suppliers and represents our current actual knowledge based on the information they provided. This information is subject to change. The part numbers that TE has identified as EU RoHS compliant have a maximum concentration of 0.1% by weight in homogenous materials for lead, hexavalent chromium, mercury, PBB, PBDE, DBP, BBP, DEHP, DIBP, and 0.01% for cadmium, or qualify for an exemption to these limits as defined in the Annexes of Directive 2011/65/EU (RoHS2). Finished electrical and electronic equipment products will be CE marked as required by Directive 2011/65/EU. Components may not be CE marked. Additionally, the part numbers that TE has identified as EU ELV compliant have a maximum concentration of 0.1% by weight in homogenous materials for lead, hexavalent chromium, and mercury, and 0.01% for cadmium, or qualify for an exemption to these limits as defined in the Annexes of Directive 2000/53/EC (ELV). Regarding the REACH Regulation, the information TE provides on SVHC in articles for this part number is based on the latest European Chemicals Agency (ECHA) 'Guidance on requirements for substances in articles' posted at this URL: <https://echa.europa.eu/guidance-documents/guidance-on-reach>

Compatible Parts



Also in the Series | **DEUTSCH HD**

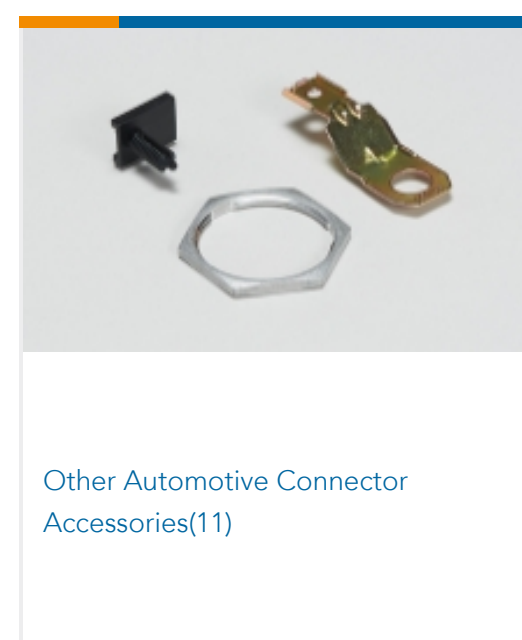
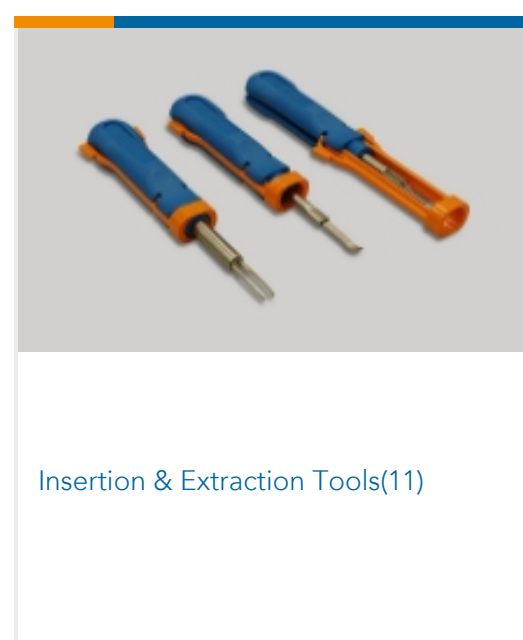
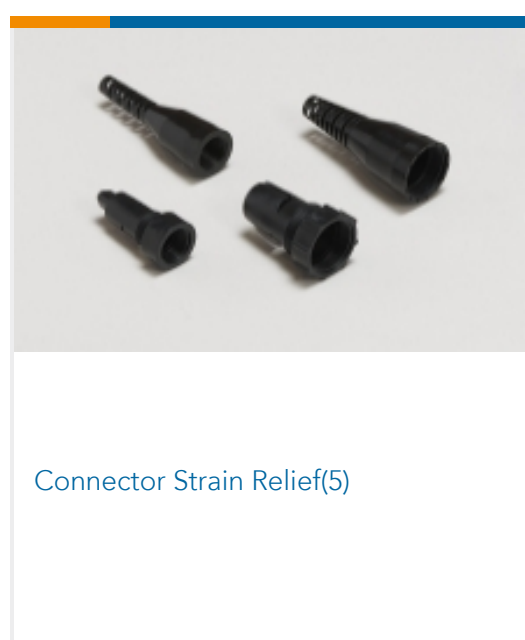
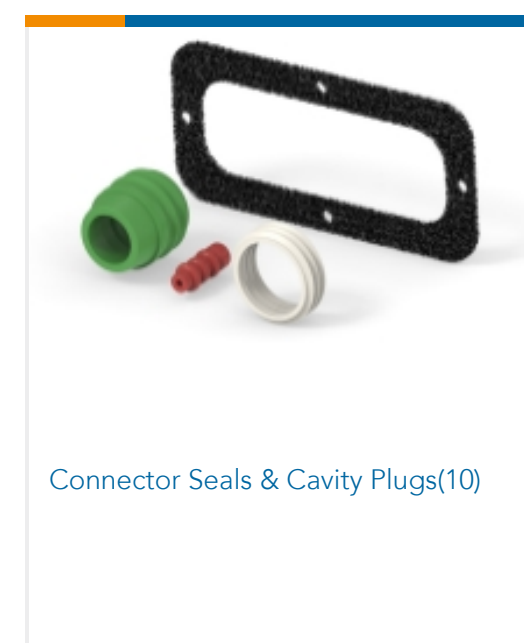
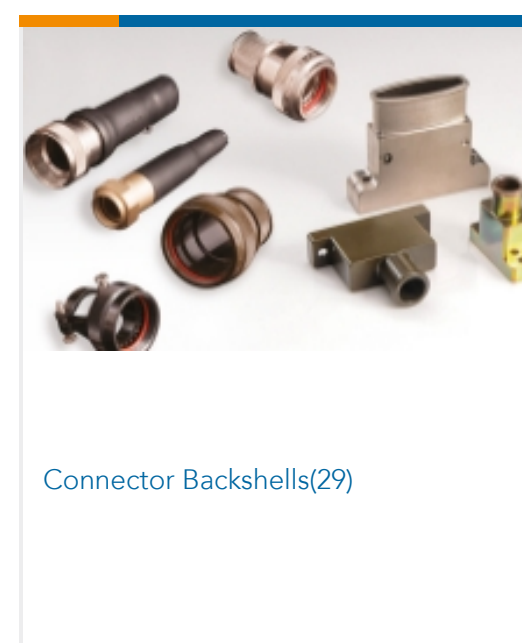
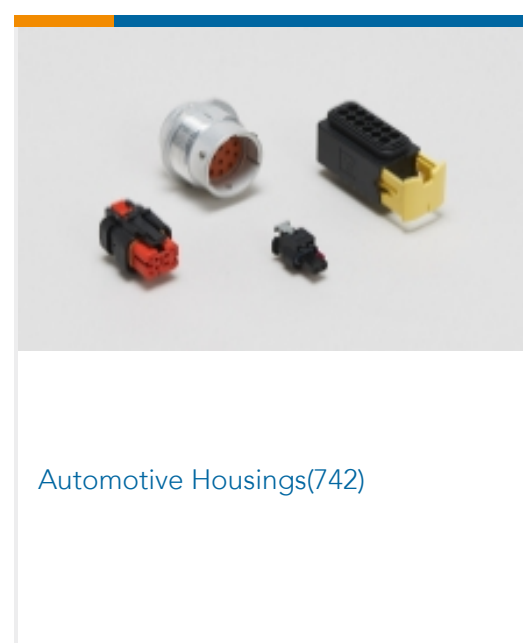
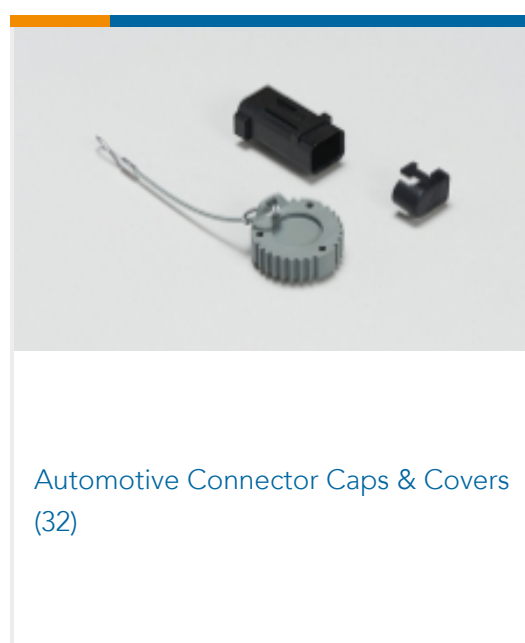

Also in the Series | **DEUTSCH HDP**



Automotive Connector Caps & Covers (4)



Automotive Housings(331)



Connector Backshells(8)



Connector Seals & Cavity Plugs(1)



Insertion & Extraction Tools(11)



Other Automotive Connector Accessories(5)

Customers Also Bought



TE Part #DT04-12PA-BL08
DEUTSCH DT Receptacle Connectors



TE Part #0528-005-3805
BKSHL, 38P, BLK, PLG, RA, LOW PROFILE

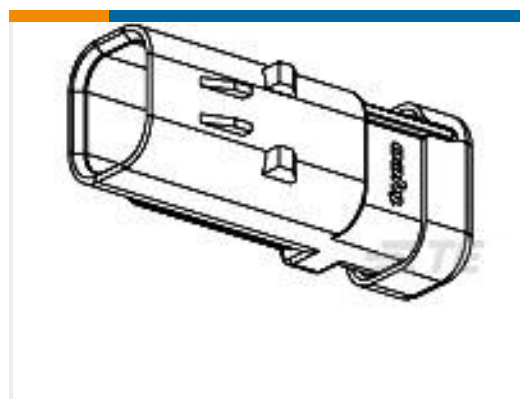

TE Part #776428-4
AS 16, 2P CAP ASSY, KEY 4



TE Part #HDP26-18-8SE-L017
DEUTSCH HDP20 Housings

Documents

Product Drawings

PLG, 23P, BLK, E, WTHD, 16, S

English

CAD Files

3D PDF

3D

Customer View Model

[ENG_CVM_CVM_YHDP26-24-23SEL024_B.2d_dxf.zip](#)

English

Customer View Model

[ENG_CVM_CVM_YHDP26-24-23SEL024_B.3d_igs.zip](#)

English

Customer View Model

[ENG_CVM_CVM_YHDP26-24-23SEL024_B.3d_stp.zip](#)

English

By downloading the CAD file I accept and agree to the [Terms and Conditions](#) of use.



Datasheets & Catalog Pages

[ICT Terminals and Connectors Catalogue](#)

English

[CONNECTOR SELECTOR](#)

English

Product Specifications

[Application Specification](#)

English

Agency Approvals

[UL Report](#)

English