

RQ73C1E102RBTD

✓ ACTIVE

Holsworthy | Holsworthy RQ73

TE Internal #: 4-2176362-0

102 Ω , Thin Film, Precision Resistor, .1 %, 2 Termination, 0402, Taped & Reeled, .0625 W, ± 10 ppm/ $^{\circ}\text{C}$, Solder, Height .012 in [.3 mm], Holsworthy RQ73

[View on TE.com >](#)



Passive Components > Resistors > Surface Mount Resistors



Resistor Type: **Precision Resistor**

Number of Terminations: **2**

Package Size Code: **0402**

Packaging Method: **Taped & Reeled**

Passive Component Tolerance: **.1 %**

Features

Product Type Features

Resistor Type	Precision Resistor
Package Size Code	0402
Element Type	Thin Film

Configuration Features

Number of Resistors	1
---------------------	---

Electrical Characteristics

Operating Voltage	50 V
Passive Component Tolerance	.1 %
Resistance Class	Up to 1k Ω
Resistance Value	102 Ω
Power Rating	.0625 W

Termination Features

Number of Terminations	2
Surface Mount Resistor Termination Type	Solder



Dimensions

Product Height	.3 mm[.012 in]
Product Length	1 mm[.039 in]
Product Width	.5 mm[.02 in]

Usage Conditions

Temperature Coefficient	± 10 ppm/ $^{\circ}$ C
-------------------------	----------------------------

Packaging Features

Packaging Method	Taped & Reeled
------------------	----------------

Product Compliance

[For compliance documentation, visit the product page on TE.com>](#)

EU RoHS Directive 2011/65/EU	Compliant
EU ELV Directive 2000/53/EC	Compliant
China RoHS 2 Directive MIIT Order No 32, 2016	No Restricted Materials Above Threshold
EU REACH Regulation (EC) No. 1907/2006	Current ECHA Candidate List: JUNE 2023 (235) Candidate List Declared Against: JUNE 2023 (235) Does not contain REACH SVHC
Halogen Content	Low Halogen - Br, Cl, F, I < 900 ppm per homogenous material. Also BFR/CFR/PVC Free
Solder Process Capability	Reflow solder capable to 260 $^{\circ}$ C

Product Compliance Disclaimer

This information is provided based on reasonable inquiry of our suppliers and represents our current actual knowledge based on the information they provided. This information is subject to change. The part numbers that TE has identified as EU RoHS compliant have a maximum concentration of 0.1% by weight in homogenous materials for lead, hexavalent chromium, mercury, PBB, PBDE, DBP, BBP, DEHP, DIBP, and 0.01% for cadmium, or qualify for an exemption to these limits as defined in the Annexes of Directive 2011/65/EU (RoHS2). Finished electrical and electronic equipment products will be CE marked as required by Directive 2011/65/EU. Components may not be CE marked. Additionally, the part numbers that TE has identified as EU ELV compliant have a maximum concentration of 0.1% by weight in homogenous materials for lead, hexavalent chromium, and mercury, and 0.01% for cadmium, or qualify for an exemption to these limits as defined in the Annexes of Directive 2000/53/EC (ELV). Regarding the REACH Regulation, the information TE provides on SVHC in articles for this part number is based on the latest European Chemicals Agency (ECHA) 'Guidance on requirements for substances in articles' posted at this URL: <https://echa.europa.eu/guidance-documents/guidance-on-reach>

Compatible Parts



TE Part # 2176372-6
RQ 0603 56K2 0.1% 10PPM 5K RL



TE Part # 2176371-8
RQ 0603 5K49 0.1% 10PPM 5K RL



TE Part # 3-2176382-0
RQ 0805 267K 0.1% 10PPM 5K RL



TE Part # 3-2176389-4
RQ 1206 237R 0.1% 10PPM 5K RL



TE Part # 4-2176391-2
RQ 1206 33K2 0.1% 10PPM 5K RL



TE Part # 4-2176359-0
RQ 0402 102R 0.1% 10PPM 1K RL

Also in the Series | **Holsworthy RQ73**



Surface Mount Resistors(3078)

Customers Also Bought



TE Part #DT04-2P
REC, 2P, GRY, N



TE Part #DT06-2S
PLG, 2P, GRY, N



TE Part #W2S
Wedgelocks: DEUTSCH DT



TE Part #0462-201-16141
DEUTSCH Solid Contacts



TE Part #282104-1
AMP SUPERSEAL 1.5MM,
CONNECTOR HOUSING

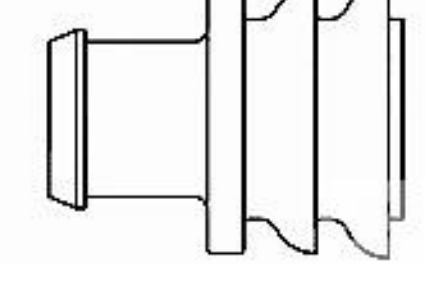

TE Part #281934-2
SINGLE WIRE SEAL



TE Part #114017-ZZ
SEALING PLUG, SIZE 12/16, WHT



Documents

Product Drawings

[RQ 0402 102R 0.1% 10PPM 5K RL](#)

English

CAD Files

[3D PDF](#)

3D

Customer View Model

[ENG_CVM_CVM_4-2176362-0_B.2d_dxf.zip](#)

English

Customer View Model

[ENG_CVM_CVM_4-2176362-0_B.3d_igs.zip](#)

English

Customer View Model

[ENG_CVM_CVM_4-2176362-0_B.3d_stp.zip](#)

English

By downloading the CAD file I accept and agree to the [Terms and Conditions](#) of use.