

DCF安规瓷介电容器(Y2)

DCF Safety Standard Recognized Ceramic Capacitors (Y2)

特性 Feature











- 容量范围 Wide capacitance range from 10pF to 10000pF
- 工作温度 Operating Temperature: -40℃~125℃
- 存储温度 Storage Temperature: -10℃~40℃

应用 Applications

安规瓷介电容器具有高介电系数的陶瓷介质和阻燃的环氧树脂封装，适用于电子设备的电源电路噪声抑制电路中，也可用作天线耦合跨接和旁路电路中。

The safety standard recognized ceramic capacitors have dielectric ceramics with high dielectric coefficient and encapsulation of flame retardant epoxy resin. These capacitors are used in noise suppression circuit of power supply circuit for general electronic equipments and may be used as antenna coupling, crossing and bypass circuit.

使用标准 Applicable Standard

通过认证 APPROVAL	认证组织 ORGANIZATION	标准 SAFTY STANDARDS	证书 CERTIFICATE NO.
	UL CUL	UL60384-14	E154899
	CSA	CAN/CSA-E60384-14	2405437
	(VDE+ENEC)VD E	IEC 60384 -14	40036246
	SEMKO	EN60384-14	1914801
	KTC	K60384 - 14	HU03004-10003D HU03004-10005D
	NEMKO	EN60384-14	P19223823
	DEMKO	EN60384-14	D-03468
	FIMKO	IEC 60384 -14	FI 40341
	SEV	IEC 60384 -14	22.0425
	CQC	IEC 60384 -14	CQC15001127382

产品型号 Part Number

DCF 221 K 22 Y5P Q 6 K H D ET

型号 Type:

DCF: 安规型瓷介电容器

电容量 (Capacitance):

470: 47pF

221: 220pF

472: 4700pF

103: 10000pF

电容量允许偏差

Capacitance Tolerance:

M=20%

Z=+80%-20%

K=±10%

J=±5%

尺寸代码 Size:

见规格详情

See the specification

温度特性

temperature characteristic:

Y5P, Y5U, Y5V, SL

额定电压 Rated voltage:

Q=X1 400VAC/Y2 250VAC G=X1 400VAC/Y1 250VAC

内部管理代码

Interior managing code

位引线间距 Lead spacing:

5=5.0mm D/7=7.5mm 0=10mm

引线式样 Lead style:

L、K、H、P

见引线形状 see the lead style

位引线长度/包装方法/

Lead length/package:

B=20mm min, M=2.1±0.5mm

K=2.8±0.5mm, J=3.2±0.5mm,

W=3.5±0.5mm, K=2.8±0.5mm,

F=12.7mm 编带/扇折, V=15.0mm 编带/扇折

引线直径 Lead diameter:

CP 线:

6=0.55±0.05mm 8=0.78±0.05mm

CU 线:

E=0.58±0.05mm D=0.780±0.05mm

脚型 Lead style

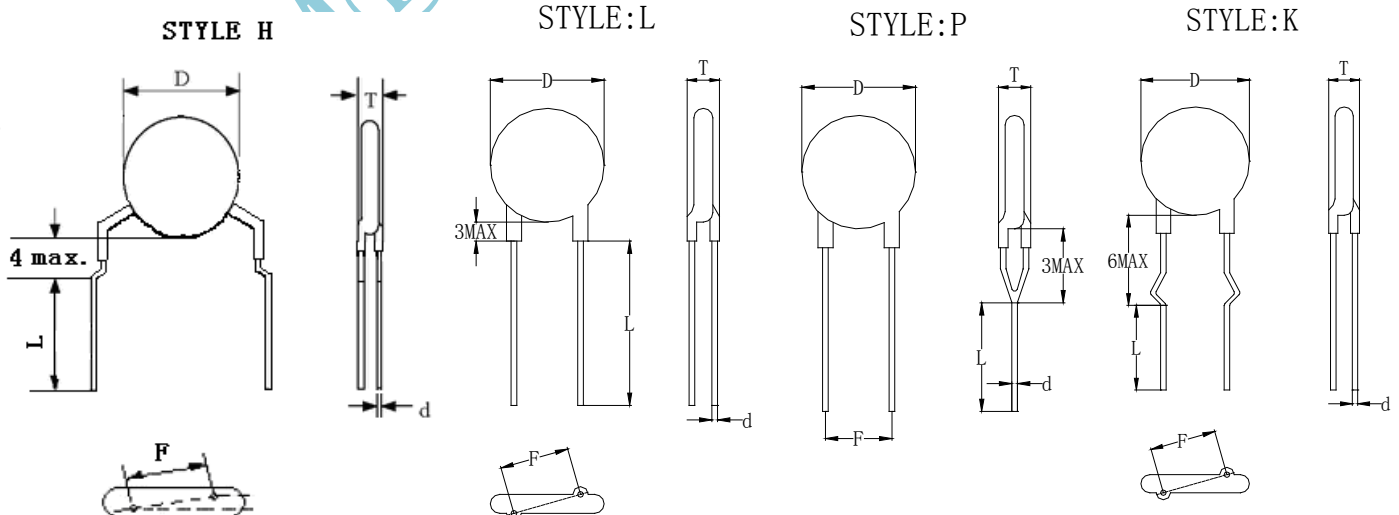

规格 Specification









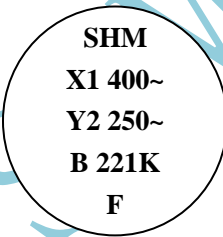

SHM 产品代码 SHM Part No.	额定电压 Rated voltage (VDC)	标称容量 Nominal capacitance (pF)	电容量允许偏差范围 Tolerance (%)	温度特性 Temperature Characteristic	产品尺寸(mm)				
					直径 Dmax. (mm)	厚度 Tmax (mm)	引线间距 F(mm)	引线直径 d (mm)	引线长度 L (mm)/编带方式
DCF221K22Y5PQ6KHDET	X1-400 Y2-250	220	±10%	Y5P	6.0	4.0	7.5±0.5	0.55±0.05	2.8±0.5
DCF331K26Y5PQ6MK7HR	X1-400 Y2-250	330	±10%	Y5P	6.8	5.0	7.5±0.5	0.55±0.05	2.0+0.5/-0.3
DCF471K30Y5PQ6WL7A0	X1-400 Y2-250	470	±10%	Y5P	7.8	5.0	7.5±0.5	0.55±0.05	3.5±0.5
DCF471K30Y5PQBWL7A0	X1-400 Y2-250	470	±10%	Y5P	7.8	5.0	7.5±0.5	0.55±0.05	3.5±0.5
DCF102M26Y5UQEWL7A0	X1-400 Y2-250	1000	±20%	Y5U	6.8	5.0	7.5±0.5	0.58±0.05	3.5±0.5
DCF102M30Y5UQ6VHDA0	X1-400 Y2-250	1000	±20%	Y5U	7.8	5.0	7.5±0.3	0.55±0.05	V1 编带
DCF152M30Y5UQ6WP7A0	X1-400 Y2-250	1500	±20%	Y5U	7.8	5.0	7.5±0.5	0.55±0.05	3.5±0.5
DCF222M34Y5UQBWL7A0	X1-400 Y2-250	2200	±20%	Y5U	9.0	5.0	7.5±0.5	0.55±0.05	3.5±0.5
DCF472M53Y5UQ6WP7A0	X1-400 Y2-250	4700	±20%	Y5U	14.0	5.0	7.5±0.5	0.55±0.05	3.5±0.5
DCF102M26Y5VQBK5BU	X1-400 Y2-250	1000	±20%	Y5V	6.8	5.0	7.5±0.5	0.55±0.05	F 编带
DCF102M26Y5VQEFK5A0	X1-400 Y2-250	1000	±20%	Y5V	6.8	5.0	7.5±0.5	0.58±0.05	F 编带
DCF222M30Y5VQ6JL7H1	X1-400 Y2-250	2200	±20%	Y5V	7.8	5.0	7.5±0.5	0.55±0.05	3.2±0.5
DCF222M30Y5VQ6VL0A0	X1-400 Y2-250	2200	±20%	Y5V	7.8	5.0	10.0±0.5	0.55±0.05	V2 编带
DCF222M30Y5VQ6WL7A0	X1-400 Y2-250	2200	±20%	Y5V	7.8	5.0	7.5±0.5	0.55±0.05	3.5±0.5

电性能指标 Electrical Performance

序号 No.	项目名称 Item	技术要求 Specification	
1	容量和误差 C	@25°C, 1kHz and 1Vrms	参照规格表 See the specification
2	损耗系数 DF		2.5% max. (Y5P, Y5U) 5.0% max. (Y5V)
3	绝缘电阻 IR	@500 VDC, 60S	10000MΩ min
4	耐电压 Rate Voltage	@2600VAC, 60S	无击穿或飞弧。 No visible damage
5	温度特性 temperature characteristic	Y5P	±10%
		Y5U	+22% to -56%
		Y5V	+22% to -82%

标志 Marking

例如 e.g

Y2 电容器	
正面 Front	 <p>SHM X1 400~ Y2 250~ B 221K F</p>
反面 Back	 <p>         </p>
丝印说明	
SHM	商标 Trademark
X1 400~	作 X1 电容用时的额定电压 400VAC
Y2 250~	作 Y2 电容用时的额定电压 250VAC
B	温度特性。B: Y5P, E: Y5U, F: Y5V
221	标称电容量
K	容量误差。J=5%, K=10%, M=20%
F	安规电容系列
背面标志	安规认证标志

TAPING STYLE F

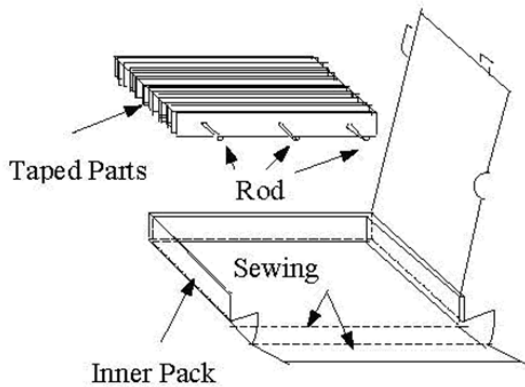
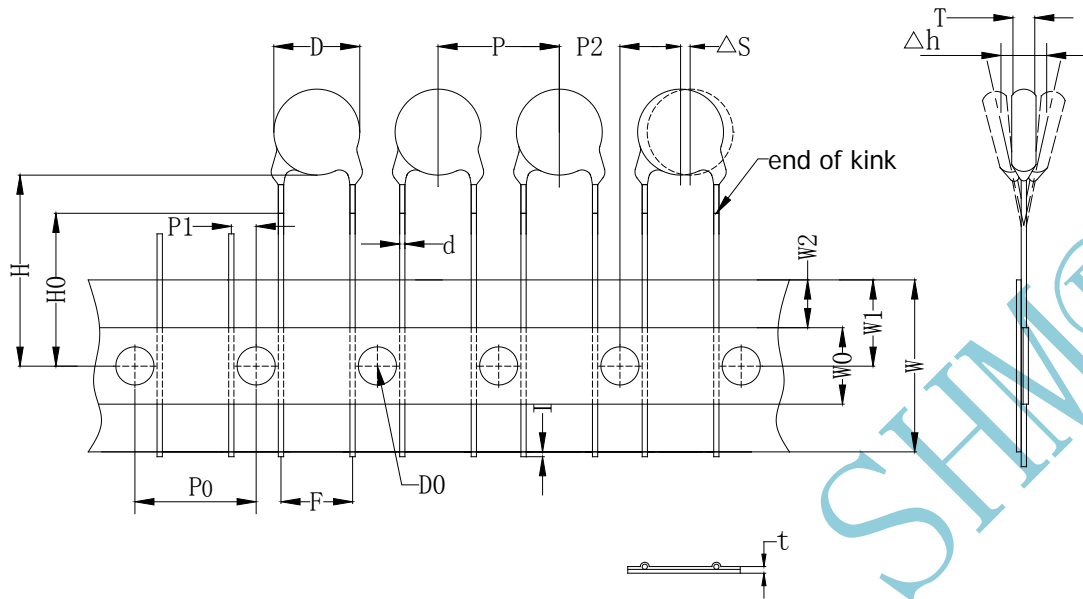

- 1.*打弯脚型以 H0 为准。
 For kink lead only.
 2.*直脚产品以 H 为准。
 For straight lead only.

Symbol	Dimension(mm)
P0	12.7±0.2
P	12.7±1.0
F	7.5±0.5
P1	2.6±0.4
P2	6.35±0.4
H0	16.0±1.0* ¹
H	20.0±1.0* ²
W	18.0±0.5
W0	8.0min.
W1	9.0±0.3
W2	3.0max.
t	0.7±0.2
D	To comply with individual sheet
D0	4.0±0.2
d	To comply with individual sheet
l	2.0max.
T	To comply with individual sheet
ΔS	1.0max.
Δh	1.0max.

TAPING STYLE V1

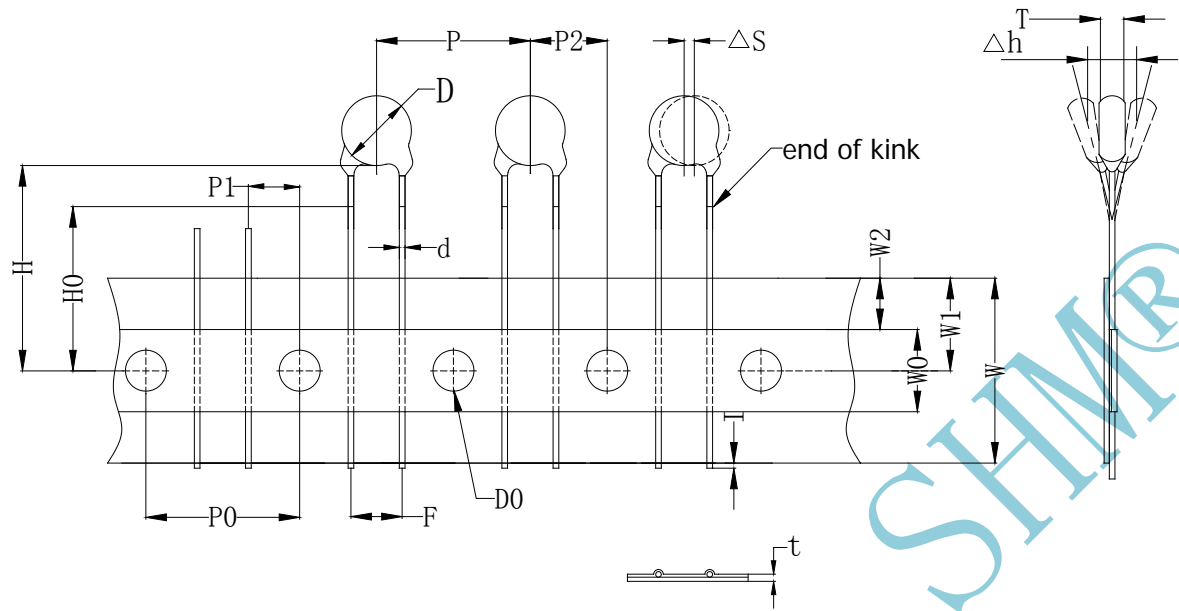

- 1.*打弯脚型以 H0 为准。
 For kink lead only.
 2.*直脚产品以 H 为准。
 For straight lead only.

Symbol	Dimension(mm)
P0	15.0±0.2
P	15.0±1.0
F	7.5±0.3
P1	3.75±0.4
P2	7.5±0.4
H0	16.0±1.0* ¹
H	20.0±1.0* ²
W	18.0±0.5
W0	8.0min.
W1	9.0±0.3
W2	3.0max.
t	0.7±0.2
D	To comply with individual sheet
D0	4.0±0.2
d	To comply with individual sheet
l	2.0max.
T	To comply with individual sheet
ΔS	1.0max.
Δh	1.0max.

TAPING STYLE V2

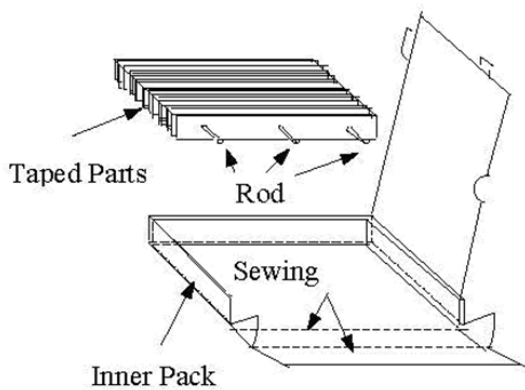
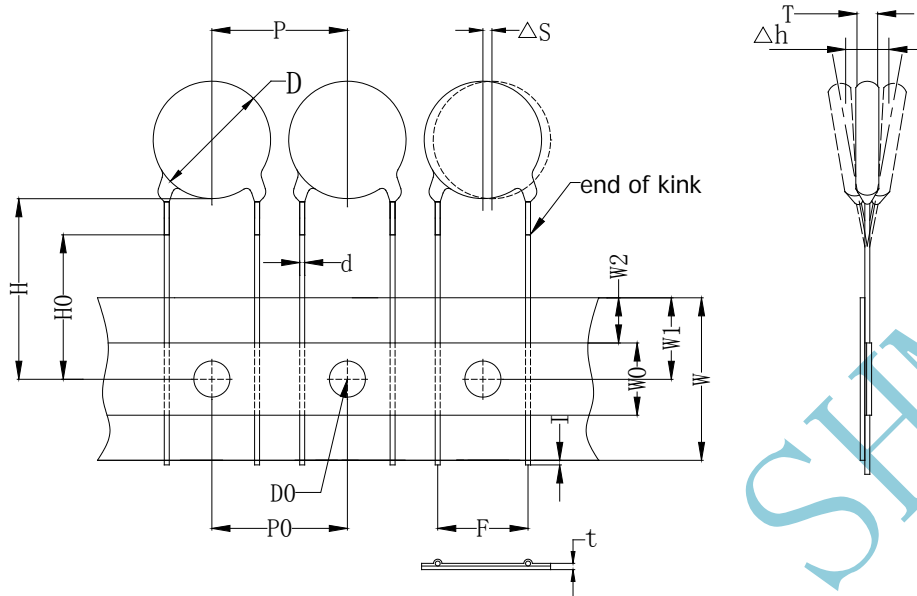

- 1.*打弯脚型以 H_0 为准。
For kink lead only.
2.*直脚产品以 H 为准。
For straight lead only.

Symbol	Dimension(mm)
P_0	15.0 ± 0.2
P	15.0 ± 1.0
F	10.0 ± 0.5
P_1	/
P_2	/
H_0	$16.0 \pm 1.0^{*1}$
H	$20.0 \pm 1.0^{*2}$
W	18.0 ± 0.5
W_0	8.0min.
W_1	9.0 ± 0.3
W_2	3.0max.
t	0.7 ± 0.2
D	To comply with individual sheet
D_0	4.0 ± 0.2
d	To comply with individual sheet
l	2.0max.
T	To comply with individual sheet
ΔS	1.0max.
Δh	1.0max.