

National Semiconductor is now part of  
Texas Instruments.

Search <http://www.ti.com/> for the latest technical  
information and details on our current products and services.

# LP2986

## Micropower, 200 mA Ultra Low-Dropout Fixed or Adjustable Voltage Regulator

### General Description

The LP2986 is a 200 mA precision LDO voltage regulator which offers the designer a higher performance version of the industry standard LP2951.

Using an optimized VIP™ (Vertically Integrated PNP) process, the LP2986 delivers superior performance:

**Dropout Voltage:** Typically 180 mV @ 200 mA load, and 1 mV @ 1 mA load.

**Ground Pin Current:** Typically 1 mA @ 200 mA load, and 200 µA @ 10 mA load.

**Sleep Mode:** The LP2986 draws less than 1 µA quiescent current when shutdown pin is pulled low.

**Error Flag:** The built-in error flag goes low when the output drops approximately 5% below nominal.

**Precision Output:** The standard product versions available can be pin-strapped (using the internal resistive divider) to provide output voltages of 5.0V, 3.3V, or 3.0V with guaranteed accuracy of 0.5% ("A" grade) and 1% (standard grade) at room temperature.

### Features

- Ultra low dropout voltage
- Guaranteed 200 mA output current
- SO-8 and mini-SO8 surface mount packages
- <1 µA quiescent current when shutdown
- Low ground pin current at all loads
- 0.5% output voltage accuracy ("A" grade)
- High peak current capability (400 mA typical)
- Wide supply voltage range (16V max)
- Overtemperature/overcurrent protection
- -40°C to +125°C junction temperature range

### Applications

- Cellular Phone
- Palmtop/Laptop Computer
- Camcorder, Personal Stereo, Camera

### Block Diagram

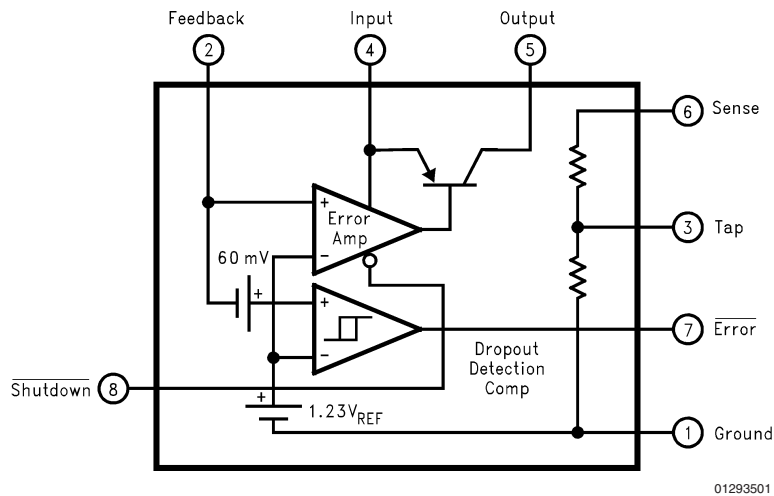

01293501

VIP™ is a trademark of National Semiconductor Corporation.

## Connection Diagrams and Ordering Information

### Surface Mount Packages:

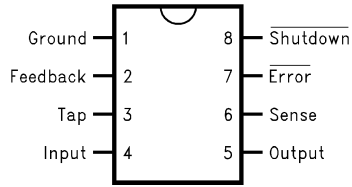

01293502

### SO-8/Mini SO-8 Package

See NS Package Drawing Number M08A/MUA08A

### 8-Lead LLP Surface Mount Package

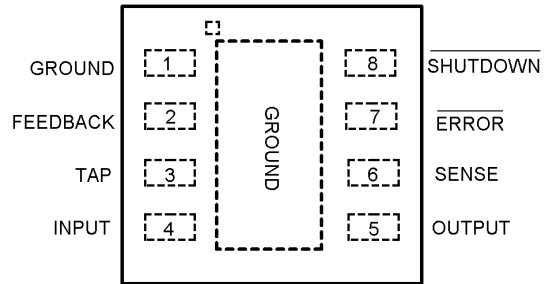

01293543

### Top View

See NS Package Drawing Number LDC08A

## Basic Application Circuits

### Application Using Internal Resistive Divider

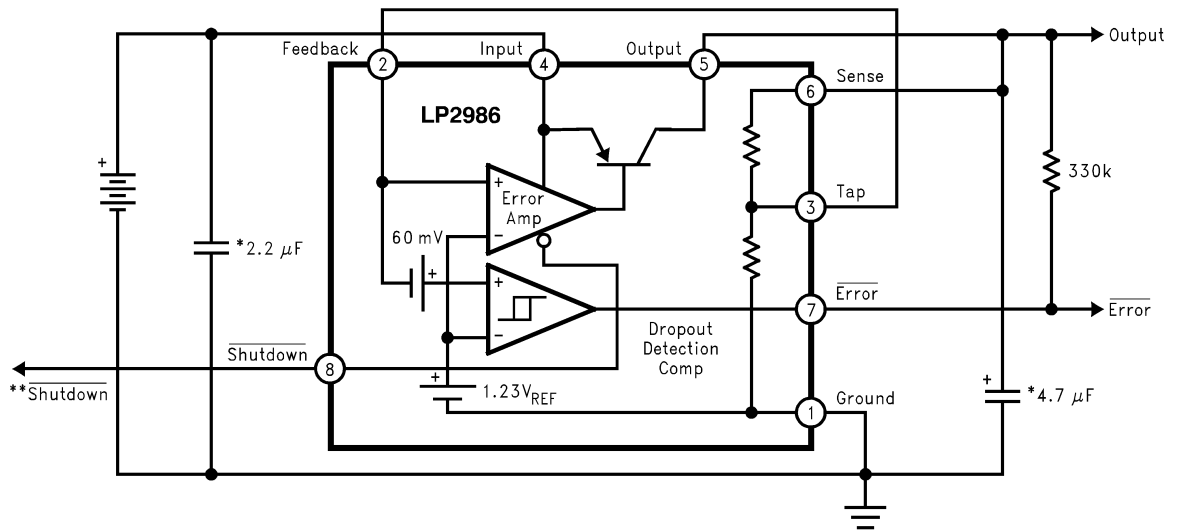

\* Minimum capacitance shown to assure stability, but may be increased without limit. Larger output capacitor provides improved dynamic response.

\*\* Shutdown input must be actively terminated. Tie to  $V_{\text{IN}}$  if not used.

01293503

**Basic Application Circuits** (Continued)

**Application Using External Divider**

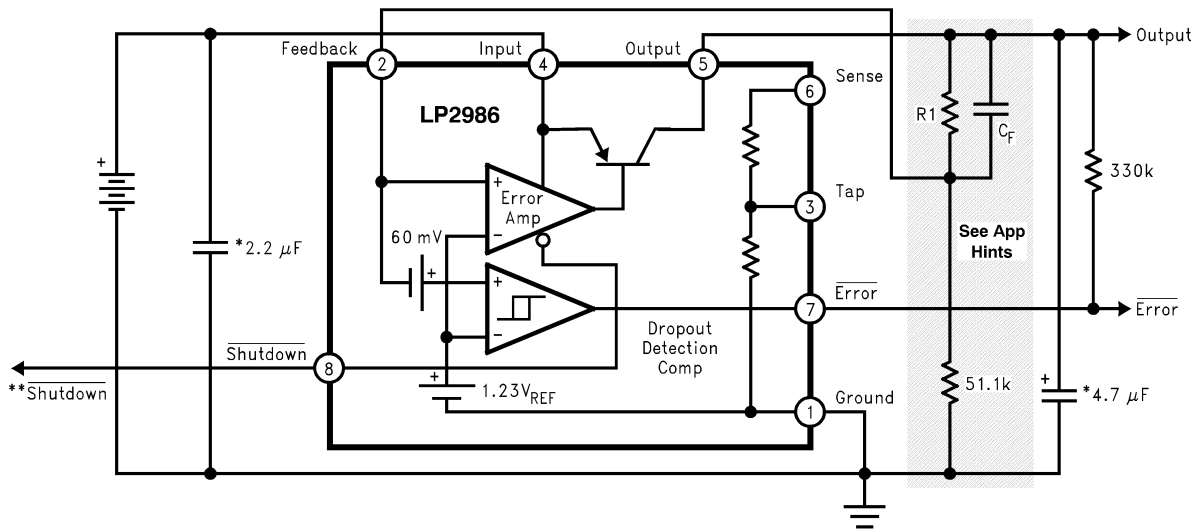

\* Minimum capacitance shown to assure stability, but may be increased without limit. Larger output capacitor provides improved dynamic response.

\*\* Shutdown input must be actively terminated. Tie to  $V_{IN}$  if not used.

01293504

**Ordering Information**

**TABLE 1. Package Marking and Ordering Information**

Output Voltage	Grade	Order Information	Package Marking	Supplied as:
<b>Mini SO-8</b>				
5	A	LP2986AIMMX-5.0	L41A	3500 Units on Tape and Reel
5	A	LP2986AIMM-5.0	L41A	1000 Units on Tape and Reel
5	STD	LP2986IMMX-5.0	L41B	3500 Units on Tape and Reel
5	STD	LP2986IMM-5.0	L41B	1000 Units on Tape and Reel
3.3	A	LP2986AIMMX-3.3	L40A	3500 Units on Tape and Reel
3.3	A	LP2986AIMM-3.3	L40A	1000 Units on Tape and Reel
3.3	STD	LP2986IMMX-3.3	L40B	3500 Units on Tape and Reel
3.3	STD	LP2986IMM-3.3	L40B	1000 Units on Tape and Reel
3.0	A	LP2986AIMMX-3.0	L39A	3500 Units on Tape and Reel
3.0	A	LP2986AIMM-3.0	L39A	1000 Units on Tape and Reel
3.0	STD	LP2986IMMX-3.0	L39B	3500 Units on Tape and Reel
3.0	STD	LP2986IMM-3.0	L39B	1000 Units on Tape and Reel

**Ordering Information** (Continued)**TABLE 1. Package Marking and Ordering Information** (Continued)

Output Voltage	Grade	Order Information	Package Marking	Supplied as:
<b>SO-8</b>				
5	A	LP2986AIMX-5.0	2986AIM5.0	2500 Units on Tape and Reel
5	A	LP2986AIM-5.0	2986AIM5.0	Shipped in Anti-Static Rails
5	STD	LP2986IMX-5.0	2986IM5.0	2500 Units on Tape and Reel
5	STD	LP2986IM-5.0	2986IM5.0	Shipped in Anti-Static Rails
3.3	A	LP2986AIMX-3.3	2986AIM3.3	2500 Units on Tape and Reel
3.3	A	LP2986AIM-3.3	2986AIM3.3	Shipped in Anti-Static Rails
3.3	STD	LP2986IMX-3.3	2986IM3.3	2500 Units on Tape and Reel
3.3	STD	LP2986IM-3.3	2986IM3.3	Shipped in Anti-Static Rails
3.0	A	LP2986AIMX-3.0	2986AIM3.0	2500 Units on Tape and Reel
3.0	A	LP2986AIM-3.0	2986AIM3.0	Shipped in Anti-Static Rails
3.0	STD	LP2986IMX-3.0	2986IM3.0	2500 Units on Tape and Reel
3.0	STD	LP2986IM-3.0	2986IM3.0	Shipped in Anti-Static Rails
<b>8-Lead LLP</b>				
5	A	LP2986AILD-5	L006A	1000 Units on Tape and Reel
5	A	LP2986AILD-5	L006A	4500 Units on Tape and Reel
5	STD	LP2986ILD-5	L006AB	1000 Units on Tape and Reel
5	STD	LP2986ILD-5	L006AB	4500 Units on Tape and Reel
3.3	A	LP2986AILD-3.3	L005A	1000 Units on Tape and Reel
3.3	A	LP2986AILD-3.3	L005A	4500 Units on Tape and Reel
3.3	STD	LP2986ILD-3.3	L005AB	1000 Units on Tape and Reel
3.3	STD	LP2986ILD-3.3	L005AB	4500 Units on Tape and Reel
3.0	A	LP2986AILD-3.0	L004A	1000 Units on Tape and Reel
3.0	A	LP2986AILD-3.0	L004A	4500 Units on Tape and Reel
3.0	STD	LP2986ILD-3.0	L004AB	1000 Units on Tape and Reel
3.0	STD	LP2986ILD-3.0	L004AB	4500 Units on Tape and Reel

### Absolute Maximum Ratings (Note 1)

If Military/Aerospace specified devices are required, please contact the National Semiconductor Sales Office/Distributors for availability and specifications.

Storage Temperature Range	-65°C to +150°C
Operating Junction Temperature Range	-40°C to +125°C
Lead Temperature (Soldering, 5 seconds)	260°C
ESD Rating (Note 2)	2 kV
Power Dissipation (Note 3)	Internally Limited

Input Supply Voltage (Survival)	-0.3V to +16V
Input Supply Voltage (Operating)	2.1V to +16V
Shutdown Pin	-0.3V to +16V
Feedback Pin	-0.3V to +5V
Output Voltage (Survival) (Note 4)	-0.3V to +16V
I <sub>OUT</sub> (Survival)	Short Circuit Protected
Input-Output Voltage (Survival) (Note 5)	-0.3V to +16V

### Electrical Characteristics

Limits in standard typeface are for T<sub>J</sub> = 25°C, and limits in **boldface type** apply over the full operating temperature range. Unless otherwise specified: V<sub>IN</sub> = V<sub>O</sub>(NOM) + 1V, I<sub>L</sub> = 1 mA, C<sub>OUT</sub> = 4.7 µF, C<sub>IN</sub> = 2.2 µF, V<sub>S/D</sub> = 2V.

Symbol	Parameter	Conditions	Typical	LM2986AI-X.X (Note 6)		LM2986I-X.X (Note 6)		Units	
				Min	Max	Min	Max		
V <sub>O</sub>	Output Voltage (5.0V Versions)	0.1 mA < I <sub>L</sub> < 200 mA	5.0	4.975	5.025	4.950	5.050	V	
			5.0	4.960	5.040	4.920	5.080		
				<b>4.910</b>	<b>5.090</b>	<b>4.860</b>	<b>5.140</b>		
	Output Voltage (3.3V Versions)	0.1 mA < I <sub>L</sub> < 200 mA	3.3	3.283	3.317	3.267	3.333		
			3.3	3.274	3.326	3.247	3.353		
				<b>3.241</b>	<b>3.359</b>	<b>3.208</b>	<b>3.392</b>		
Output Voltage (3.0V Versions)	0.1 mA < I <sub>L</sub> < 200 mA	3.0	2.985	3.015	2.970	3.030			
		3.0	2.976	3.024	2.952	3.048			
			<b>2.946</b>	<b>3.054</b>	<b>2.916</b>	<b>3.084</b>			
$\frac{V_O}{\Delta V_{IN}}$	Output Voltage Line Regulation	V <sub>O</sub> (NOM) + 1V ≤ V <sub>IN</sub> ≤ 16V	0.007		0.014		0.014	%V	
					<b>0.032</b>		<b>0.032</b>		
V <sub>IN</sub> -V <sub>O</sub>	Dropout Voltage (Note 7)	I <sub>L</sub> = 100 µA	1		2.0		2.0	mV	
				<b>3.5</b>		<b>3.5</b>			
		I <sub>L</sub> = 75 mA		90		120			120
				<b>170</b>		<b>170</b>			
	I <sub>L</sub> = 200 mA	180			230		230		
					<b>350</b>		<b>350</b>		
I <sub>GND</sub>	Ground Pin Current	I <sub>L</sub> = 100 µA	100		120		120	µA	
				<b>150</b>		<b>150</b>			
		I <sub>L</sub> = 75 mA	500		800		800		
				<b>1400</b>		<b>1400</b>			
	I <sub>L</sub> = 200 mA	1		2.1		2.1	mA		
				<b>3.7</b>		<b>3.7</b>			
	V <sub>S/D</sub> < 0.3V	0.05		<b>1.5</b>		<b>1.5</b>	µA		
I <sub>O</sub> (PK)	Peak Output Current	V <sub>OUT</sub> ≥ V <sub>O</sub> (NOM) - 5%	400	250		250		mA	
I <sub>O</sub> (MAX)	Short Circuit Current	R <sub>L</sub> = 0 (Steady State) (Note 11)	400						
e <sub>n</sub>	Output Noise Voltage (RMS)	BW = 300 Hz to 50 kHz, C <sub>OUT</sub> = 10 µF	160					µV(RMS)	
$\frac{\Delta V_{OUT}}{\Delta V_{IN}}$	Ripple Rejection	f = 1 kHz, C <sub>OUT</sub> = 10 µF	65					dB	
$\frac{\Delta V_{OUT}}{\Delta T}$	Output Voltage Temperature Coefficient	(Note 9)	20					ppm/°C	

## Electrical Characteristics (Continued)

Limits in standard typeface are for  $T_J = 25^\circ\text{C}$ , and limits in **boldface type** apply over the full operating temperature range. Unless otherwise specified:  $V_{IN} = V_O(\text{NOM}) + 1\text{V}$ ,  $I_L = 1\text{ mA}$ ,  $C_{OUT} = 4.7\ \mu\text{F}$ ,  $C_{IN} = 2.2\ \mu\text{F}$ ,  $V_{S/D} = 2\text{V}$ .

Symbol	Parameter	Conditions	Typical	LM2986AI-X.X (Note 6)		LM2986I-X.X (Note 6)		Units
				Min	Max	Min	Max	
<b>FEEDBACK PIN</b>								
$V_{FB}$	Feedback Pin Voltage		1.23	1.21	1.25	1.20	1.26	V
		(Note 10)	1.23	<b>1.20</b>	<b>1.26</b>	<b>1.19</b>	<b>1.27</b>	
$\frac{\Delta V_{FB}}{\Delta T}$	FB Pin Voltage Temperature Coefficient	(Note 9)	20					ppm/ $^\circ\text{C}$
$I_{FB}$	Feedback Pin Bias Current	$I_L = 200\text{ mA}$	150		330		330	nA
					<b>760</b>		<b>760</b>	
$\frac{I_{FB}}{\Delta T}$	FB Pin Bias Current Temperature Coefficient	(Note 9)	0.1					nA/ $^\circ\text{C}$
<b>SHUTDOWN INPUT</b>								
$V_{S/D}$	S/D Input Voltage (Note 8)	$V_H = \text{O/P ON}$	1.4	<b>1.6</b>		<b>1.6</b>		V
		$V_L = \text{O/P OFF}$	0.55		<b>0.18</b>		<b>0.18</b>	
$I_{S/D}$	S/D Input Current	$V_{S/D} = 0$	0		<b>-1</b>		<b>-1</b>	$\mu\text{A}$
		$V_{S/D} = 5\text{V}$	5		<b>15</b>		<b>15</b>	
<b>ERROR COMPARATOR</b>								
$I_{OH}$	Output "HIGH" Leakage	$V_{OH} = 16\text{V}$	0.01		1		1	$\mu\text{A}$
$V_{OL}$	Output "LOW" Voltage	$V_{IN} = V_O(\text{NOM}) - 0.5\text{V}$ , $I_O(\text{COMP}) = 300\ \mu\text{A}$	150		220		220	mV
					<b>350</b>		<b>350</b>	
$V_{THR}(\text{MAX})$	Upper Threshold Voltage		-4.6	-5.5	-3.5	-5.5	-3.5	% $V_{OUT}$
$V_{THR}(\text{MIN})$	Lower Threshold Voltage		-6.6	<b>-7.7</b>	<b>-2.5</b>	<b>-7.7</b>	<b>-2.5</b>	
				<b>-13.0</b>	<b>-3.3</b>	<b>-13.0</b>	<b>-3.3</b>	
HYST	Hysteresis		2.0					

## Electrical Characteristics (Continued)

**Note 1:** Absolute Maximum Ratings indicate limits beyond which damage to the component may occur. Electrical specifications do not apply when operating the device outside of its rated operating conditions.

**Note 2:** The ESD rating of the Feedback pin is 500V. The ESD rating of the  $V_{IN}$  pin is 1kV and the Tap pin is 1.5 kV.

**Note 3:** The maximum allowable power dissipation is a function of the maximum junction temperature,  $T_J(\text{MAX})$ , the junction-to-ambient thermal resistance,  $\theta_{J-A}$ , and the ambient temperature,  $T_A$ . The maximum allowable power dissipation at any ambient temperature is calculated using:

$$P(\text{MAX}) = \frac{T_J(\text{MAX}) - T_A}{\theta_{J-A}}$$

The value of  $\theta_{J-A}$  for the SO-8 (M) package is 160°C/W, and the mini SO-8 (MM) package is 200°C/W. The value  $\theta_{J-A}$  for the LLP (LD) package is specifically dependent on PCB trace area, trace material, and the number of layers and thermal vias. For improved thermal resistance and power dissipation for the LLP package, refer to Application Note AN-1187. Exceeding the maximum allowable power dissipation will cause excessive die temperature, and the regulator will go into thermal shutdown.

**Note 4:** If used in a dual-supply system where the regulator load is returned to a negative supply, the LM2986 output must be diode-clamped to ground.

**Note 5:** The output PNP structure contains a diode between the  $V_{IN}$  and  $V_{OUT}$  terminals that is normally reverse-biased. Forcing the output above the input will turn on this diode and may induce a latch-up mode which can damage the part (see Application Hints).

**Note 6:** Limits are 100% production tested at 25°C. Limits over the operating temperature range are guaranteed through correlation using Statistical Quality Control (SQC) methods. The limits are used to calculate National's Average Outgoing Quality Level (AOQL).

**Note 7:** Dropout voltage is defined as the input to output differential at which the output voltage drops 100 mV below the value measured with a 1V differential.

**Note 8:** To prevent mis-operation, the Shutdown input must be driven by a signal that swings above  $V_H$  and below  $V_L$  with a slew rate not less than 40 mV/ $\mu$ s (see Application Hints).

**Note 9:** Temperature coefficient is defined as the maximum (worst-case) change divided by the total temperature range.

**Note 10:**  $V_{FB} \leq V_{OUT} \leq (V_{IN} - 1)$ ,  $2.5V \leq V_{IN} \leq 16V$ ,  $100 \mu A \leq I_L \leq 200 \text{ mA}$ ,  $T_J \leq 125^\circ\text{C}$ .

**Note 11:** See Typical Performance Characteristics curves.



**Typical Performance Characteristics** Unless otherwise specified:  $T_A = 25^\circ\text{C}$ ,  $C_{OUT} = 4.7 \mu\text{F}$ ,  $C_{IN} = 2.2 \mu\text{F}$ , S/D is tied to  $V_{IN}$ ,  $V_{IN} = V_{O(NOM)} + 1\text{V}$ ,  $I_L = 1 \text{mA}$ .

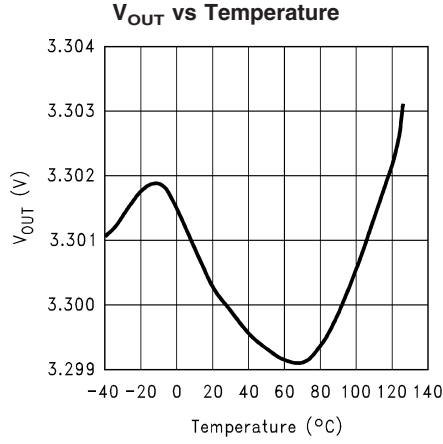

01293508

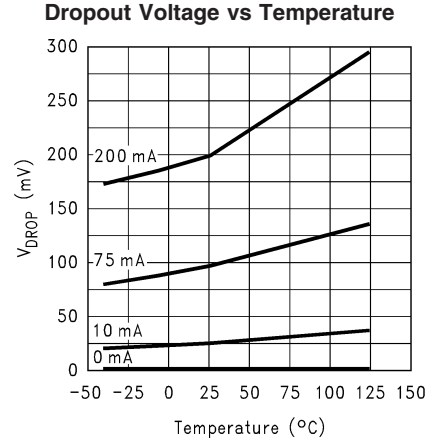

01293509

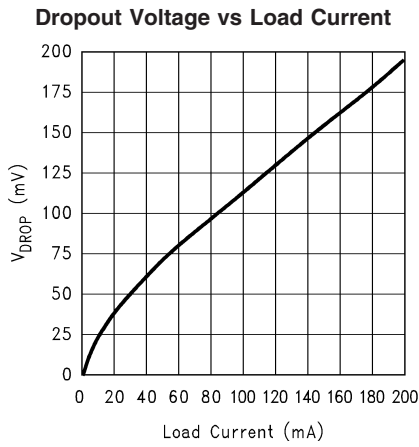

01293510

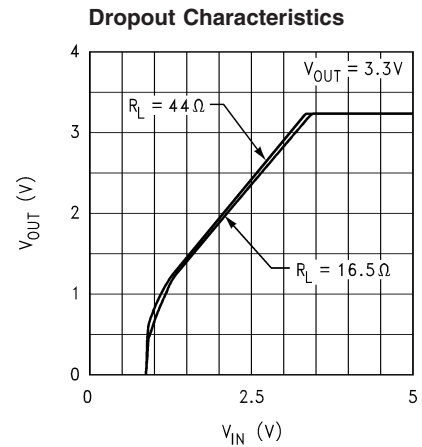

01293513

**Ground Pin Current vs Temperature and Load**

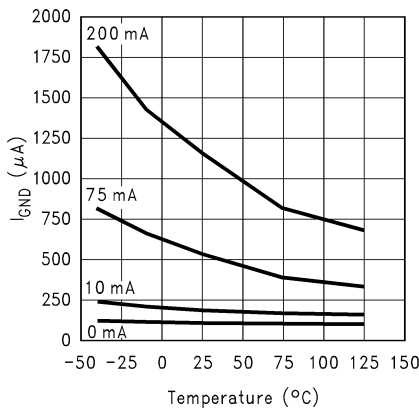

01293512

**Ground Pin Current vs Load Current**

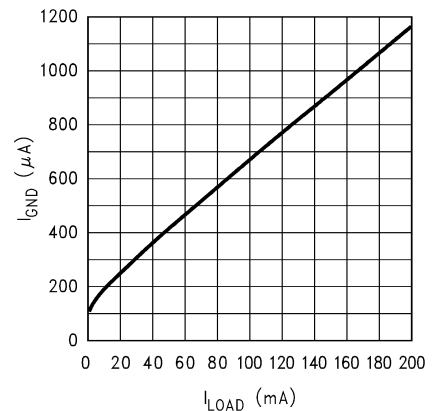

01293511

**Typical Performance Characteristics** Unless otherwise specified:  $T_A = 25^\circ\text{C}$ ,  $C_{OUT} = 4.7 \mu\text{F}$ ,  $C_{IN} = 2.2 \mu\text{F}$ , S/D is tied to  $V_{IN}$ ,  $V_{IN} = V_{O(NOM)} + 1\text{V}$ ,  $I_L = 1 \text{mA}$ . (Continued)

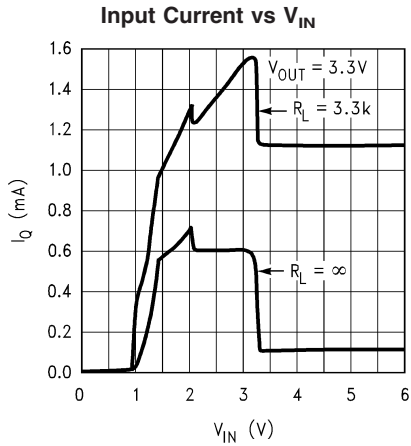

01293514

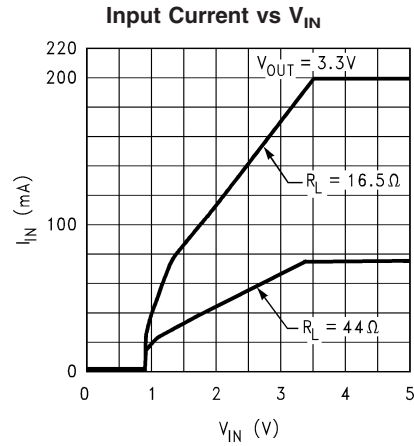

01293515

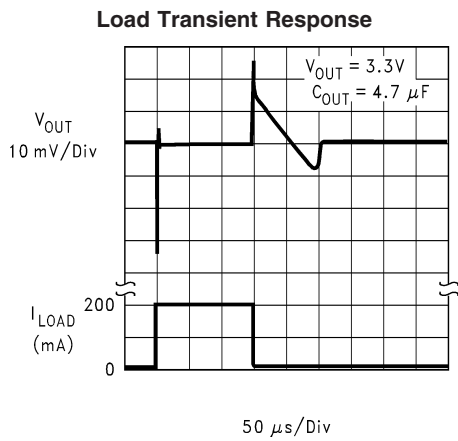

01293516

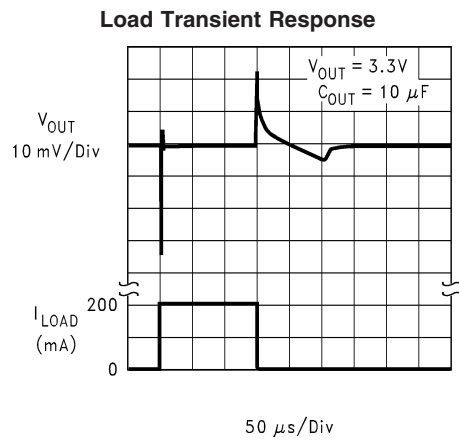

01293517

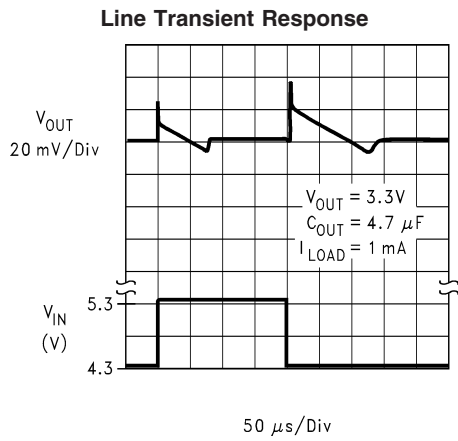

01293518

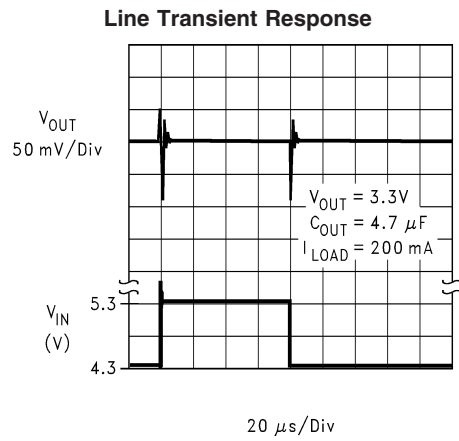

01293520

**Typical Performance Characteristics** Unless otherwise specified:  $T_A = 25^\circ\text{C}$ ,  $C_{OUT} = 4.7 \mu\text{F}$ ,  $C_{IN} = 2.2 \mu\text{F}$ , S/D is tied to  $V_{IN}$ ,  $V_{IN} = V_{O(NOM)} + 1\text{V}$ ,  $I_L = 1 \text{mA}$ . (Continued)

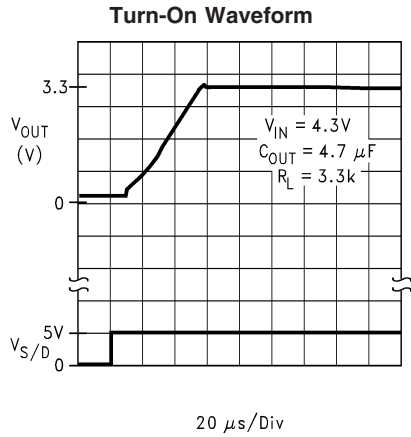

01293521

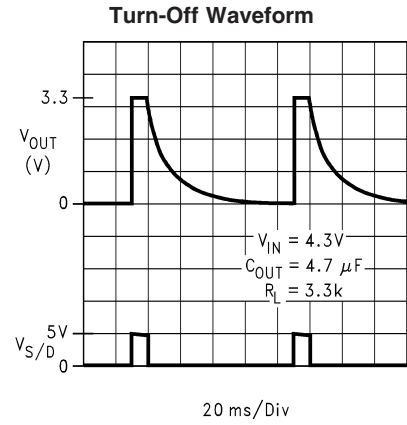

01293523

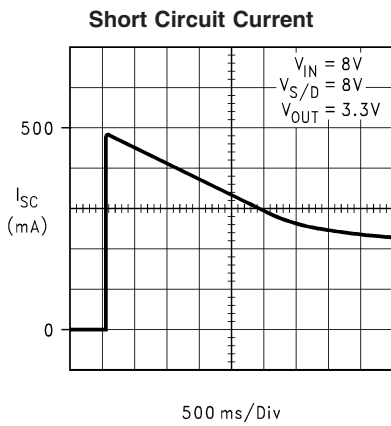

01293524

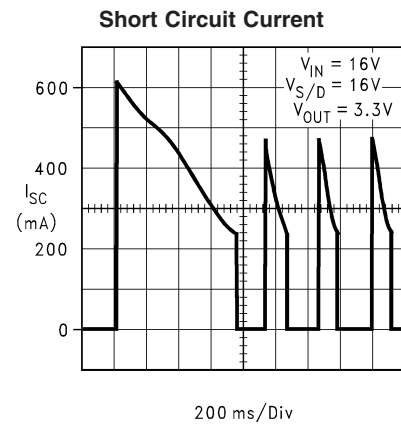

01293525

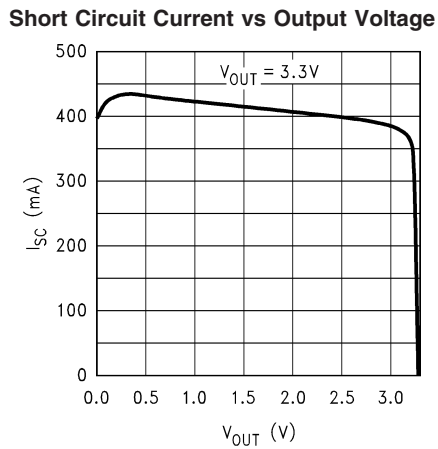

01293526

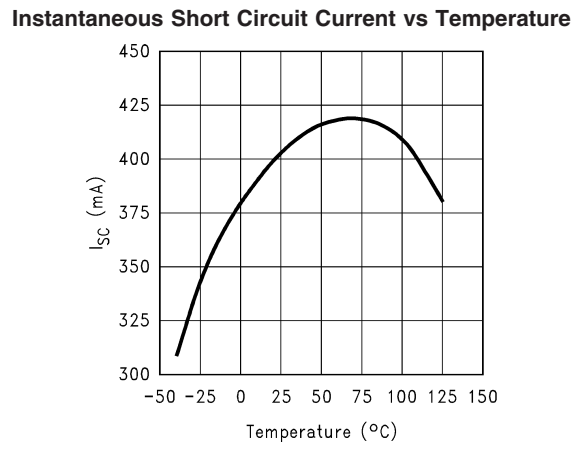

01293527

**Typical Performance Characteristics** Unless otherwise specified:  $T_A = 25^\circ\text{C}$ ,  $C_{OUT} = 4.7 \mu\text{F}$ ,  $C_{IN} = 2.2 \mu\text{F}$ , S/D is tied to  $V_{IN}$ ,  $V_{IN} = V_{O(NOM)} + 1\text{V}$ ,  $I_L = 1 \text{mA}$ . (Continued)

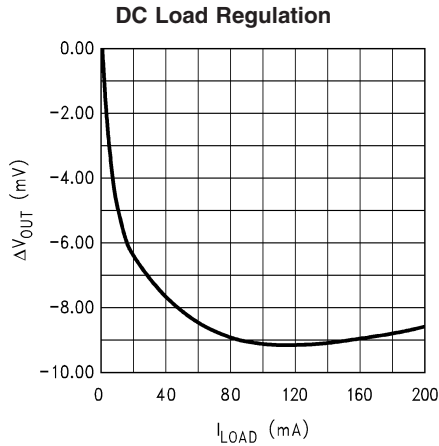

01293528

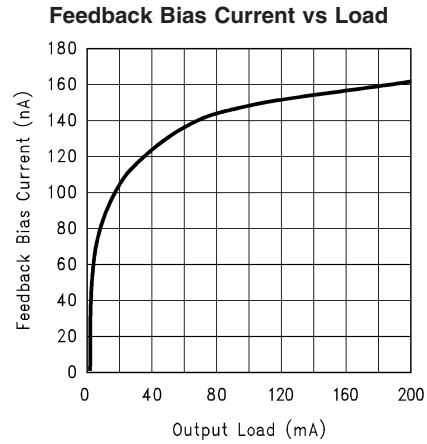

01293529

**Feedback Bias Current vs Temperature**

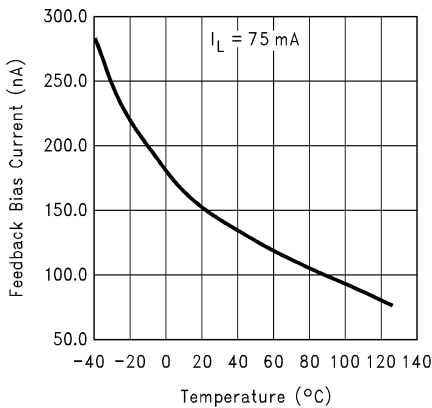

01293530

**Shutdown Pin Current vs Shutdown Pin Voltage**

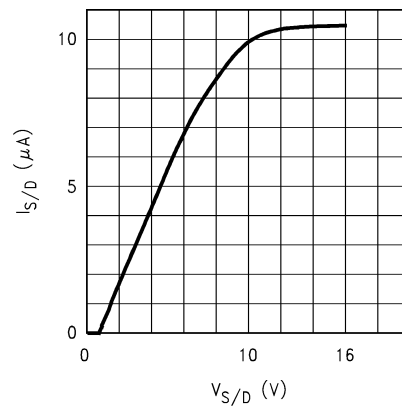

01293531

**Shutdown Voltage vs Temperature**

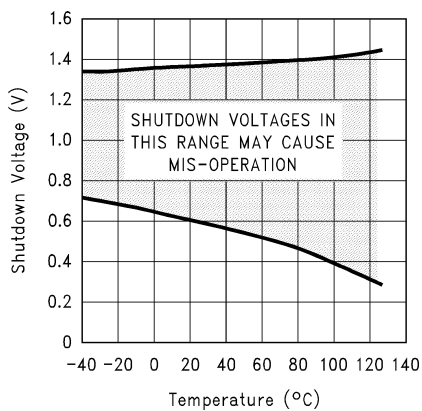

01293532

**Input to Output Leakage vs Temperature**

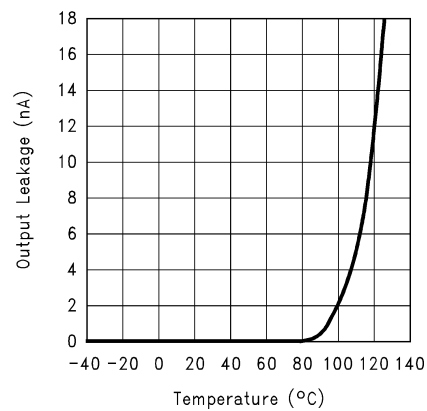

01293537

**Typical Performance Characteristics** Unless otherwise specified:  $T_A = 25^\circ\text{C}$ ,  $C_{OUT} = 4.7 \mu\text{F}$ ,  $C_{IN} = 2.2 \mu\text{F}$ , S/D is tied to  $V_{IN}$ ,  $V_{IN} = V_{O(NOM)} + 1\text{V}$ ,  $I_L = 1 \text{mA}$ . (Continued)

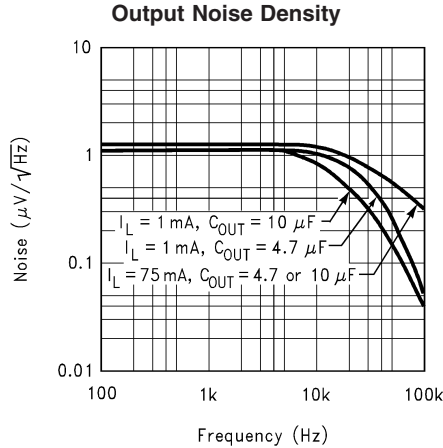

01293534

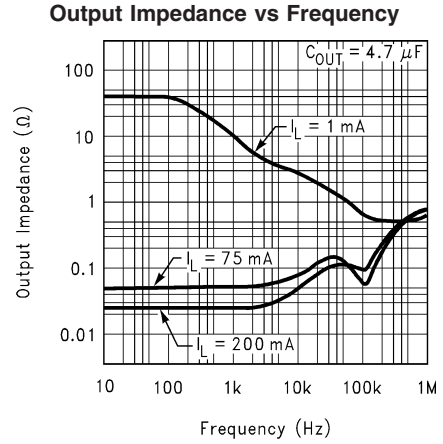

01293535

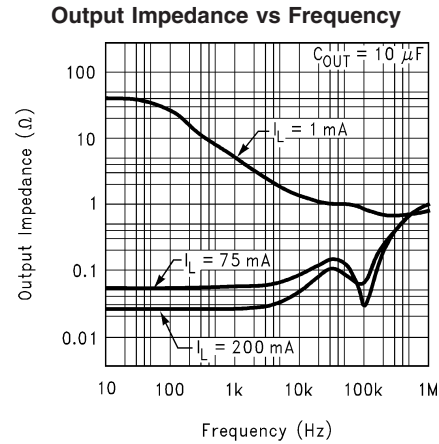

01293536

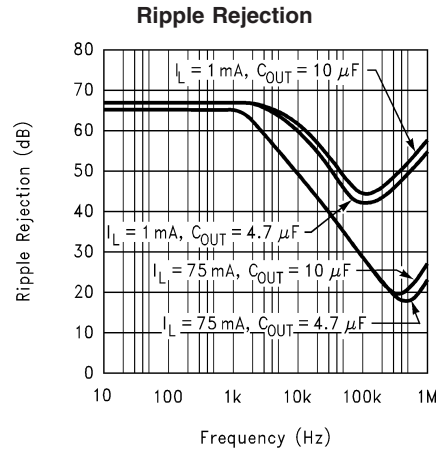

01293533

**Application Hints**

**LLP Package Devices**

The LP2986 is offered in the 8 lead LLP surface mount package to allow for increased power dissipation compared to the SO-8 and Mini SO-8. For details on thermal performance as well as mounting and soldering specifications, refer to Application Note AN-1187.

**EXTERNAL CAPACITORS**

Like any low-dropout regulator, external capacitors are required to assure stability. These capacitors must be correctly selected for proper performance.

**INPUT CAPACITOR:** An input capacitor ( $\geq 2.2 \mu\text{F}$ ) is required between the LP2986 input and ground (amount of capacitance may be increased without limit).

This capacitor must be located a distance of not more than 0.5" from the input pin and returned to a clean analog ground. Any good quality ceramic or tantalum may be used for this capacitor.

**OUTPUT CAPACITOR:** The output capacitor must meet the requirement for minimum amount of capacitance and also have an appropriate E.S.R. (equivalent series resistance) value.

Curves are provided which show the allowable ESR range as a function of load current for various output voltages and capacitor values (see ESR curves below).

**ESR Curves For 5V Output**

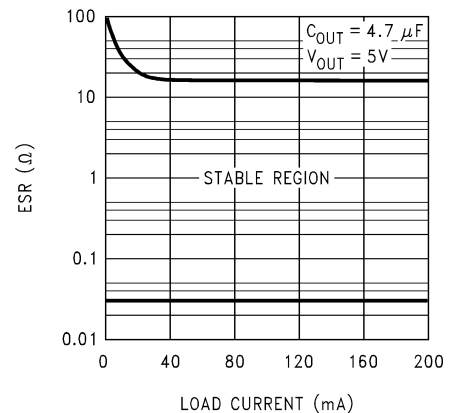

01293506

## Application Hints (Continued)

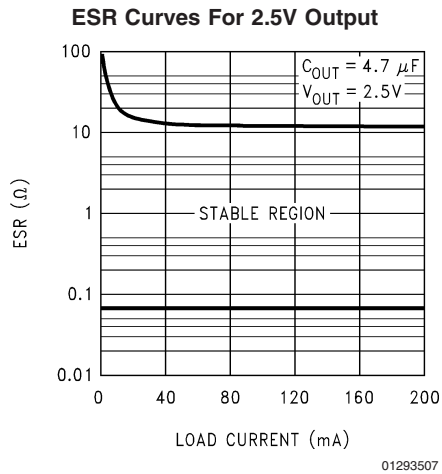

**IMPORTANT:** The output capacitor must maintain its ESR in the stable region over the full operating temperature range of the application to assure stability.

The minimum required amount of output capacitance is 4.7  $\mu\text{F}$ . Output capacitor size can be increased without limit. It is important to remember that capacitor tolerance and variation with temperature must be taken into consideration when selecting an output capacitor so that the minimum required amount of output capacitance is provided over the full operating temperature range. A good Tantalum capacitor will show very little variation with temperature, but a ceramic may not be as good (see next section).

### CAPACITOR CHARACTERISTICS

**TANTALUM:** The best choice for size, cost, and performance are solid tantalum capacitors. Available from many sources, their typical ESR is very close to the ideal value required on the output of many LDO regulators.

Tantalums also have good temperature stability: a 4.7  $\mu\text{F}$  was tested and showed only a 10% decline in capacitance as the temperature was decreased from +125°C to -40°C. The ESR increased only about 2:1 over the same range of temperature.

However, it should be noted that the increasing ESR at lower temperatures present in all tantalums can cause oscillations when marginal quality capacitors are used (where the ESR of the capacitor is near the upper limit of the stability range at room temperature).

**CERAMIC:** For a given amount of a capacitance, ceramics are usually larger and more costly than tantalums.

Be warned that the ESR of a ceramic capacitor can be low enough to cause instability: a 2.2  $\mu\text{F}$  ceramic was measured and found to have an ESR of about 15 m $\Omega$ .

If a ceramic capacitor is to be used on the LP2986 output, a 1 $\Omega$  resistor should be placed in series with the capacitor to provide a minimum ESR for the regulator.

Another disadvantage of ceramic capacitors is that their capacitance varies a lot with temperature:

Large ceramic capacitors are typically manufactured with the Z5U temperature characteristic, which results in the capacitance dropping by a 50% as the temperature goes from 25°C to 80°C.

This means you have to buy a capacitor with twice the minimum  $C_{\text{OUT}}$  to assure stable operation up to 80°C.

**ALUMINUM:** The large physical size of aluminum electrolytics makes them unattractive for use with the LP2986. Their ESR characteristics are also not well suited to the requirements of LDO regulators.

The ESR of an aluminum electrolytic is higher than a tantalum, and it also varies greatly with temperature.

A typical aluminum electrolytic can exhibit an ESR increase of 50X when going from 20°C to -40°C. Also, some aluminum electrolytics can not be used below -25°C because the electrolyte will freeze.

### USING AN EXTERNAL RESISTIVE DIVIDER

The LP2986 output voltage can be programmed using an external resistive divider (see Basic Application Circuits).

The resistor connected between the Feedback pin and ground should be 51.1k. The value for the other resistor (R1) connected between the Feedback pin and the regulated output is found using the formula:

$$V_{\text{OUT}} = 1.23 \times (1 + R1/51.1k)$$

It should be noted that the 25  $\mu\text{A}$  of current flowing through the external divider is approximately equal to the current saved by not connecting the internal divider, which means the quiescent current is not increased by using external resistors.

A lead compensation capacitor ( $C_F$ ) must also be used to place a zero in the loop response at about 50 kHz. The value for  $C_F$  can be found using:

$$C_F = 1/(2\pi \times R1 \times 50k)$$

A good quality capacitor must be used for  $C_F$  to ensure that the value is accurate and does not change significantly over temperature. Mica or ceramic capacitors can be used, assuming a tolerance of  $\pm 20\%$  or better is selected.

If a ceramic is used, select one with a temperature coefficient of NPO, COG, Y5P, or X7R. Capacitor types Z5U, Y5V, and Z4V can not be used because their value varies more than 50% over the -25°C to +85°C temperature range.

### SHUTDOWN INPUT OPERATION

The LP2986 is shut off by driving the Shutdown input low, and turned on by pulling it high. If this feature is not to be used, the Shutdown input should be tied to  $V_{\text{IN}}$  to keep the regulator output on at all times.

To assure proper operation, the signal source used to drive the Shutdown input must be able to swing above and below the specified turn-on/turn-off voltage thresholds listed as  $V_{\text{H}}$  and  $V_{\text{L}}$ , respectively (see Electrical Characteristics).

It is also important that the turn-on (and turn-off) voltage signals applied to the Shutdown input have a slew rate which is not less than 40 mV/ $\mu\text{s}$ .

**CAUTION:** the regulator output state can not be guaranteed if a slow-moving AC (or DC) signal is applied that is in the range between  $V_{\text{H}}$  and  $V_{\text{L}}$ .

### REVERSE INPUT-OUTPUT VOLTAGE

The PNP power transistor used as the pass element in the LP2986 has an inherent diode connected between the regulator output and input.

During normal operation (where the input voltage is higher than the output) this diode is reverse-biased.

However, if the output is pulled above the input, this diode will turn ON and current will flow into the regulator output.

**Application Hints** (Continued)

In such cases, a parasitic SCR can latch which will allow a high current to flow into  $V_{IN}$  (and out the ground pin), which can damage the part.

In any application where the output may be pulled above the input, an external Schottky diode must be connected from  $V_{IN}$  to  $V_{OUT}$  (cathode on  $V_{IN}$ , anode on  $V_{OUT}$ ), to limit the reverse voltage across the LP2986 to 0.3V (see Absolute Maximum Ratings).

**Physical Dimensions** inches (millimeters)

unless otherwise noted

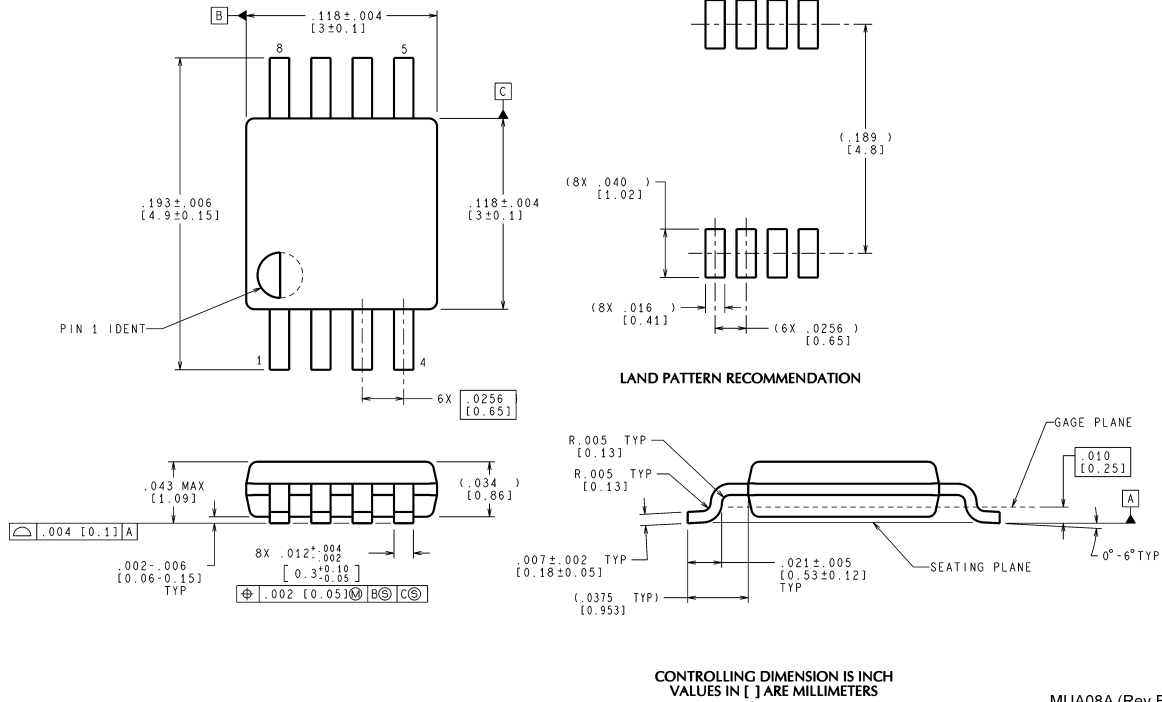

MUA08A (Rev E)

**8-Lead Mini-Small Outline Molded Package, JEDEC  
NS Package Number MUA08A**

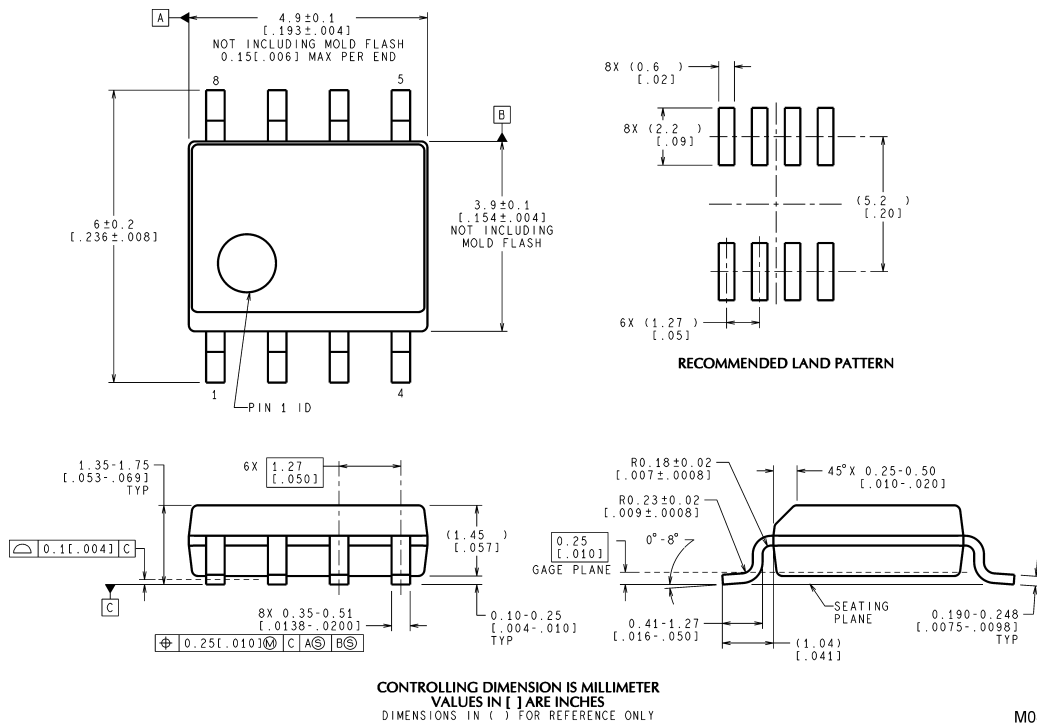

M08A (Rev K)

**8-Lead (0.150" Wide) Molded Small Outline Package, JEDEC  
NS Package Number M08A**



**Physical Dimensions** inches (millimeters) unless otherwise noted (Continued)

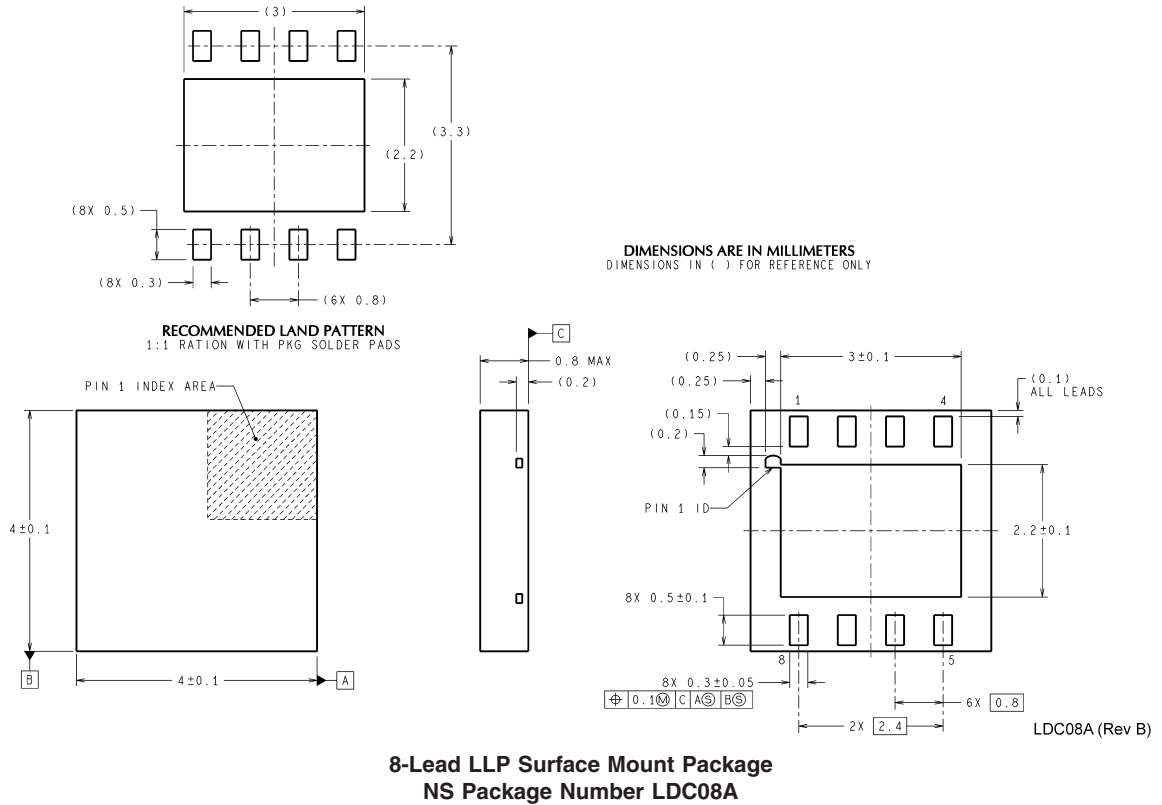

National does not assume any responsibility for use of any circuitry described, no circuit patent licenses are implied and National reserves the right at any time without notice to change said circuitry and specifications.

For the most current product information visit us at [www.national.com](http://www.national.com).

**LIFE SUPPORT POLICY**

NATIONAL'S PRODUCTS ARE NOT AUTHORIZED FOR USE AS CRITICAL COMPONENTS IN LIFE SUPPORT DEVICES OR SYSTEMS WITHOUT THE EXPRESS WRITTEN APPROVAL OF THE PRESIDENT AND GENERAL COUNSEL OF NATIONAL SEMICONDUCTOR CORPORATION. As used herein:

1. Life support devices or systems are devices or systems which, (a) are intended for surgical implant into the body, or (b) support or sustain life, and whose failure to perform when properly used in accordance with instructions for use provided in the labeling, can be reasonably expected to result in a significant injury to the user.
2. A critical component is any component of a life support device or system whose failure to perform can be reasonably expected to cause the failure of the life support device or system, or to affect its safety or effectiveness.

**BANNED SUBSTANCE COMPLIANCE**

National Semiconductor manufactures products and uses packing materials that meet the provisions of the Customer Products Stewardship Specification (CSP-9-111C2) and the Banned Substances and Materials of Interest Specification (CSP-9-111S2) and contain no "Banned Substances" as defined in CSP-9-111S2.

 **National Semiconductor**  
Americas Customer  
Support Center  
Email: [new.feedback@nsc.com](mailto:new.feedback@nsc.com)  
Tel: 1-800-272-9959

**National Semiconductor**  
Europe Customer Support Center  
Fax: +49 (0) 180-530 85 86  
Email: [europe.support@nsc.com](mailto:europe.support@nsc.com)  
Deutsch Tel: +49 (0) 69 9508 6208  
English Tel: +44 (0) 870 24 0 2171  
Français Tel: +33 (0) 1 41 91 8790

**National Semiconductor**  
Asia Pacific Customer  
Support Center  
Email: [ap.support@nsc.com](mailto:ap.support@nsc.com)

**National Semiconductor**  
Japan Customer Support Center  
Fax: 81-3-5639-7507  
Email: [jpn.feedback@nsc.com](mailto:jpn.feedback@nsc.com)  
Tel: 81-3-5639-7560