

AD741 Series

FEATURES

Precision Input Characteristics

- Low V_{OS} : 0.5 mV max (L)
- Low V_{OS} Drift: 5 $\mu\text{V}/^\circ\text{C}$ max (L)
- Low I_b : 50 nA max (L)
- Low I_{OS} : 5 nA max (L)
- High CMRR: 90 dB min (K, L)

High Output Capability

- $A_{OL} = 25,000$ min, 1 k Ω Load (J, S) T_{MIN} to T_{MAX}
- $V_O = \pm 10$ V min, 1 k Ω Load (J, S)

Chips and MIL-STD-883B Parts Available

CONNECTION DIAGRAMS

TO-99 (H) Package

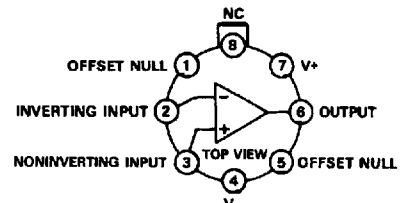

NOTE: PIN 4 CONNECTED TO CASE

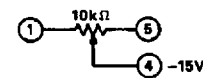

NC = NO CONNECT

Mini-DIP (N) Package

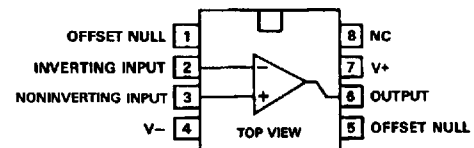

NC = NO CONNECT

GENERAL DESCRIPTION

The Analog Devices AD741 Series are high performance monolithic operational amplifiers. All the devices feature full short circuit protection and internal compensation.

The Analog Devices AD741J, AD741K, AD741L, and AD741S are specially tested and selected versions of the standard AD741 operational amplifier. Improved processing and additional electrical testing guarantee the user precision performance at a very low cost. The AD741J, K and L substantially increase overall accuracy over the standard AD741C by providing maximum limits on offset voltage drift and significantly reducing the errors due to offset voltage, bias current, offset current, voltage gain, power supply rejection and common-mode rejection. For example, the AD741L features maximum offset voltage drift of 5 $\mu\text{V}/^\circ\text{C}$, offset voltage of 0.5 mV max, offset current of 5 nA max, bias current of 50 nA max and a CMRR of 90 dB min. The AD741S offers guaranteed performance over the extended temperature range of -55°C to $+125^\circ\text{C}$, with max offset voltage drift of 15 $\mu\text{V}/^\circ\text{C}$, max offset voltage of 4 mV, max offset current of 25 nA, and a minimum CMRR of 80 dB.

HIGH OUTPUT CAPABILITY

Both the AD741J and AD741S offer the user the additional advantages of high guaranteed output current and gain at low values of load impedance. The AD741J guarantees a minimum gain of 25,000 swinging ± 10 V into a 1 k Ω load from 0°C to $+70^\circ\text{C}$. The AD741S guarantees a minimum gain of 25,000 swinging ± 10 V into a 1 k Ω load from -55°C to $+125^\circ\text{C}$.

All devices feature full short circuit protection, high gain, high common-mode range and internal compensation. The AD741J, K and L are specified for operation from 0 to $+70^\circ\text{C}$ and are available in both the TO-99 and mini-DIP packages. The AD741S is specified for operation from -55°C to $+125^\circ\text{C}$, and is available in the TO-99 package.

REV. A

Information furnished by Analog Devices is believed to be accurate and reliable. However, no responsibility is assumed by Analog Devices for its use, nor for any infringements of patents or other rights of third parties which may result from its use. No license is granted by implication or otherwise under any patent or patent rights of Analog Devices.

One Technology Way, P.O. Box 9106, Norwood, MA 02062-9106, U.S.A.
Tel: 617/329-4700 World Wide Web Site: <http://www.analog.com>
Fax: 617/326-8703 © Analog Devices, Inc., 1997

AD741 Series—SPECIFICATIONS (typical @ +25°C and ±15 V dc, unless otherwise noted)

Model	AD741C			AD741			AD741J			Units	
	Min	Typ	Max	Min	Typ	Max	Min	Typ	Max		
OPEN-LOOP GAIN $R_L = 1\text{ k}\Omega, V_O = \pm 10\text{ V}$ $R_L = 2\text{ k}\Omega, V_O = \pm 10\text{ V}$ $T_A = \text{min to max } R_L = 2\text{ k}\Omega$							50,000	200,000		V/V V/V V/V	
OUTPUT CHARACTERISTICS Voltage @ $R_L = 1\text{ k}\Omega, T_A = \text{min to max}$ Voltage @ $R_L = 2\text{ k}\Omega, T_A = \text{min to max}$ Short Circuit Current	± 10	± 13		± 10	± 13		± 10	± 13		V V mA	
FREQUENCY RESPONSE Unity Gain, Small Signal Full Power Response Slew Rate Transient Response (Unity Gain) Rise Time $C_L \leq 10\text{ V p-p}$ Overshoot		1 10 0.5 0.3 5.0			1 10 0.5 0.3 5.0			1 10 0.5 0.3 5.0		MHz kHz V/ μ s μ s %	
INPUT OFFSET VOLTAGE Initial, $R_S \leq 10\text{ k}\Omega$, Adjust to Zero $T_A = \text{min to max}$ Average vs. Temperature (Untrimmed) vs. Supply, $T_A = \text{min to max}$		1.0 1.0	6.0 7.5		1.0 1.0	5.0 6.0		1.0 30	3.0 4.0 20 100	mV mV μ V/ $^{\circ}$ C μ V/V	
INPUT OFFSET CURRENT Initial $T_A = \text{min to max}$ Average vs. Temperature		20 40	200 300		20 85	200 500		5 0.1	50 100	nA nA nA/ $^{\circ}$ C	
INPUT BIAS CURRENT Initial $T_A = \text{min to max}$ Average vs. Temperature		80 120	500 800		80 300	500 1,500		40 0.6	200 400	nA nA nA/ $^{\circ}$ C	
INPUT IMPEDANCE DIFFERENTIAL	0.3	2.0		0.3	2.0		1.0			M Ω	
INPUT VOLTAGE RANGE¹ Differential, max Safe Common-Mode, max Safe Common-Mode Rejection, $R_S \leq 10\text{ k}\Omega, T_A = \text{min to max},$ $V_{IN} = \pm 12\text{ V}$		± 12	± 13		± 12	± 13		± 15	± 30	V V	
POWER SUPPLY Rated Performance Operating Power Supply Rejection Ratio Quiescent Current Power Consumption $T_A = \text{min}$ $T_A = \text{max}$		± 15			± 15			± 5	± 15	± 18	V V V μ V/V mA mW mW
TEMPERATURE RANGE Operating Rated Performance Storage	0 -65		+70 +150	-55 -65		+125 +150	0 -65		+70 +150	$^{\circ}$ C $^{\circ}$ C	

NOTES

¹For supply voltages less than $\pm 15\text{ V}$, the absolute maximum input voltage is equal to the supply voltage.

All min and max specifications are guaranteed. Specifications shown in **boldface** are tested on all production units at final electrical test. Results from those tests are used to calculate outgoing quality levels.

Specifications subject to change without notice.

AD741 Series

Model	AD741K			AD741L			AD741S			Units
	Min	Typ	Max	Min	Typ	Max	Min	Typ	Max	
OPEN-LOOP GAIN $R_L = 1\text{ k}\Omega$, $V_O = \pm 10\text{ V}$ $R_L = 2\text{ k}\Omega$, $V_O = \pm 10\text{ V}$ $T_A = \text{min to max } R_L = 2\text{ k}\Omega$							50,000	200,000		V/V V/V V/V
OUTPUT CHARACTERISTICS Voltage @ $R_L = 1\text{ k}\Omega$, $T_A = \text{min to max}$ Voltage @ $R_L = 2\text{ k}\Omega$, $T_A = \text{min to max}$ Short Circuit Current	± 10	± 13		± 10	± 13		± 10	± 13		V V mA
FREQUENCY RESPONSE Unity Gain, Small Signal Full Power Response Slew Rate Transient Response (Unity Gain) Rise Time Overshoot		1 10 0.5 0.3 5.0			1 10 0.5 0.3 5.0			1 10 0.5 0.3 5.0		MHz kHz V/ μ s μ s %
INPUT OFFSET VOLTAGE Initial, $R_S \leq 10\text{ k}\Omega$, Adjust to Zero $T_A = \text{min to max}$ Average vs. Temperature (Untrimmed) vs. Supply, $T_A = \text{min to max}$		0.5 6.0 5	2.0 3.0 15.0		0.2 2.0 5	0.5 1.0 15.0		1.0 6.0 30	2 4 15 100	mV mV μ V/ $^{\circ}$ C μ V/V
INPUT OFFSET CURRENT Initial $T_A = \text{min to max}$ Average vs. Temperature		2 0.02	10 15 0.02		2 0.02	5 10 0.1		2 0.1	10 25 0.25	nA n nA/ $^{\circ}$ C
INPUT BIAS CURRENT Initial $T_A = \text{min to max}$ Average vs. Temperature		30 0.6	75 120 1.5		30 0.6	50 100 1.0		30 0.6	75 250 2.0	nA nA nA/ $^{\circ}$ C
INPUT IMPEDANCE DIFFERENTIAL		2.0			2.0			2.0		M Ω
INPUT VOLTAGE RANGE¹ Differential, max Safe Common-Mode, max Safe Common-Mode Rejection, $R_S = \leq 10\text{ k}\Omega$, $T_A = \text{min to max}$, $V_{IN} = \pm 12\text{ V}$		± 30 ± 15			± 30 ± 15			± 30 ± 15		V V dB
POWER SUPPLY Rated Performance Operating Power Supply Rejection Ratio Quiescent Current Power Consumption $T_A = \text{min}$ $T_A = \text{max}$		± 5	± 15 20 1.7 50	± 22	± 5	± 15 20 1.7 50	± 22	± 5	± 15 20 2.0 50 60 75	V V μ V/V mA mW mW mW
TEMPERATURE RANGE Operating Rated Performance Storage		0 -65	+70 +150		0 -65	+70 +150		-55 -65	+125 +150	$^{\circ}$ C $^{\circ}$ C

AD741 Series

ABSOLUTE MAXIMUM RATINGS

Absolute Maximum Ratings	AD741, J, K, L, S	AD741C
Supply Voltage	±22 V	±18 V
Internal Power Dissipation	500 mW ¹	500 mW
Differential Input Voltage	±30 V	±30 V
Input Voltage	±15 V	±15 V
Storage Temperature Range	-65°C to +150°C	-65°C to +150°C
Lead Temperature (Soldering, 60 sec)	+300°C	+300°C
Output Short Circuit Duration	Indefinite ²	Indefinite

NOTES

¹Rating applies for case temperature to +125°C. Derate TO-99 linearity at 6.5 mW/°C for ambient temperatures above +70°C.

²Rating applies for shorts to ground or either supply at case temperatures to +125°C or ambient temperatures to +75°C.

ORDERING GUIDE

Model ¹	Temperature Range	Initial Off Set Voltage	Package Description	Package Option
AD741CN	0°C to +70°C	6.0 mV	Mini-DIP	(N-8)
AD741CH	0°C to +70°C	6.0 mV	TO-99	(H-08A)
AD741JN	0°C to +70°C	3.0 mV	Mini-DIP	(N-8)
AD741JH	0°C to +70°C	3.0 mV	TO-99	(H-08A)
AD741KN	0°C to +70°C	2.0 mV	Mini-DIP	(N-8)
AD741KH	0°C to +70°C	2.0 mV	TO-99	(H-08A)
AD741LN	0°C to +70°C	0.5 mV	Mini-DIP	(N-8)
AD741LH	0°C to +70°C	0.5 mV	TO-99	(H-08A)
AD741H	-55°C to +125°C	5.0 mV	TO-99	(H-08A)
AD741SH	-55°C to +125°C	2.0 mV	TO-99	(H-08A)

NOTE

¹J, K and S grade chips also available.

METALIZATION PHOTOGRAPH

All versions of the AD741 are available in chip form.

Contact factory for latest dimensions.

Dimensions shown in inches and (mm).

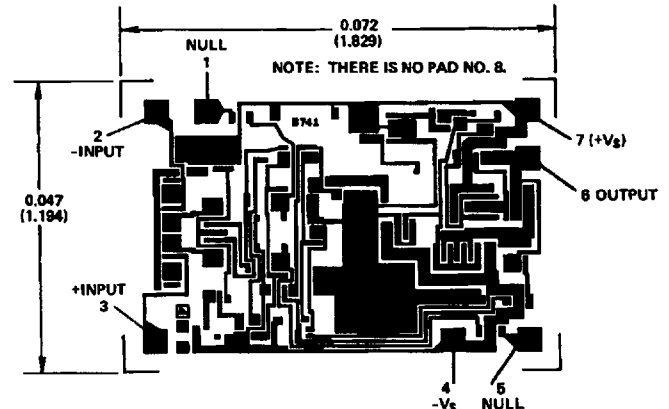

PAD NUMBERS CORRESPOND TO PIN NUMBERS FOR THE TO-99 8-PIN METAL PACKAGE.

OUTLINE DIMENSIONS

Dimensions shown in inches and (mm).

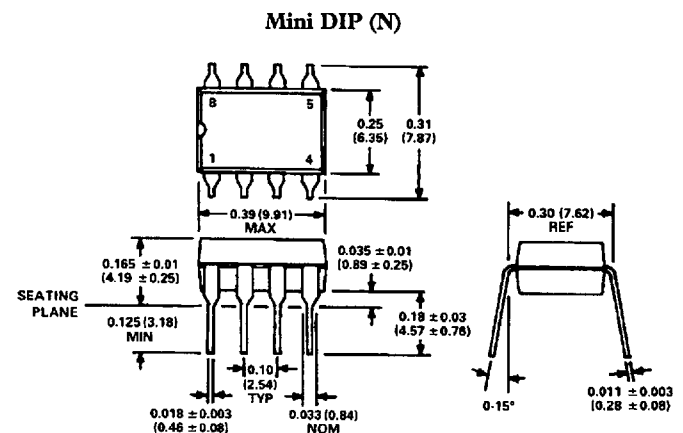
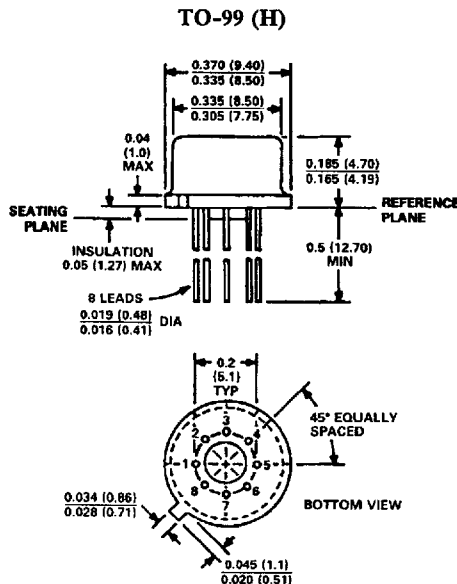

AD741 Series—Typical Performance Curves

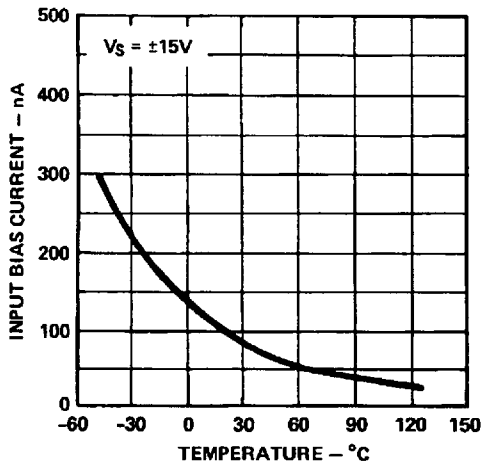

Figure 1. Input Bias Current vs. Temperature

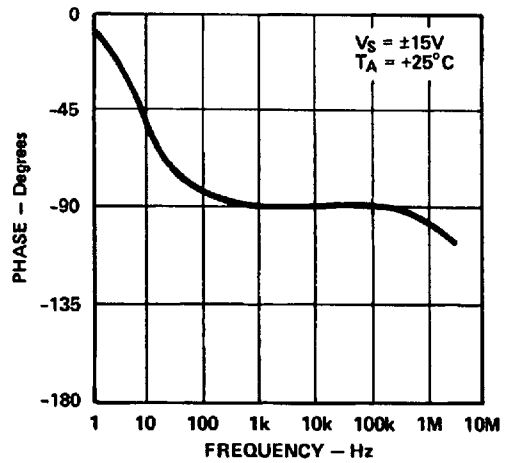

Figure 4. Open-Loop Phase Response vs. Frequency

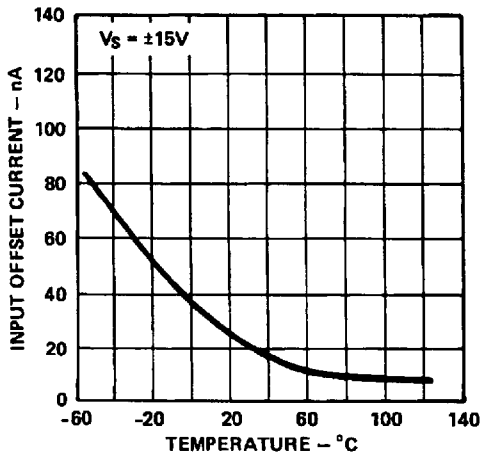

Figure 2. Input Offset Current vs. Temperature

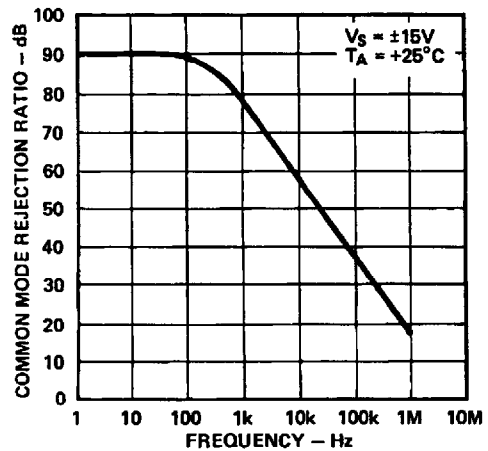

Figure 5. Common-Mode Rejection vs. Frequency

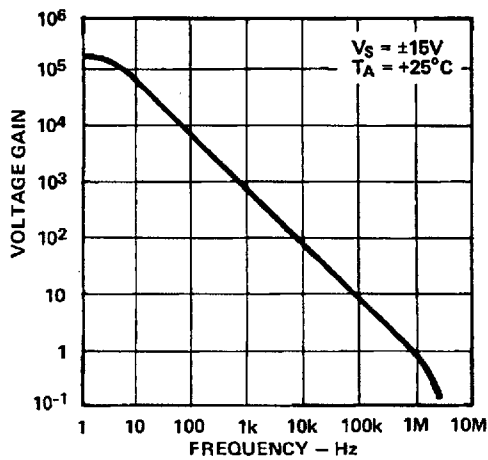

Figure 3. Open-Loop Gain vs. Frequency

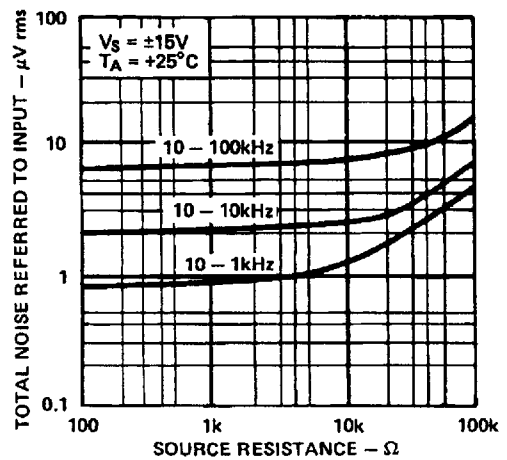

Figure 6. Broad Band Noise vs. Source Resistance

AD741 Series

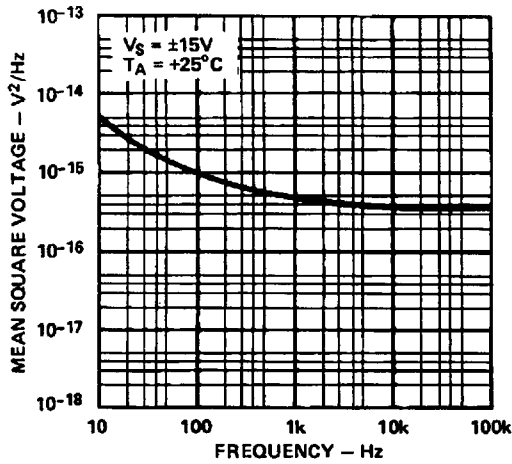

Figure 7. Input Noise Voltage vs. Frequency

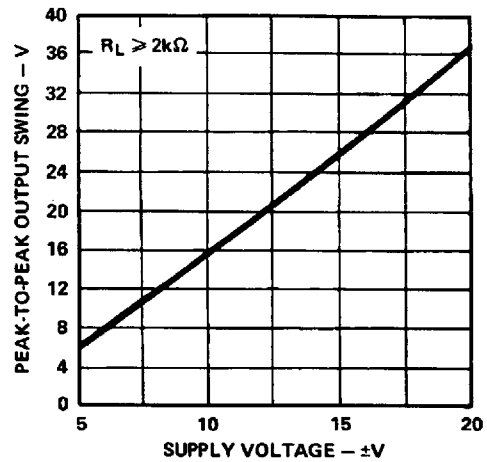

Figure 10. Output Voltage Swing vs. Supply Voltage

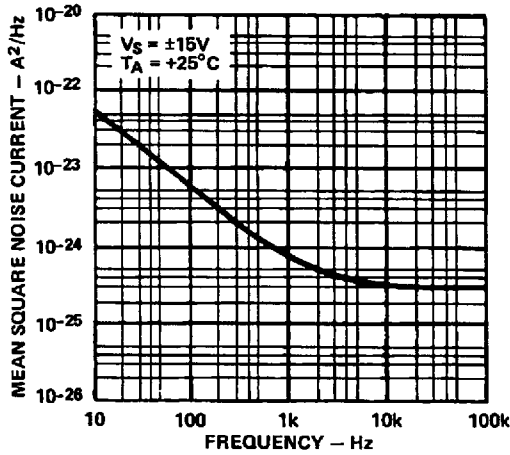

Figure 8. Input Noise Current vs. Frequency

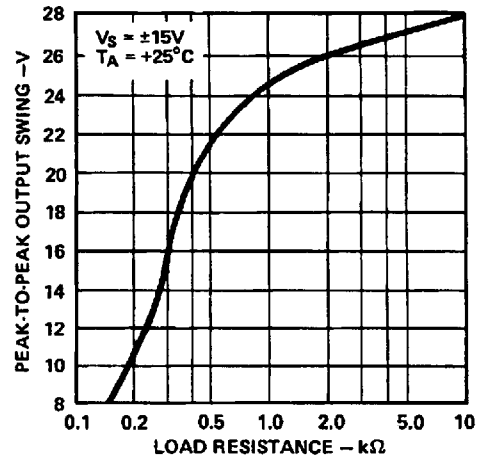

Figure 11. Output Voltage Swing vs. Load Resistance

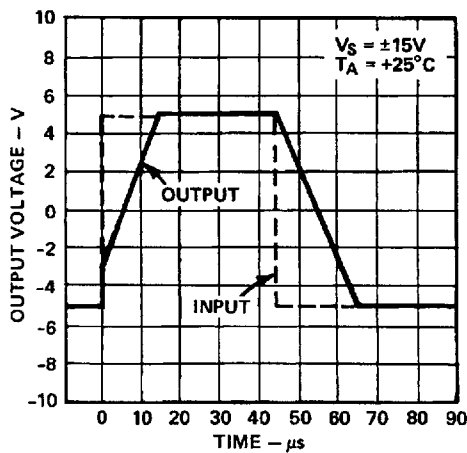

Figure 9. Voltage Follower Large Signal Pulse Response

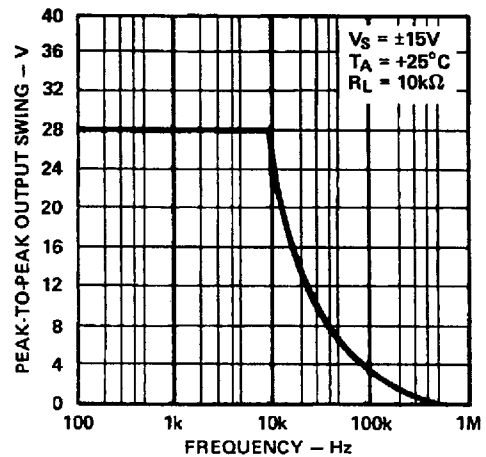

Figure 12. Output Voltage Swing vs. Frequency

C687b-0-5/97

PRINTED IN U.S.A.