

## **Not Recommended for New Designs**

---

This product was manufactured for Maxim by an outside wafer foundry using a process that is no longer available. It is not recommended for new designs. The data sheet remains available for existing users.

A Maxim replacement or an industry second-source may be available. Please see the QuickView data sheet for this part or contact technical support for assistance.

For further information, [contact Maxim's Applications Tech Support](#).

# MAXIM

## Low Offset Voltage Operational Amplifier

OP07

### General Description

The OP07 is a precision operational amplifier with very low input offset voltage ( $10\mu\text{V}$  typ.,  $25\mu\text{V}$  max. for the OP07A), input offset drift of  $0.2\mu\text{V}/^\circ\text{C}$  and low input bias current of  $0.7\text{nA}$ . The wide input common mode range of  $\pm 14\text{V}$  combined with high CMRR of 110dB minimum (OP07A), plus high input impedance and high open-loop gain make these devices particularly useful for high-gain instrumentation applications.

The excellent linearity and gain accuracy are maintained at high open-loop gains, over both time and temperature. The OP07 has become an industry standard and Maxim's reliability and quality are added advantages.

### Applications

- Precision Amplifiers
- Thermocouple Amplifiers
- Low Level Signal Processing
- Medical Instrumentation
- Strain Gauge Amplifiers
- High Accuracy Data Acquisition

### Pin Configuration

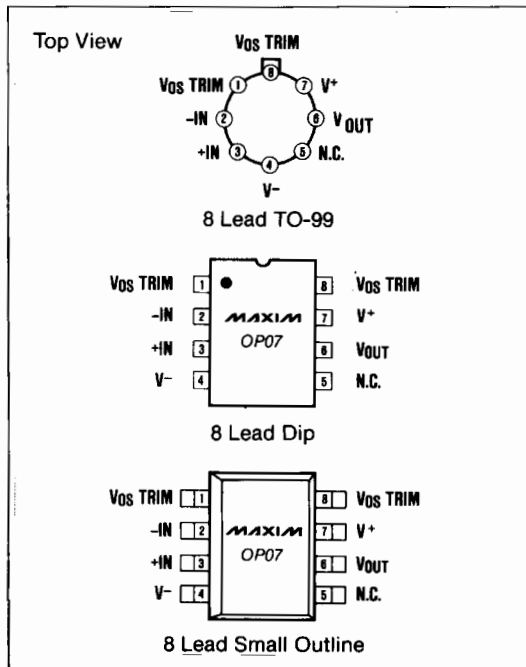

### Features

- ◆ Ultra Low Offset Voltage:  $10\mu\text{V}$
- ◆ Ultra Low Offset Voltage Drift:  $0.2\mu\text{V}/^\circ\text{C}$
- ◆ Ultra Stable vs. Time:  $0.2\mu\text{V}/\text{Month}$
- ◆ Ultra Low Noise:  $0.35\mu\text{V}_{\text{p-p}}$
- ◆ Wide Supply Voltage:  $\pm 3\text{V}$  to  $\pm 18\text{V}$
- ◆ High Common Mode Input:  $\pm 14\text{V}$
- ◆ No External Components Required
- ◆ Fits AD510, 725, 108A/308A, 741 Sockets

### Ordering Information

PART	TEMP. RANGE	PACKAGE
OP07AJ	$-55^\circ\text{C}$ to $+125^\circ\text{C}$	TO-99
OP07J	$-55^\circ\text{C}$ to $+125^\circ\text{C}$	TO-99
OP07EJ	$0^\circ\text{C}$ to $+70^\circ\text{C}$	TO-99
OP07CJ	$0^\circ\text{C}$ to $+70^\circ\text{C}$	TO-99
OP07DJ	$0^\circ\text{C}$ to $+70^\circ\text{C}$	TO-99
OP07EP	$0^\circ\text{C}$ to $+70^\circ\text{C}$	8 Lead Plastic Dip
OP07CP	$0^\circ\text{C}$ to $+70^\circ\text{C}$	8 Lead Plastic Dip
OP07DP	$0^\circ\text{C}$ to $+70^\circ\text{C}$	8 Lead Plastic Dip
OP07AZ	$-55^\circ\text{C}$ to $+125^\circ\text{C}$	8 Lead Hermetic Dip
OP07Z	$-55^\circ\text{C}$ to $+125^\circ\text{C}$	8 Lead Hermetic Dip
OP07EZ	$0^\circ\text{C}$ to $+70^\circ\text{C}$	8 Lead Hermetic Dip
OP07CZ	$0^\circ\text{C}$ to $+70^\circ\text{C}$	8 Lead Hermetic Dip
OP07ECSA	$0^\circ\text{C}$ to $+70^\circ\text{C}$	8 Lead Small Outline
OP07CCSA	$0^\circ\text{C}$ to $+70^\circ\text{C}$	8 Lead Small Outline
OP07DCSA	$0^\circ\text{C}$ to $+70^\circ\text{C}$	8 Lead Small Outline
OP07D/D	$0^\circ\text{C}$ to $+70^\circ\text{C}$	Dice

\* Contact factory for dice specifications.

### Typical Operating Circuit

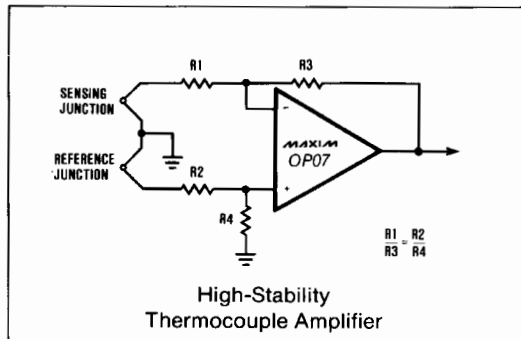

# Low Offset Voltage Operational Amplifier

## ABSOLUTE MAXIMUM RATINGS

Total Supply Voltage ( $V^+$ to $V^-$ )	±22V	Storage Temperature Range	-65°C to +150°C
Internal Power Dissipation	500mW	Operating Temperature Range	
TO-99(J) — derate at 7.1mW/°C above +80°C		OP07AJ, OP07AZ, OP07J and OP07Z	-55°C to +125°C
Hermetic Dip(Z) — derate at 6.7mW/°C above +75°C		All Other Parts	0°C to +70°C
Plastic Dip(P) — derate at 5.6mW/°C above +36°C		Lead Temperature (Soldering, 10 sec)	+300°C
Small Outline — derate at 5mW/°C above +55°C		Duration of Output Short Circuit	Indefinite
Differential Input Voltage	±30V	Junction Temperature ( $T_J$ )	-65°C to +160°C
Input Voltage (Note 1)	±22V		

**Note 1:** For supply voltages less than ±22V, the absolute maximum input voltage is equal to the supply voltage.

Stresses above those listed under "Absolute Maximum Ratings" may cause permanent damage to the device. These are stress ratings only and functional operation of the device at these or any other conditions above those indicated in the operational sections of the specifications is not implied. Exposure to absolute maximum rating conditions for extended periods may affect device reliability.

## ELECTRICAL CHARACTERISTICS

( $V_S = \pm 15V$ ,  $T_A = +25^\circ C$ , unless otherwise noted.)

PARAMETER	SYMBOL	CONDITIONS	OP07A			OP07			UNITS
			MIN	TYP	MAX	MIN	TYP	MAX	
Input Offset Voltage	$V_{OS}$	(Note 2)		10	25		30	75	$\mu V$
Long Term Input Offset Voltage Stability	$V_{OS}/\text{Time}$	(Note 3)		0.2	1.0		0.2	1.0	$\mu V/\text{Month}$
Input Offset Current	$I_{OS}$			0.3	2.0		0.4	2.8	nA
Input Bias Current	$I_B$			±0.7	±2.0		±1.0	±3.0	nA
Input Noise Voltage	$e_{N P-P}$	0.1Hz to 10Hz (Note 4)		0.35	0.6		0.35	0.6	$\mu V_{P-P}$
Input Noise Voltage Density	$e_N$	$f_O = 10\text{Hz}$ (Note 4)		10.3	18.0		10.3	18.0	$nV/\sqrt{Hz}$
		$f_O = 100\text{Hz}$ (Note 4)		10.0	13.0		10.0	13.0	
		$f_O = 1000\text{Hz}$ (Note 4)		9.6	11.0		9.6	11.0	
Input Noise Current	$I_{N P-P}$	0.1Hz to 10Hz (Note 4)		14	30		14	30	$pA_{P-P}$
Input Noise Current Density	$I_N$	$f_O = 10\text{Hz}$ (Note 4)		0.32	0.80		0.32	0.80	$pA/\sqrt{Hz}$
		$f_O = 100\text{Hz}$ (Note 4)		0.14	0.23		0.14	0.23	
		$f_O = 1000\text{Hz}$ (Note 4)		0.12	0.17		0.12	0.17	
Input Resistance Differential-Mode	$R_{IN}$	(Note 5)	30	80		20	60	M $\Omega$	
Input Resistance Common-Mode	$R_{INCM}$			200			200	G $\Omega$	
Input Voltage Range	IVR		±13	±14		±13	±14	V	
Common-Mode Rejection Ratio	CMRR	$V_{CM} = \pm 13V$	110	126		110	126	dB	
Power Supply Rejection Ratio	PSRR	$V_S = \pm 3V$ to $\pm 18V$		4	10		4	10	$\mu V/V$
Large Signal Voltage Gain	$A_{VO}$	$R_L \geq 2k\Omega$ , $V_O = \pm 10V$	300	500		200	500	V/mV	
		$R_L \geq 500\Omega$ , $V_O = \pm 0.5V$ $V_S = \pm 3V$ (Note 5)	150	400		150	400		
Output Voltage Swing	$V_O$	$R_L \geq 10k\Omega$	±12.5	±13.0		±12.5	±13.0	V	
		$R_L \geq 2k\Omega$	±12.0	±12.8		±12.0	±12.8		
		$R_L \geq 1k\Omega$	±10.5	±12.0		±10.5	±12.0		

**Note 2:** OP07A grade  $V_{OS}$  is measured one minute after application of power. For all other grades  $V_{OS}$  is measured approximately 0.5 seconds after application of power.

**Note 3:** Long-Term Input Offset Voltage Stability refers to the average trend line of  $V_{OS}$  vs. Time over extended periods after the first 30 days of operation. Excluding the initial hour of operation, changes in  $V_{OS}$  during the first 30 operating days are typically 2.5 $\mu V$ . Parameter is sample tested.

**Note 4:** Sample tested.

**Note 5:** Guaranteed by design.

# Low Offset Voltage Operational Amplifier

**OP07**

## ELECTRICAL CHARACTERISTICS (continued)

( $V_S = \pm 15V$ ,  $T_A = +25^\circ C$ , unless otherwise noted.)

PARAMETER	SYMBOL	CONDITIONS	OP07A			OP07			UNITS
			MIN	TYP	MAX	MIN	TYP	MAX	
Slew Rate	SR	$R_L \geq 2k\Omega$ (Note 6)	0.1	0.3		0.1	0.3		V/ $\mu$ S
Closed-Loop Bandwidth	BW	$A_{VCL} = +1V$ (Note 6)	0.4	0.6		0.4	0.6		MHz
Open-Loop Output Resistance	$R_O$	$V_O = 0V$ , $I_O = 0$		60			60		$\Omega$
Power Consumption	$P_D$	$V_S = \pm 15V$ , No Load $V_S = \pm 3V$ , No Load		75 4	120 6		75 4	120 6	mW
Offset Adjustment Range		$R_p = 20k\Omega$		$\pm 4$			$\pm 4$		mV

**Note 6:** Sample tested.

## ELECTRICAL CHARACTERISTICS

( $V_S = \pm 15V$ ,  $-55^\circ C \leq T_A \leq +125^\circ C$ , unless otherwise noted.)

PARAMETER	SYMBOL	CONDITIONS	OP07A			OP07			UNITS
			MIN	TYP	MAX	MIN	TYP	MAX	
Input Offset Voltage	$V_{OS}$	(Note 7)		25	60		60	200	$\mu$ V
Average Temperature Coefficient of Input Offset Voltage	$TCV_{OS}$	(Note 8)		0.2	0.6		0.3	1.3	$\mu$ V/ $^\circ$ C
Input Offset Current	$I_{OS}$			0.8	4.0		1.2	5.6	nA
Average Input Offset Current Drift	$TCI_{OS}$	(Note 8)		5	25		8	50	pA/ $^\circ$ C
Input Bias Current	$I_B$			$\pm 1.0$	$\pm 4.0$		$\pm 2.0$	$\pm 6.0$	nA
Average Input Bias Current Drift	$TCI_B$	(Note 8)		8	25		13	50	pA/ $^\circ$ C
Input Voltage Range	$IVR$		$\pm 13$	$\pm 13.5$		$\pm 13$	$\pm 13.5$		V
Common-Mode Rejection Ratio	CMRR	$V_{CM} = \pm 13V$	106	123		106	123		dB
Power Supply Rejection Ratio	PSRR	$V_S = \pm 3V$ to $\pm 18V$		5	20		5	20	$\mu$ V/V
Large Signal Voltage Gain	$A_{VO}$	$R_L \geq 2k\Omega$ , $V_O = \pm 10V$	200	400		150	400		V/mV
Output Voltage Swing	$V_O$	$R_L \geq 2k\Omega$	$\pm 12.0$	$\pm 12.6$		$\pm 12.0$	$\pm 12.6$		V

**Note 7:** OP07A grade Offset Voltage is measured one minute after application of power. For all other grades  $V_{OS}$  is measured 0.5 seconds after power on.

**Note 8:** Sample tested.

# Low Offset Voltage Operational Amplifier

## ELECTRICAL CHARACTERISTICS

( $V_S = \pm 15V$ ,  $T_A = +25^\circ C$ , unless otherwise noted.)

PARAMETER	SYMBOL	CONDITIONS	OP07E			OP07C			OP07D			
			MIN.	TYP.	MAX.	MIN.	TYP.	MAX.	MIN.	TYP.	MAX.	
Input Offset Voltage	$V_{OS}$	(Note 1)	30	75		60	150		60	150	$\mu V$	
Long Term Input Offset Voltage Stability	$V_{OS}/\text{Time}$	(Note 2)	0.3	1.5		0.4	2.0		0.5	3.0	$\mu V/\text{Month}$	
Input Offset Current	$I_{OS}$		0.5	3.8		0.8	6.0		0.8	6.0	nA	
Input Bias Current	$I_B$		$\pm 1.2$	$\pm 4.0$		$\pm 1.8$	$\pm 7.0$		$\pm 2.0$	$\pm 12.0$	nA	
Input Noise Voltage	$e_{N P-P}$	0.1Hz to 10Hz (Note 3)	0.35	0.6		0.38	0.65		0.38	0.65	$\mu V_{P-P}$	
Input Noise Voltage Density	$e_N$	$f_O = 10\text{Hz}$ (Note 3)	10.3	18.0		10.5	20.0		10.5	20.0	$nV/\sqrt{\text{Hz}}$	
		$f_O = 100\text{Hz}$ (Note 3)	10.0	13.0		10.2	13.5		10.3	13.5		
		$f_O = 1000\text{Hz}$ (Note 3)	9.6	11.0		9.8	11.5		9.8	11.5		
Input Noise Current	$I_{N P-P}$	0.1Hz to 10Hz (Note 3)	14	30		15	35		15	35	$pA_{P-P}$	
Input Noise Current Density	$I_N$	$f_O = 10\text{Hz}$ (Note 3)	0.32	0.80		0.35	0.90		0.35	0.90	$pA/\sqrt{\text{Hz}}$	
		$f_O = 100\text{Hz}$ (Note 3)	0.14	0.23		0.15	0.27		0.15	0.27		
		$f_O = 1000\text{Hz}$ (Note 3)	0.12	0.17		0.13	0.18		0.13	0.18		
Input Resistance Differential-Mode	$R_{IN}$	(Note 4)	15	50		8	33		7	31	$M\Omega$	
Input Resistance Common-Mode	$R_{INCM}$		160		120		120		120		$G\Omega$	
Input Voltage Range	IVR		$\pm 13$	$\pm 14$		$\pm 13$	$\pm 14$		$\pm 13$	$\pm 14$	V	
Common-Mode Rejection Ratio	CMRR	$V_{CM} = \pm 13V$	106	123		100	120		94	110	dB	
Power Supply Rejection Ratio	PSRR	$V_S = \pm 3V$ to $\pm 18V$	5	20		7	32		7	32	$\mu V/V$	
Large Signal Voltage Gain	$A_{VO}$	$R_L \geq 2k\Omega$ , $V_O = \pm 10V$	200	500		120	400		120	400	V/mV	
		$R_L \geq 500\Omega$ , $V_O = \pm 0.5V$ $V_S = \pm 3V$ (Note 5)	150	400		100	400		400	400		
Output Voltage Swing	$V_O$	$R_L \geq 10k\Omega$	$\pm 12.5$	$\pm 13.0$		$\pm 12.0$	$\pm 13.0$		$\pm 12.0$	$\pm 13.0$	V	
		$R_L \geq 2k\Omega$	$\pm 12.0$	$\pm 12.8$		$\pm 11.5$	$\pm 12.8$		$\pm 11.5$	$\pm 12.8$		
		$R_L \geq 1k\Omega$	$\pm 10.5$	$\pm 12.0$		$\pm 12.0$		$\pm 12.0$		$\pm 12.0$		
Slew Rate	SR	$R_L \geq 2k\Omega$ (Note 3)	0.1	0.3		0.1	0.3		0.1	0.3	$V/\mu S$	
Closed-Loop Bandwidth	BW	$A_{VCL} = +1V$ (Note 3)	0.4	0.6		0.4	0.6		0.4	0.6	MHz	
Open-Loop Output Resistance	$R_O$	$V_O = 0V$ , $I_O = 0$	60			60			60		$\Omega$	
Power Consumption	$P_d$	$V_S = \pm 15V$ , No Load	75	120		80	150		80	150	mW	
		$V_S = \pm 3V$ , No Load	4	6		4	8		4	8		
Offset Adjustment Range		$R_P = 20k\Omega$	$\pm 4$			$\pm 4$			$\pm 4$		mV	

**Note 1:** Input Offset Voltage measurements are performed by automated test equipment approximately 0.5 seconds after application of power.

**Note 2:** Long-Term Input Offset Stability refers to the average trend line of  $V_{OS}$  vs Time over extended periods after the first 30 days of operation.

**Note 3:** Sample tested.

**Note 4:** Guaranteed by design.

# Low Offset Voltage Operational Amplifier

OP07

## ELECTRICAL CHARACTERISTICS

( $V_S = \pm 15V$ ,  $0^\circ C \leq T_A \leq +70^\circ C$ , unless otherwise noted.)

PARAMETER	SYMBOL	CONDITIONS	OP07E			OP07C			OP07D		
			MIN.	TYP.	MAX.	MIN.	TYP.	MAX.	MIN.	TYP.	MAX.
Input Offset Voltage	$V_{OS}$	(Note 5)	45	130		85	250		85	250	$\mu V$
Average Temperature Coefficient of Input Offset Voltage	$TCV_{OS}$	(Note 6)	0.3	1.3		0.4	1.8		0.7	2.5	$\mu V/^\circ C$
Input Offset Current	$I_{OS}$		0.9	5.3		1.6	8.0		1.6	8.0	nA
Average Input Offset Current Drift	$TCI_{OS}$	(Note 6)	8	35		12	50		12	50	$\mu A/^\circ C$
Input Bias Current	$I_B$		$\pm 1.5$	$\pm 5.5$		$\pm 2.2$	$\pm 9.0$		$\pm 3.0$	$\pm 14$	nA
Average Input Bias Current Drift	$TCI_B$	(Note 6)	13	35		18	50		18	50	$\mu A/^\circ C$
Input Voltage Range	IVR		$\pm 13.0$	$\pm 13.5$		$\pm 13.0$	$\pm 13.5$		$\pm 13.0$	$\pm 13.5$	V
Common-Mode Rejection Ratio	CMRR	$V_{CM} = \pm 13V$	103	123		97	120		94	106	dB
Power Supply Rejection Ratio	PSRR	$V_S = \pm 3V$ to $\pm 18V$	7	32		10	51		10	51	$\mu V/V$
Large Signal Voltage Gain	$A_{VO}$	$R_L \geq 2k\Omega$ , $V_O = \pm 10V$	180	400		100	400		100	400	V/mV
Output Voltage Swing	$V_O$	$R_L \geq 2k\Omega$	$\pm 12.0$	$\pm 12.6$		$\pm 11.0$	$\pm 12.6$		$\pm 11.0$	$\pm 12.6$	V

**Note 5:** Input Offset Voltage is measured 0.5 seconds after application of power.

**Note 6:** Sample tested.

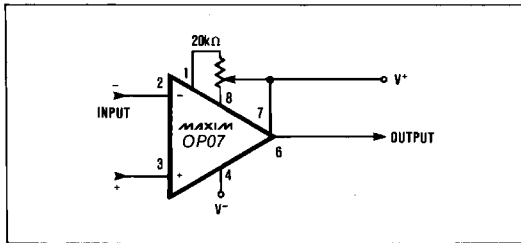

Figure 1. Optional Offset Nulling Circuit.

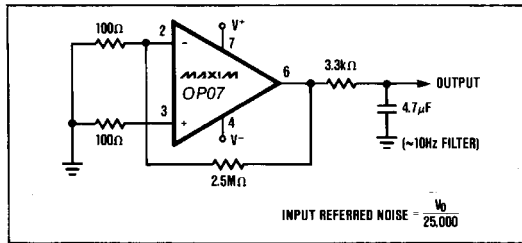
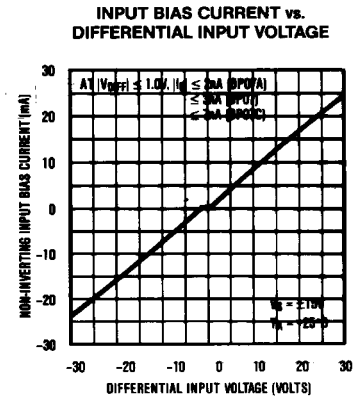
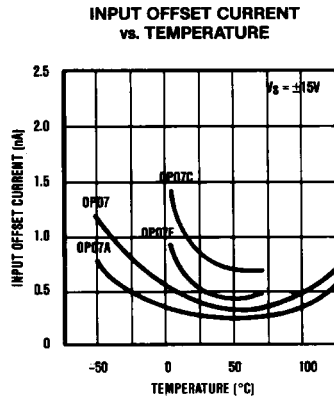
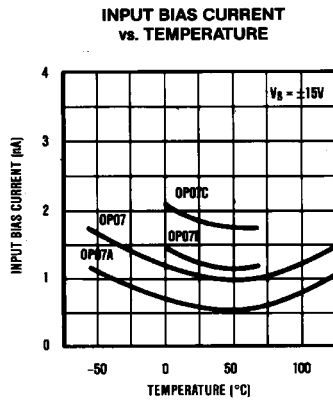
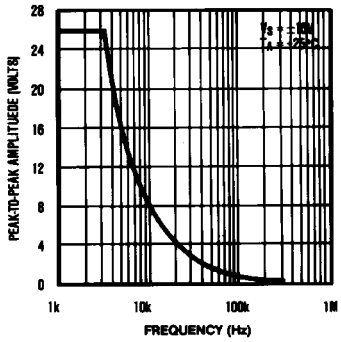

Figure 2. Low Frequency Noise Test Circuit.



# Low Offset Voltage Operational Amplifier

**MAXIMUM OUTPUT SWING vs. FREQUENCY**



**LOW FREQUENCY NOISE**

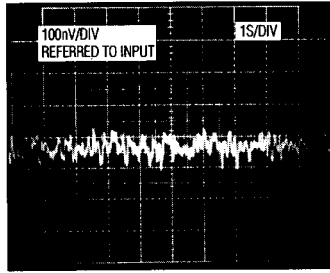

**TOTAL INPUT NOISE VOLTAGE vs. FREQUENCY**

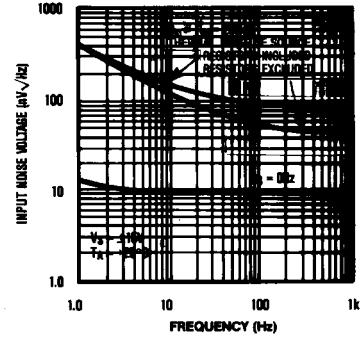

**CMRR vs. FREQUENCY**

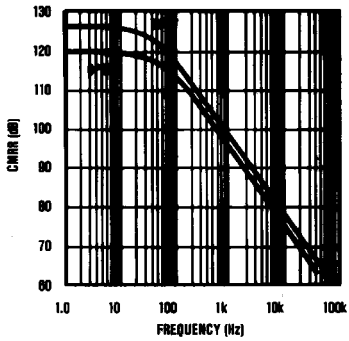

**PSRR vs. FREQUENCY**

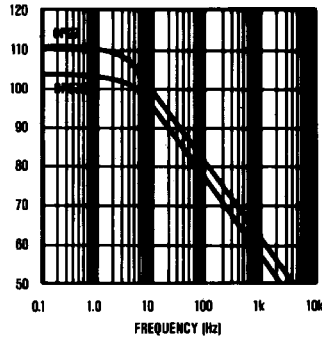

**OPEN LOOP FREQUENCY RESPONSE**

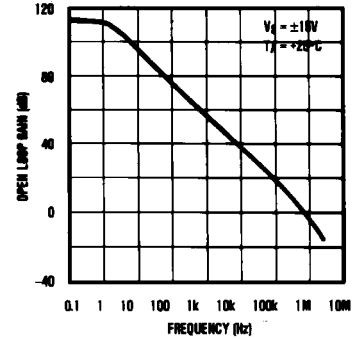

**OFFSET VOLTAGE CHANGE DUE TO THERMAL SHOCK**

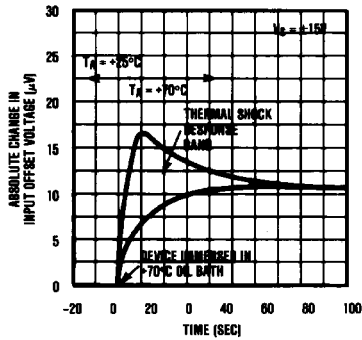

## Chip Topography

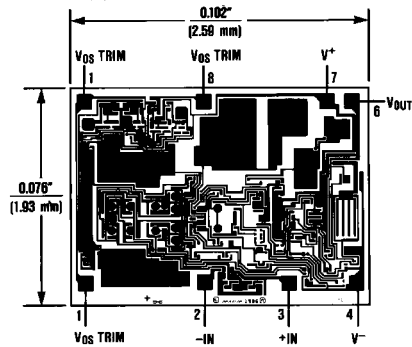

# Low Offset Voltage Operational Amplifier

## Package Information

OP07

